



Merlin 4400 Management Guide

Table of Contents

1. Introduction	11
1.1. Using this Documentation	11
1.2. Information Tables	11
1.3. Diagnostics, Definitions and UCI Commands	12
1.4. Warning Levels	12
2. Product Overview	14
2.1. Product Description	14
2.2. Available Models	14
3. Installation	15
3.1. Mounting the Router	15
3.2. Cooling	15
3.3. Connecting Cables	15
3.4. Connecting the Antenna	15
3.5. Inserting SIM Cards	15
3.5.1. Inserting SIM 1 Card	16
3.5.2. Inserting SIM 2 Card	16
3.6. Powering Up	16
4. Hardware Specification	17
4.1. Hardware overview	17
4.2. Dimensions and Weight	17
4.3. Compliance Information	18
4.3.1. Agency Approvals and Standards Compliance	18
4.4. Specifications	18
4.4.1. Interface Specifications	18
4.4.2. Type Tests and Environmental Conditions	20
4.5. Connector Information	21
4.5.1. Power Input	21
4.5.2. Serial Ports	21
4.5.3. Console Port	22
4.5.4. Antennas	22
4.5.5. SFP Transceivers	23
4.5.6. Reset Button	23
4.6. LED Indicators	24
4.7. Ethernet Port LED Behaviour	25
5. Factory Configuration Extraction from SIM Card	26
6. Accessing the Router	27
6.1. Accessing the Router over Ethernet using the Web Interface	27
6.2. Accessing the Router over Ethernet using an SSH Client	27
6.3. Accessing the Router over Ethernet using a Telnet Client	28
6.4. Configuring the Password	29
6.4.1. Configuring the Password using UCI	30
6.4.2. Configuring the Password using Package Options	30
6.5. Accessing the Device Using RADIUS Authentication	30
6.6. Accessing the Device Using TACACS+ Authentication	32
6.7. SSH	35
6.8. Package Dropbear using UCI	38
6.9. Certs and Private Keys	38
6.10. Configuring a Router's Web Server	39
6.10.1. Main Settings	40
6.11. Basic Authentication (httpd conf)	44
6.12. Securing uhttpd	44
6.13. Displaying Custom Information via Login Screen	45
7. Router File Structure	47

7.1. System Information	47
7.2. Identify Your Software Version	47
7.3. Image Files	48
7.4. Directory Locations for UCI Configuration Files	48
7.5. Viewing and Changing Current Configuration	49
7.6. Configuration File Syntax	49
7.7. Exporting a Configuration File	50
7.7.1. Exporting a Configuration File using the Web Interface for Software Versions pre- 72.002	50
7.7.2. Exporting a Configuration File using the Web Interface for Software Version 72.002 and Above	51
7.7.3. Exporting a Configuration File using UCI	51
7.8. Importing a Configuration File	52
7.8.1. Importing a Configuration File using the Web Interface for Software Versions pre- 72.002	52
7.8.2. Importing a Configuration File using the Web Interface for Software Version 72.002 and Above	53
7.8.3. Importing a Configuration File using UCI	54
8. Using the Command Line Interface	55
8.1. Overview of Some Common Commands	55
8.2. Using Unified Configuration Interface (UCI)	57
8.3. Export a Configuration	59
8.4. Show a Configuration Tree	59
8.5. Display Just the Value of an Option	60
8.6. High Level Image Commands	61
8.7. Format of Multiple Rules	61
8.8. Configuration Files	63
8.9. Configuration File Syntax	63
9. Upgrading Router Firmware	65
9.1. Software Versions	65
9.2. Identify your Software Version	65
9.3. Upgrading Router Firmware For Software Version 72.002 and Above	66
9.4. Upgrading Router Firmware for Software Versions pre-72.002	67
9.5. Flash Image and Do Not Reboot Option	69
9.6. Update Flash Image and Reboot using New Image Immediately Option	69
9.7. Possible File Corruption	70
9.8. Verify the Firmware Has Been Upgraded Successfully	70
9.9. Upgrading Firmware using CLI	70
9.9.1. Flashing	71
9.9.2. Flash Verification after Flashing	71
9.9.3. Set up an Alternative Image	72
10. System Settings	73
10.1. Syslog Overview	73
10.2. Configuring System Properties	73
10.2.1. General Settings	74
10.2.2. Logging	75
10.2.3. Language and Style	78
10.2.4. Audit Configuration	78
10.2.5. Time Synchronization	79
10.2.6. Console Login Banner	81
10.2.7. System Reboot	82
10.3. System Settings Using Command Line	82
10.3.1. System Settings using UCI	83
10.4. System Diagnostics	84
10.4.1. System Log Messages in RAM	85

10.4.2. System Log Messages in Flash	85
10.4.3. Kernel Messages	86
10.4.4. Syslog Process	87
10.4.5. NTP Process	87
10.5. Advanced Filtering of Syslog Messages	87
10.5.1. Advanced Filtering Using Command Line	87
10.5.2. Filter Definitions	88
11. Configuring an Ethernet Interface	91
11.1. Configuring an Ethernet Interface using the Web Interface	91
11.1.1. Interface Overview: Editing an Existing Interface	92
11.1.2. Interface Overview: Creating a New Interface	92
11.1.3. Interface Overview: Common Configuration	93
11.2. Interface Overview: IP-aliases	100
11.2.1. IP-alias using the Web	100
11.2.2. IP-aliases: General Setup	101
11.2.3. IP-aliases: Advanced Settings	102
11.3. Interface Overview: DHCP Server	102
11.3.1. DHCP Server: General Setup	103
11.3.2. DHCP Server: Advanced Settings	105
11.4. Interface Configuration using Command Line	105
11.4.1. Interface Configuration using Package Options	107
11.4.2. Loopback Interfaces UCI	108
11.5. Configuring Port Maps using the Web Interface	108
11.6. Configuring Port Maps using UCI	109
11.7. Configuring Port Map using Package Options	110
11.8. Interface Diagnostics	110
11.9. Route Status	112
11.10. ARP Table Status	112
12. Configuring VLAN	113
12.1. Configuring VLAN using the Web Interface	113
12.2. General Setup: VLAN	115
12.3. Firewall Settings: VLAN	116
12.4. Viewing VLAN Interface Settings	117
12.5. Configuring VLAN using UCI	117
13. Configuring Mobile Manager	119
13.1. Configuring Mobile Manager using the Web Interface	119
13.1.1. Mobile Manager: Basic Settings	119
13.1.2. Mobile Manager: Advanced Settings	120
13.1.3. Mobile Manager: LTE Settings	122
13.1.4. Mobile Manager: CDMA Settings	124
13.1.5. Mobile Manager: Callers	127
13.2. Configuring Mobile Manager using UCI	127
13.3. Monitoring SMS	129
13.3.1. Sending SMS from the Router	130
13.3.2. Sending SMS to the Router	130
14. Configuring multi-APNs for Mobile Interfaces	131
14.1. Multi-APN Overview	131
14.2. Configuring multi-APN using the Web Interface	131
14.3. Configuring multi-APN using the Command Line	133
14.3.1. Configuring Multi-APN using UCI	133
14.4. Multi-APN Diagnostics	135
14.4.1. Routing table	136
15. Configuring a GRE Interface	138
15.1. Creating a GRE Connection using the Web Interface	138
15.1.1. GRE Connection: Common Configuration: General Setup	140

15.1.2. Configuring IPv6 Routes using the Web Interface	141
15.1.3. GRE Connection: Common Configuration-advanced Settings	142
15.1.4. GRE Connection: Firewall Settings	143
15.1.5. GRE Connection: Adding a Static Route	144
15.2. Configuring GRE using UCI	144
15.3. GRE Diagnostics	146
16. Configuring VRF (Virtual Router Forwarding)	149
16.1. Configuring VRF using the Web Interface	149
16.1.1. Configuring a VRF on a Static Route	151
16.2. Configuring the VRFs using the Command Line	151
16.2.1. VRF using UCI	152
16.3. VRF Diagnostics	152
17. Configuring Static Routes	154
17.1. Configuring Static Routes using the Web Interface	154
17.2. Configuring Routes using Command Line	155
17.3. IPv4 Routes using UCI	156
17.4. IPv6 Routes using UCI	156
17.5. Static Routes Diagnostics	157
17.6. Configuring IPv6 Routes using the Web Interface	157
18. Configuring BGP (Border Gateway Protocol)	159
18.1. Configuring BGP using the Web Interface	159
18.2. Optionally Configure a BGP Route Map	161
18.3. Configure BGP Neighbours	163
18.4. Configuring BGP using Command Line	164
18.5. View Routes Statistics	166
19. Configuring OSPF	168
19.1. OSPF Areas	168
19.2. OSPF Neighbours	169
19.3. OSPF Designated Routers	169
19.4. OSPF Neighbour States	170
19.5. OSPF Network Types	170
19.6. The OSPF Hierarchy	171
19.7. OSPF Router Types	172
19.8. Configuring OSPF using the Web Interface	172
19.8.1. Global Settings	173
19.8.2. Topology Configuration	174
19.8.3. Interfaces Configuration	175
19.9. Configuring OSPF using the Command Line	178
19.10. Configuring OSPF using UCI	179
19.11. OSPF Diagnostics	180
19.11.1. Quagga/Zebra Console OSPF	181
19.11.2. OSPF Debug Console	182
20. Configuring VRRP	187
20.1. Configuring Static Routes using the Web Interface	187
20.2. Configuring VRRP using the Web Interface	188
20.3. VRRP Global Settings	188
20.4. VRRP Group Configuration Settings	189
20.5. Configuring VRRP using Command Line	192
20.5.1. VRRP using UCI	193
20.6. VRRP Diagnostics	194
21. Configuring RIP	195
21.1. RIP characteristics	195
21.2. RIP Versions	195
21.3. Configuring RIP using the Web Interface	196
21.3.1. RIP Interfaces Configuration	199

21.3.2. Offset Configuration	200
21.3.3. MD5 authentication key chains	201
21.4. Configuring RIP using Command Line	201
21.4.1. RIP using UCI	203
21.4.2. RIP using Package Options	204
21.5. RIP Diagnostics	205
21.5.1. Tracing RIP Packets	206
21.5.2. Quagga/Zebra console RIP	206
21.5.3. RIP Debug Console	207
22. Configuring PIM and IGMP Interfaces	209
22.1. Configuring PIM and IGMP using the Web Interface	209
22.1.1. Global Settings	210
22.1.2. Interfaces Configuration	210
22.2. Configuring PIM and IGMP using UCI	210
23. Configuring Multi-WAN	212
23.1. Configuring Multi-WAN using the Web Interface	212
23.2. Configuring Multi-WAN using UCI	217
23.3. Multi-WAN Diagnostics	219
24. Automatic Operator Selection	222
24.1. Configuring Automatic Selection via the Web Interface	222
24.1.1. Scenario 1: PMP + Roaming: Pre-empt Enabled	222
24.2. Mobile Manager: Basic Settings	232
24.3. Mobile Manager: Advanced Settings	233
24.4. Mobile Manager: CDMA Settings	234
24.5. Mobile Manager: Callers	237
24.6. Roaming Interface Template: Web Interface	239
24.7. Scenario 2: PMP + Roaming: Pre-empt Disabled	242
24.7.1. Set Multi-WAN Options for Pre-empt Disabled	243
24.8. Scenario 3: No PMP + Roaming	243
24.8.1. Set Options for Automatically Created Interfaces (failover)	244
24.8.2. Basic Settings	244
24.8.3. Caller Settings	245
24.8.4. Configuring no PMP + Roaming using UCI	245
24.8.5. Roaming Interface Template: Web Interface	248
24.8.6. Set Multi-WAN Options for Primary Predefined Interface	251
24.9. Configuring Automatic Operator Selection via UCI	256
24.9.1. PMP + Roaming: Pre-empt & Disabled using UCI	256
24.9.2. Configuring no PMP + Roaming using UCI	262
24.9.3. Automatic Operator Selection Diagnostics via the Web Interface	265
24.10. Automatic Operator Selection Diagnostics via UCI	266
24.10.1. Check Roaming Interfaces Discovered	266
24.10.2. Check Interfaces created in multiwan Package	267
24.10.3. Check Interfaces Created in Network Package	268
24.10.4. Check Current Interface	269
25. Configuring Connection Watch (cwatch)	271
25.1. Configuring Connection Watch using the Web Interface	271
25.2. Configuring cwatch using Command Line	274
25.2.1. cwatch using UCI	275
25.3. cwatch Diagnostics	275
26. Configuring DHCP Server and DNS (Dnsmasq)	277
26.1. Configuring IPv6 Routes using the Web Interface	277
26.2. Configuring DHCP and DNS using the Web Interface	278
26.2.1. Dnsmasq: General Settings	279
26.2.2. Dnsmasq: Resolv and Host Files	280
26.2.3. Dnsmasq: TFTP Settings	281

26.2.4. Dnsmasq: Advanced Settings	282
26.2.5. Active Leases	284
26.2.6. Static Leases: DHCP Server and DNS	284
26.2.7. Configuring DHCP Pools using the Web Interface	285
26.3. Configuring DHCP and DNS using Command Line	287
26.3.1. Configuring Static Leases using Command Line	288
26.3.2. Configuring DHCP Pools using Command Line	288
27. Configuring DHCP Client	290
27.1. Configuring DHCP Client using the Web Interface	290
27.1.1. Creating a New Interface for DHCP Client	291
27.2. Common Configuration	292
27.2.1. Common Configuration: General Setup	293
27.2.2. Common Configuration: Advanced Settings	295
27.3. Configuring DHCP Client using Command Line	297
27.4. DHCP Client Diagnostics	298
28. Configuring DHCP Forwarding	300
28.1. Configuring DHCP using the Web Interface	300
28.2. Configuring DHCP Forwarding using Command Line	301
28.3. DHCP Forwarding over IPSec	302
28.3.1. Configuring Source NAT for DHCP Forwarding over IPSec	302
28.4. Configuring Source NAT for DHCP Forwarding over IPSec	304
28.5. Configuring Source NAT for DHCP Forwarding over IPSec using Command Line ..	307
28.6. DHCP Forwarding Diagnostics	308
29. Configuring Dynamic DNS	310
29.1. Configuring Dynamic DNS using the Web Interface	310
29.2. Dynamic DNS using UCI	313
30. Configuring Host Names	315
30.1. Configuring Local Host Files Entries using the Web Interface	315
30.2. Local Host Records using Command Line	316
30.3. Local Host Records Diagnostics	317
30.4. Configuring PTR Records using the Web Interface	317
30.5. PTR Records using Command Line	318
30.6. PTR Records Diagnostics	318
30.7. Configuring Static Leases using the Web Interface	319
30.8. Configuring Static Leases using Command Line	320
31. Configuring Firewall	322
31.1. Scenario 3: No PMP + Roaming	322
31.2. Configuring Firewall using the Web Interface	322
31.2.1. Firewall - Zone Settings - General Settings page	323
31.2.2. Firewall Port Forwards Page	329
31.2.3. Firewall Traffic Rules Page	333
31.3. Configuring Firewall using UCI	337
31.3.1. Implications of DROP vs. REJECT	341
31.3.2. Connection Tracking	341
31.3.3. Firewall Rule Examples	342
32. Configuring IPSec	349
32.1. Configuring IPSec using the Web Interface	349
32.1.1. Configure Common Settings using the Web Interface	350
32.1.2. Common Settings: Configure Connection using Web Interface	351
32.1.3. Common Settings: IP Addressing using the Web Interface	352
32.2. Common Settings: IPSec Settings using the Web Interface	354
32.3. Configure Secret Settings using the Web Interface	357
32.4. Configuring an IPSec Template for DMVPN via the Web Interface	358
32.5. Configuring IPSec using UCI	358
32.6. Shunt Connection using UCI	361

32.7. Secret Settings using UCI	362
32.8. Configuring an IPSec Template to use with DMVPN using UCI	363
32.9. IPSec Diagnostics	365
33. Configuring SCEP (Simple Certificate Enrolment Protocol)	367
33.1. Configuring SCEP using the Web Interface	367
33.2. Configuring SCEP Certificate using the Command Line	370
33.3. SCEP Diagnostics	373
33.4. Strongswan Process using UCI	374
34. Dynamic Multipoint Virtual Private Network (DMVPN)	375
34.1. Configuring DMVPN using the Web Interface	375
34.2. DMVPN Scenarios	377
34.3. Configuring DMVPN using the Web Interface	379
34.4. DMVPN Diagnostics	381
35. Configuring QoS: VLAN PCP Tagging	385
36. Management Configuration Settings	388
36.1. Autoload: Boot up Activation	388
36.2. Autoload using UCI	391
36.3. HTTP Client: Configuring Activation using the Web Interface	392
36.4. Httpclient: Activator Configuration using UCI	396
36.5. User management using UCI	397
36.6. Configuring Management User Password using UCI	399
36.7. Configuring User Access to Specific Web Pages	400
37. Configuring Monitor	401
37.1. Reporting Device Status to Monitor	401
37.2. Configuring Keepalive Heartbeat using the Web Interface	401
37.3. Configuring keepalive heartbeat using command line	404
37.4. Enabling Interface Status in Keepalive Heartbeat via Web Interface	406
37.5. Enable Interface Status using UCI	407
37.6. Reporting GPS Location to Monitor	407
37.7. GPS Diagnostics	408
37.8. Reporting Syslog to Monitor	409
37.9. Configuring Syslog Events to Monitor using Command Line	410
37.10. Configuring ISAD	411
37.11. ISAD Diagnostics	413
37.12. Speedtest Reporting	414
38. Configuring SNMP	416
38.1. Configuring SNMP using the Web Interface	416
38.1.1. Com2Sec Settings	417
38.1.2. Group Settings using the Web Interface	418
38.1.3. View Settings	418
38.1.4. Access Settings using the Web Interface	419
38.1.5. Trap Receiver	420
38.1.6. Inform Receiver using the Web Interface	421
38.1.7. USM user using Web Interface	421
38.2. Configuring SNMP using Command Line	422
38.2.1. Com2sec using UCI	423
38.2.2. Group Settings using Command Line	424
38.2.3. View Settings using UCI	426
38.2.4. Access Settings Using Command Line	427
38.2.5. SNMP Traps Settings using Command Line	428
38.2.6. SNMP Inform Receiver Settings using Command Line	429
38.2.7. SNMP USM User Settings	430
38.3. Configuring SNMP Interface Alias with Static SNMP Index	431
38.4. Automatic SNMP Traps	432
38.5. SNMP diagnostics	432

39. Event System	435
39.1. Implementation of the Event System	435
39.2. Configuring the Event System using the Web Interface	436
39.3. Connection Tester	436
39.4. Event Destination	437
39.4.1. Syslog Target	438
39.4.2. Email Target	439
39.4.3. SNMP Target	442
39.4.4. Exec Target	444
39.4.5. SMS Target	445
39.4.6. File Target	446
39.5. Event Filters	447
39.6. Configuring the Event System using Command Line	448
39.6.1. Event System using UCI	450
39.7. Event System Diagnostics	457
40. Configuring Data usage Monitor	461
40.1. Configuring Data using the Web Interface	461
40.2. Configuring Data using Command line	463
40.3. Data Usage Diagnostics	464
41. Configuring Terminal Server	466
41.1. Configuring Terminal Server using the Web Interface	466
41.1.1. Configuring Port Settings	467
41.2. Configuring Terminal Server using UCI	481
41.3. Configuring Terminal Server DSR Signal Management Network	481
41.4. Serial Mode GPIO Control	483
41.5. Terminal server diagnostics	483
42. Configuring Terminal Package	486
42.1. Configuring Terminal Package using UCI	486
42.2. Terminal Diagnostics	487
43. Configuring RTUD	488
43.1. Configuring RTUD using the Web Interface	488
43.1.1. Configuring RTUD General Options	490
43.1.2. Configure RTUD Advanced Options	491
43.1.3. Configuring RTUD IEC104 Options	492
43.1.4. Configure RTUD DNP3 Options	494
43.1.5. Configure RTUD Modbus Options	495
43.2. Controlling the RTUD Application Manually using the Web Interface	495
43.3. Configuring RTUD using Command Line	496
43.4. RTUD Diagnostics	498
44. SCADA IEC 104 Gateway	500
44.1. IEC 104 Gateway Configuration using the Web Interface	501
44.1.1. Main Settings	502
44.1.2. Port Settings	502
44.1.3. Port Settings: General	503
44.1.4. Port settings: IEC 104	503
44.1.5. Port Settings: IEC 101	506
44.1.6. Port Settings: DNP3	509
44.1.7. Port Settings: Modbus	512
44.1.8. Port Settings: Advanced	513
44.2. IEC 101 Links	515
44.3. Point Mappings	515
44.4. IEC 104 Gateway Configuration using Command Line	519
44.5. IEC 104 to IEC 101 Conversion (Balanced or Unbalanced)	520
44.6. IEC104 to Modbus Conversion	524
44.6.1. IEC104 to Modbus using UCI	526

44.7. Configuring the Terminal Server	529
44.7.1. Configuring the Terminal Server for IEC104 to DNP3	534
44.7.2. Configuring the Terminal Server for IEC 104 to Modbus over Serial	534
44.8. Configuring IEC61850 to IEC101 Conversion	540
44.8.1. IEC 61850 to IEC 101 Conversion using UCI	543
44.9. SCADA IEC 104 Gateway Diagnostics	547
45. DNP3 Outstation Application	550
45.1. Configuring DNP3 Outstation using the Web Interface	550
45.2. Configuring DNP3 Outstation using Command Line	551
45.3. DNP3 Outstation Diagnostics	552
46. Serial Interface	554
46.1. Monitoring Serial Interfaces using the Web Interface	554
46.2. Set Options for Automatically Created Interfaces (failover)	555
46.3. Monitoring Serial Interfaces using Command Line	555

1. Introduction

This document covers models in the Merlin 4400 Series. For general references, we refer to the Merlin Series throughout.

1.1. Using This Documentation

You can configure your router using either the router's web interface or via the command line using UCI commands. Each chapter explains first the web interface settings, followed by how to configure the router using UCI. The web interface screens are shown along with a path to the screen for example, 'In the top menu, select **Service -> SNMP**.' followed by a screen grab.

After the screen grab there is an information table that describes each of the screen's fields.

1.2. Information Tables

We use information tables to show the different ways to configure the router using the router's web and command line. The left-hand column shows three options:

- **Web:** refers the command on the router's web page,
- **UCI:** shows the specific UCI command, and
- **Opt:** shows the package option.

The right-hand column shows a description field that describes the feature's field or command and shows any options for that feature.

Some features have a drop-down menu and the options are described in a table within the description column.

Values for enabling and disabling a feature are varied throughout the web interface, for example, 1/0; Yes/No; True/False; check/uncheck a radio button. In the table descriptions, we use **0** to denote Disable and **1** to denote Enable.

Some configuration sections can be defined more than once. An example of this is the routing table where multiple routes can exist and all are named 'route'. For these sections, the UCI command will have a code value **[0]** or **[x]** (where x is the section number) to identify the section.

Web Field/UCI/Package Option	Description
Web: Metric	Specifies the route metric to use.
UCI: network.@route[0].metric	
Opt: metric	



NOTE

These sections can be given a label for identification when using UCI or package options.

```
network.@route[0]=route
network.@route[0].metric=0
```

can be written as:

```
network.routename=route
network.routename.metric=0
```

However, the documentation usually assumes that a section label is not configured.

The table below shows fields from a variety of chapters to illustrate the explanations above.

Web Field/UCI/Package Option	Description																
Web: Enable UCI: cesop.main.enable Opt: enable	Enables CESoPSN services. <table border="1"> <tr> <td>Default: 0</td> <td>Disabled</td> </tr> <tr> <td>1</td> <td>Enabled</td> </tr> </table>	Default: 0	Disabled	1	Enabled												
Default: 0	Disabled																
1	Enabled																
Web: Syslog Severity UCI: cesop.main.severity Opt: log_severity	Selects the severity used for logging events CESoPSN in syslog. The following levels are available: <table border="1"> <tr> <td>0</td> <td>Emergency</td> </tr> <tr> <td>1</td> <td>Alert</td> </tr> <tr> <td>2</td> <td>Critical</td> </tr> <tr> <td>3</td> <td>Error</td> </tr> <tr> <td>4</td> <td>Warning</td> </tr> <tr> <td>5</td> <td>Notice</td> </tr> <tr> <td>6</td> <td>Informational</td> </tr> <tr> <td>7</td> <td>Debug</td> </tr> </table>	0	Emergency	1	Alert	2	Critical	3	Error	4	Warning	5	Notice	6	Informational	7	Debug
0	Emergency																
1	Alert																
2	Critical																
3	Error																
4	Warning																
5	Notice																
6	Informational																
7	Debug																
Web: Agent Address UCI: snmpd.agent[0].agentaddress Opt: agentaddress	Specifies the address(es) and port(s) on which the agent should listen. [(udp tcp):]port[@address][:##]																

1.3. Diagnostics, Definitions And UCI Commands

Diagnostics

Diagnostics are explained at the end of each feature's chapter.

Definitions

Throughout the document, we use the host name 'VA_router' to cover all router models.

UCI Commands

UCI commands and package option examples are shown using the following format:

```
root@VA_Router:~# vacmd show current config
```

For detailed information on using UCI commands, read chapters 'Router File Structure', and 'Using Command Line Interface'.

1.4. Warning Levels

Warning signs are provided to prevent personal injuries and/or damages to the product. The following levels are used:



Level of warning	Description	Consequence personal injury	Consequence material damage
 WARNING	Indicates a potentially hazardous situation	Possible death or major injury	Major damage to the product
 CAUTION	Indicates a potentially hazardous situation	Minor or moderate injury	Moderate damage to the product
 NOTICE	Provides information in order to avoid misuse of the product, confusion or misunderstanding	No personal injury	Minor damage to the product
 NOTE	Used for highlighting general, but important information	No personal injury	Minor damage to the product

Table 1. Warning levels

2. Product Overview

2.1. Product Description

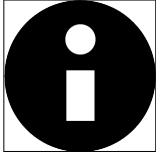
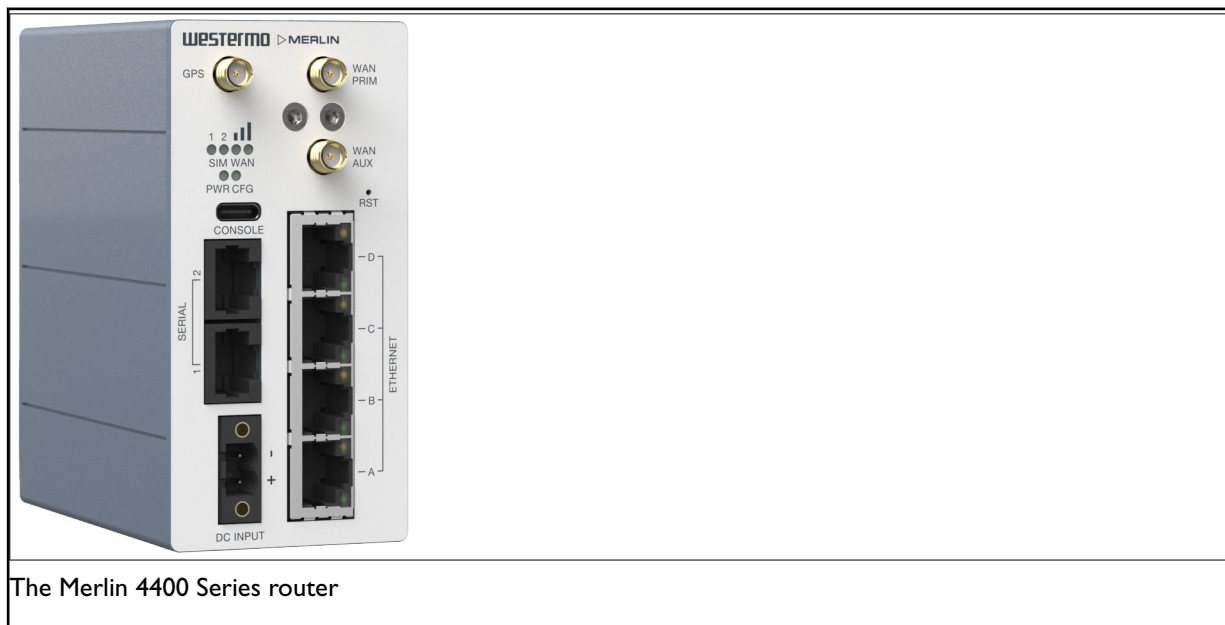

The Merlin 4400 series of versatile cellular routers is designed from the ground up to achieve best-in-class Cybersecurity both in hardware and software. A tamper-resistant chip keeps cryptographic keys secure. Secure Boot guarantees that the unit boots using only software that is signed and trusted by Westermo. A set of cybersecurity tools is available as standard. High security VPNs, stateful inspection firewall, user authentication and 802.1x are just a few of the features available to keep the device secure both locally and when transmitting data over the internet or private network.

Legacy serial (RS-232/485) ports allow the Merlin 4400 to be used in applications where it is necessary to migrate from modems to an IP infrastructure. The built-in industrial protocol gateway enables several devices using different protocols to be accessed via a common protocol interface.

The Merlin 4400, like all the members of the Merlin family, is compatible with the Activator zero-touch deployment software. The Activator software ensures that configurations are generated and deployed from a central server, reducing configuration mistakes and increasing efficiency during the installation phase of a project.

This compact unit is suited to tight spaces. Its high MTBF, wide temperature range and voltage supply ensure the Merlin can deal with the demands of industrial, smart grid and trackside applications.

2.2. Available Models

See datasheet for full list of models available.

3. Installation

3.1. Mounting The Router

The router is fitted with a DIN-rail clip by default. To attach the router to a DIN-rail:

1. Position the router so that the spring of the DIN-clip rests on the DIN-rail.
2. Push the router in an upward direction so that the spring of the DIN-clip compresses and the top hook of the DIN-clip slides and clamps to the DIN-rail.

To remove the router from the DIN-rail, simply reverse the procedure.



MOUNTING HEIGHT

To reduce the risk of personal injury and damage to the device, the unit must not be mounted at a height greater than two metres above the ground beneath it.

3.2. Cooling

This product uses convection cooling. Spacing is recommended for the use of the product in full operating temperature range and service life. To avoid obstructing the airflow around the product, use the following spacing rules.

Minimum spacing of 25 mm (1 inch) above/below and 10 mm (0.4 inches) left/right of the product is recommended.



REDUCE THE RISK OF FIRE

To reduce the risk of fire, use only telecommunication line cords with a cable diameter of AWG 26 or larger. Regarding power cable dimensions, see chapter Interface Specifications.

3.3. Connecting Cables

Connect one end of the Ethernet cable into port A and the other end to your PC or switch.

3.4. Connecting The Antenna

If only connecting one LTE antenna, screw the antenna into the MAIN SMA connector. If you are using more than one LTE antenna, screw the main antenna into the MAIN SMA connector and the secondary antenna into the WAN-AUX SMA connector.

3.5. Inserting SIM Cards

On the rear side of the router there are two SIM slots. To access the SIM cards, first remove the SIM cover using a suitable screwdriver (not supplied). Only the proper driver can drive a specific head size without risk of damaging the driver or screw.

3.5.1. Inserting SIM 1 Card

Ensure the router is powered off.

- Remove the SIM cover using a suitable screwdriver.
- Hold the SIM 1 card with the chip side facing down and the cut corner facing away from you, to the left.
- Gently push the SIM card into the upper SIM slot 1 until it clicks in.
- Screw the SIM cover back on with the screwdriver.

3.5.2. Inserting SIM 2 Card

- If you are using a second SIM, hold the SIM 2 card with the chip side facing up and the cut corner front right facing away from you.
- Gently push the SIM card into the lower SIM slot 2 until it clicks in.
- Screw the SIM cover back on with the screwdriver.

3.6. Powering Up

Plug the power cable first into the device and then to a suitable power source. The router takes less than a minute to boot up. During this time, the power LED flashes.

Other LEDs display different diagnostic patterns during boot up. Booting is complete when the power LED stops flashing and stays on steady.

4. Hardware Specification

4.1. Hardware Overview

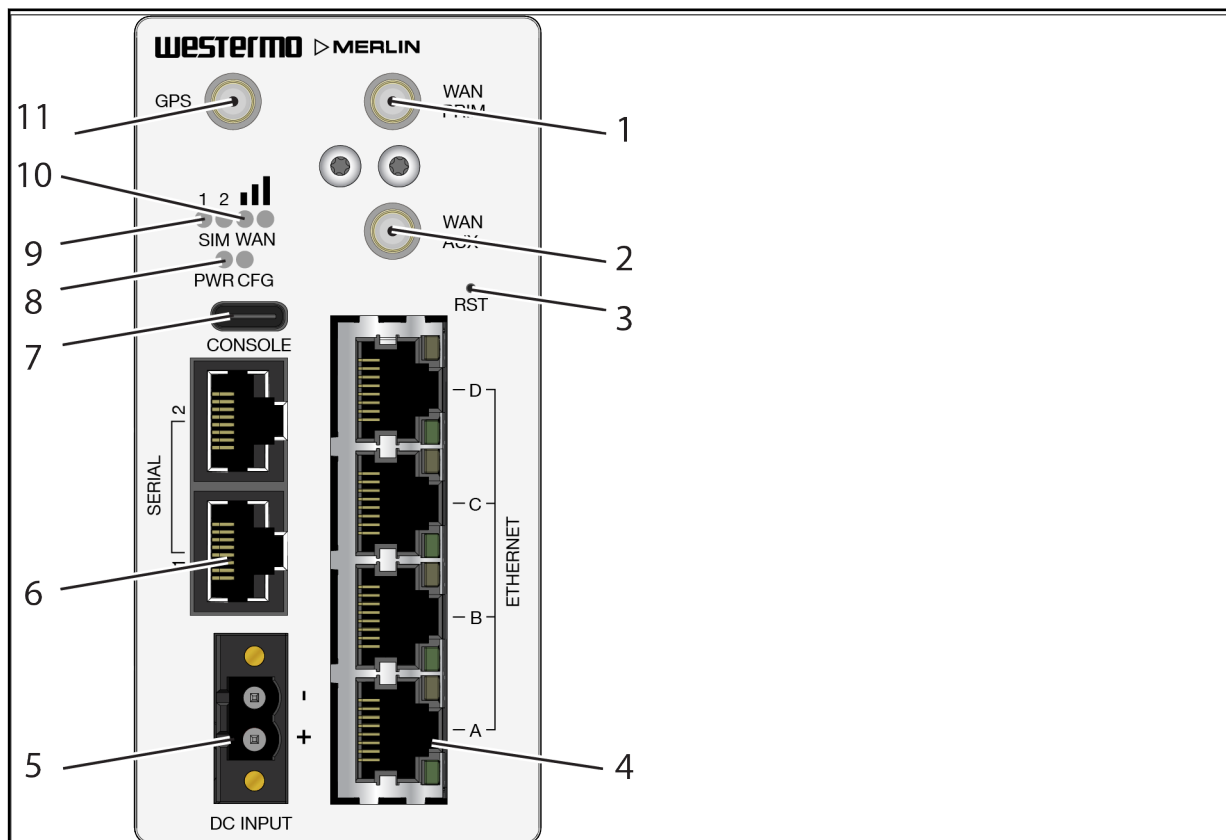
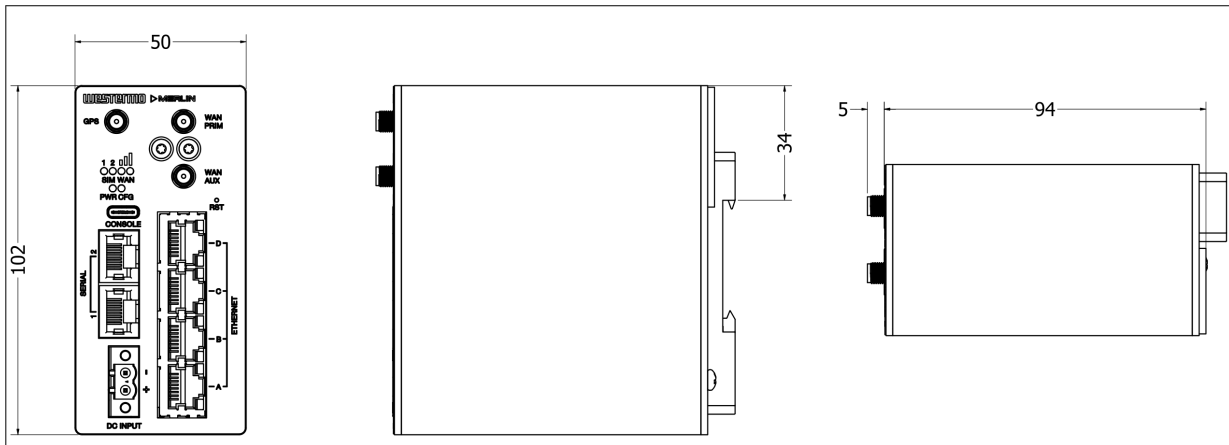

Figure 1. Location of interface ports and LEDs, illustrated by a Merlin-4407-T4-S2-LV model

No.	Description	No.	Description
1	WAN primary SMA connector	2	WAN auxiliary SMA connector
3	Reset button	4	Ethernet RJ45 ports
5	Power connection	6	Serial ports
7	USB-C Console port	8	Power and configuration LEDs
9	SIM LEDs	10	WAN signal strength
11	GPS SMA connector		

4.2. Dimensions And Weight

Unit size:	50W 100D 102H mm
Unit weight:	Approx 500g



4.3. Compliance Information

4.3.1. Agency Approvals And Standards Compliance

Type	Approval/Compliance
EMC	<ul style="list-style-type: none"> EN/IEC 61000-6-2, Immunity industrial environments EN/IEC 61000-6-4, Emission industrial environments EN 50121-4, Railway signalling and telecommunications apparatus (pending) IEC 61850-3, Communication networks and systems for power utility automation – Part 3: General requirements
Safety	<ul style="list-style-type: none"> EN 62368-1, Safety Communication Technology UL 62368 (pending)
North American standards/approvals	<ul style="list-style-type: none"> UL 62368-1, FCC, PTCRB, AT&T, Verizon, T-Mobile (all pending)

Table 2. Agency approvals and standards compliance

4.4. Specifications

4.4.1. Interface Specifications

DC, Power port	
Operating voltage	9.6 to 60 VDC
Rated current	325 mA at 12 VDC 103 mA at 48 VDC
Rated frequency	DC
Inrush current	$2.74 \times 10^{-3} \text{ A}^2\text{s}$ at 12 VDC
Polarity	Reverse polarity protected
Redundant power input	No
Isolation	All other ports
Connector	Push-in spring connectors
Conductor cross section	0.2-2.5 mm ² (AWG 24-12)
Stripping length cable	7 mm
Tightening torque, screw flange	0.3 Nm
Shielded cable	Not required

Ethernet TX	
Electrical specification	IEEE std 802.3
Data rate	10 Mbit/s, 100 Mbit/s, manual or auto
Duplex	Full or half, manual or auto
Circuit type	TNV-1
Transmission range	Up to 150 m with CAT5e cable or better
Isolation	All other ports
Connection	RJ-45, auto MDI/MDI-X
Cabling	Shielded CAT5e or better is recommended
Number of ports	4

RS-232/485	
Electrical specification	Configurable for EIA RS-232 or EIA RS-422/485
Data rate	RS-232: 50 bit/s - 1 Mbit/s
	RS-485: 50 bit/s - 12 Mbit/s
Data format	7 or 8 data bits, odd, even or none parity, 1 or 2 stop bits (2 stop bits only when no parity is set)
Circuit type	TNV-1
Transmission range	RS-232: 15 m/49 ft
	RS-485: Up to 1200 m/0.74 mi, depending on data rate and cable type
Number of ports	Up to 2
Connection	RJ-45 according to EIA-561
	RJ-45 shielded cable

Console port	
Electrical specification	USB 2.0 host interface
Data rate	115.2 kbit/s
Circuit type	SELV
Data format	8 data bits, no parity, 1 stop bit, no flow control
Connection	USB receptacle connector type C

4.4.2. Type Tests And Environmental Conditions

Environmental phenomena	Basic standard	Description	Test levels
ESD	EN 61000-4-2	Enclosure	Contact: ± 6 kV Air: ± 8 kV
Fast transients	EN 61000-4-4	Power port	± 4 kV, direct coupling
		Ethernet ports	± 4 kV, capacitive coupling clamp
		Earth	
		Serial ports	
Surge	EN 61000-4-5	Power port	L-E: ± 2 kV, 12Ω , $9 \mu\text{F}$, $1.2/50 \mu\text{s}$ L-E: ± 2 kV, 42Ω , $0.5 \mu\text{F}$, $1.2/50 \mu\text{s}$ L-L: ± 1 kV, 2Ω , $18 \mu\text{F}$, $1.2/50 \mu\text{s}$ L-L: ± 1 kV, 42Ω , $0.5 \mu\text{F}$, $1.2/50 \mu\text{s}$
		Ethernet ports	L-E: ± 2 kV, 2Ω , direct on shield, $1.2/50 \mu\text{s}$
		RS-232	L-E: ± 2 kV, 2Ω , $0.5 \mu\text{F}$
		RS-422/485	L-E: ± 2 kV, 42Ω , $0.5 \mu\text{F}$
Power frequency magnetic field	EN 61000-4-8	Enclosure	100 A/m; 50 Hz
Radiated RF immunity	EN 61000-4-3	Enclosure	20 V/m at 800 MHz to 1 GHz 10 V/m at 80 MHz to 3 GHz 5 V/m at 2.7 GHz to 6 GHz 1 kHz sine, 80% AM
Conducted RF immunity	EN 61000-4-6	Power port	10 V, 80% AM, 1 kHz; 0.15 MHz to 80 MHz
		Ethernet	
		Serial ports	
		Earth	
Radiated RF emission	EN 55032, EN 61000-6-4	Enclosure	30 MHz to 12 GHz
Conducted RF emission	EN 55032, EN 61000-6-4	Power port	150 kHz to 30 MHz
		Ethernet	150 kHz to 30 MHz
Dielectric strength	UL 62368-1	Power port to all other ports	1.0 kVDC, 1 min
	UL 62368-1 IEEE 802.3	Ethernet TX to all other ports	1.5 kVrms, 50 Hz, 1 min

Table 3. EMC and electrical conditions

Environmental phenomena	Basic standard	Description	Test levels
Temperatures	EN 60068-2-1 EN 60068-2-2	Operational	-40 to +70°C (-40 to +158°F) ^a
Humidity	EN 60068-2-30	Operational	5-95 % relative humidity
MTBF	Telcordia	Ground benign, 25°C	1,600,000 hours
Enclosure	EN 62368-1	Aluminium	Fire enclosure
Weight			0.5 kg
Cooling			Convection

^aRefer to "Safety Information" chapter regarding touch temperature

Table 4. Environmental and mechanical conditions

4.5. Connector Information

4.5.1. Power Input

Illustration	Position	Product marking	Direction	Description
	1	DC+	Input	Supply voltage
	2	DC-	Input	Supply voltage

Table 5. Power input

The positive input is marked with a plus sign, "+". The negative input is marked with a minus sign, "-". Connect the voltage to the + pin and the return to the - pin on the power input.

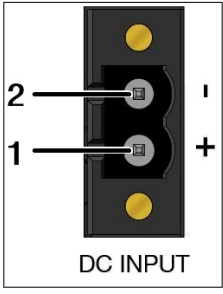

NOTICE - POWER SUPPLY

Where an AC/DC-adaptor has not been supplied, a power supply of no greater than 100 W should be used, with a current limit of 1 Amp.

4.5.2. Serial Ports

A pair of asynchronous serial ports may be present on the router. The serial ports are named as follows, also their identifiers for use within the terminal server configuration:

Label	tservd.port.serialPortName
SERIAL 1	serial1
SERIAL 2	serial2

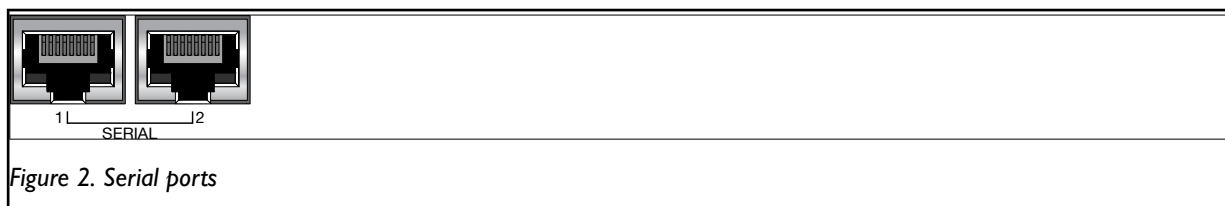

Serial 1 port operates in RS-232 mode. Serial 2 port is software configurable to operate in either RS-232 or RS-485 mode.

The pin numbering of the serial port connector is shown below.

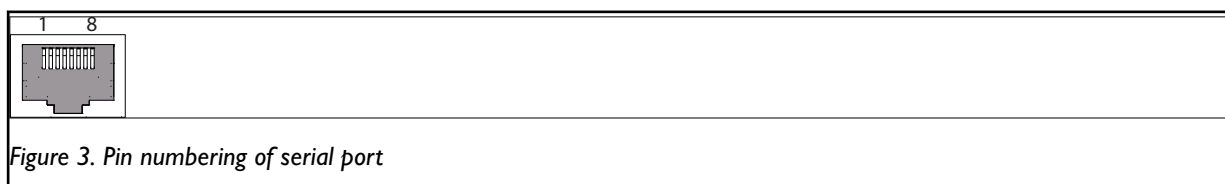

RS-232 Ports

When you configure a serial port to operate as an RS-232 interface, it supports the following signals:

- Transmit Data
- Receive Data
- CTS
- RTS
- DSR
- DTR

The pin numbering of the RJ45 socket, when viewed from the front of the unit, is as shown below. The RS-232 interface is wired as a DCE.

Illustration	Pin no.	Signal	Direction	Description
	1	DSR	Out	Data Set Ready
	2	DCD	Out	Data Carrier Detect
	3	DTR	In	Data Terminal Ready
	4	SG	-	Signal Ground, not chassis ground
	5	RD	Out	Receive Data
	6	TD	In	Transmit Data
	7	CTS	Out	Clear To Send
	8	RTS	In	Request To Send

Table 6. RS-232 connection

RS-485 Ports

When you configure a serial port to operate as an RS-485 interface, it supports both two-wire (half-duplex) and four-wire (full-duplex) modes. Configuration between two-wire and four-wire RS-485 modes is under software control. The pin-numbering of the RJ45 connector in RS-485 mode, when viewed from the front of the unit, is shown below.

Illustration	Pin no.	Signal		Direction	Description
		Four-wire mode	Two-wire mode		
	1				
	2	R-	-	In	Four wire: Receive
	3	T-	T-/R-	Out/In	Four-wire: Transmit Two-wire: Transmit/Receive
	4				
	5	R+		In	Four-wire: Receive
	6	T+	T+/R+	Out/In	Four-wire: Transmit Two-wire: Transmit/Receive
	7				
	8				

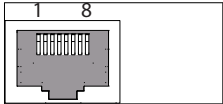
Table 7. RS-485 port pinout

4.5.3. Console Port

The router has a USB console port with a type C connector. The router acts as a device.

4.5.4. Antennas

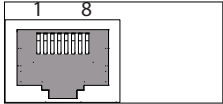
The router has three SMA connectors. They are:

- Two LTE antennas for the mobile radio - a MAIN and an AUXiliary
- Single antenna for GNSS/GPS

4.5.5. SFP Transceivers

This section applies only to products which support SFP transceivers.

Each SFP slot can hold one SFP transceiver. See "*Transceiver User Guide 6100-0000*" for transceiver handling instructions, which also can be downloaded from the product support pages at www.westermo.com/support/product-support.

In the event of contamination, the optical connectors in the SFP transceivers should only be cleaned by the use of forced nitrogen and some kind of cleaning stick. Recommended cleaning fluids are methyl-, ethyl-, isopropyl- or isobutyl alcohol, hexane or naphtha.



HANDLING OF SFP TRANSCEIVERS

SFP transceivers are supplied with plugs to avoid contamination inside the optical port. They are very sensitive to dust and dirt. If the fibre optic cable is disconnected from the product, a protective plug must be used on the transmitter/receiver. The protective plug must be kept on during transportation. The fibre optic cable must be handled the same way.

4.5.6. Reset Button

Use the reset button to request a system reset. When pressing the reset button, all LEDs turn on simultaneously. The length of time holding the reset button will determine its behaviour.

Press duration	PWR/CONFIG LED behaviour	Router behaviour on depress
0-3 seconds	Solid on	Normal reset to running config. No special LED activity.
3-15 seconds	Flashing fast	Releasing 3-15 seconds switches the router back to factory configuration. Note: this will wipe the configurations, both config1 and config2.
15-20 seconds	Solid on	Releasing 15-20 seconds performs a normal reset to running config.
20-30 seconds	Flashing slowly	Releasing 20-30 seconds reboots the router to recovery mode. Only to be done in case of emergency and under the guidance of Westermo support staff. Note: this may wipe the configurations, both config1 and config2.
> 30 seconds	Solid on	Releasing after 30 seconds performs a normal reset.

Table 8. Merlin series router reset behaviour

4.6. LED Indicators

The LED indicators described in this section are all single colour LEDs. When the router is powered on, the power LED is green.

The possible LED states are:

- Off
- Flashing slowly
- Flashing quickly
- On

LED	Status	Description
Booting up		The router takes less than a minute to boot up. During this time, the power LED flashes. Other LEDs display different diagnostic patterns during boot up. Booting is complete when the power LED stops flashing and stays on steady.
Power	On	Power is present
	Off	No power. Boot loader does not exist.
	Flashing	Booting
Config	On	The router is running a valid configuration file.
	Flashing slowly	The router is running in recovery mode (2.5 flashes/second)
	Flashing quickly	The router is running in factory configuration (5 flashes/second)
SIM	On	SIM selected and registered on the 3G/4G network
	Off	Not selected or SIM not inserted
	Flashing	SIM selected and not registered on the network
3G/LTE cellular signal strength LED	Both LEDs off	Data link not connected or signal strength ≤ -113 dBm
	Left LED on	Data link connected and signal strength ≤ -89 dBm
	Right LED off	
	Left LED off	Data link connected and signal strength is between -89 to -69 dBm
	Right LED on	
Both LEDs on	Data link connected and signal strength > -69 dBm	

Table 9. LED indicators

4.7. Ethernet Port LED Behaviour

There are four Ethernet ports and each has a pair of LEDs: a LINK LED (green) and a SPEED LED (amber). When looking at the port, the LED on the top is the LINK LED, and the SPEED LED is on the bottom.

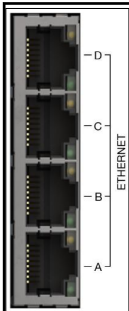

Figure 4. Merlin Ethernet ports

LINK LED (green)	On	Physical Ethernet link detected
	Off	No physical Ethernet link detected
	Flashing	Data is being transmitted or received over the link
SPEED LED (amber)	On	Link operating at 100 Mbps
	Off	Link operating at 10 Mbps

Table 10. Ethernet LED behaviour and descriptions

5. Factory Configuration Extraction From SIM Card

Merlin Series routers have a feature to update the factory configuration from a SIM card. This allows you to change the factory configuration of a router when installing the SIM.

1. Make sure the SIM card you are inserting has the required configuration written on it.
2. Ensure the router is powered off.
3. Insert the SIM card into SIM slot 1 following the instructions detailed in the Installation chapter.
4. Power up the router.

Depending on the model, the power LED and/or the configuration LED flash as usual.

The SIM LED starts flashing. This indicates the application responsible for LTE and configuration extraction management is running. It also means the update of the configuration is happening.

When the update is finished, depending on the model, the power LED and/or the configuration LED blink alternatively and very fast for 20 seconds.



NOTE

Factory configuration extraction is only supported on mobile modules that support phone book operations.

6. Accessing The Router

Access the router through the web interface or by using SSH. By default, Telnet is disabled.

Configuration Packages Used

Package	Sections
dropbear	dropbear
system	main
uhttpd	main cert

6.1. Accessing The Router Over Ethernet Using The Web Interface

DHCP is disabled by default, so if you do not receive an IP address via DHCP, assign a static IP to the PC that will be connected to the router.

PC IP address	192.168.100.100
Network mask	255.255.255.0
Default gateway	192.168.100.1

Assuming that the PC is connected to Port A on the router, in your internet browser, type in the default local IP address 192.168.100.1, and press **Enter**. The Authorization page appears.

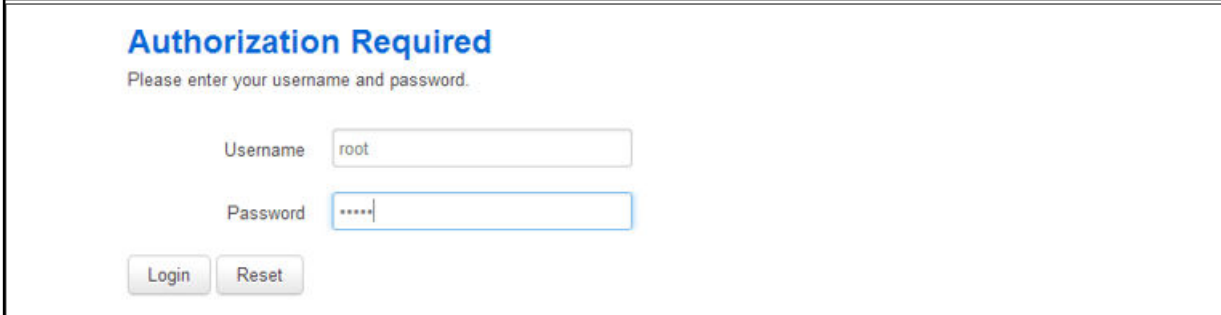

The login page

The password may vary depending on the factory configuration the router has been shipped with. The default settings are shown below. The username and password are case sensitive.

In the username field, type **root**. In the Password field, type **admin**.

Click **Login**. The Status page appears.

6.2. Accessing The Router Over Ethernet Using An SSH Client

You can also access the router over Ethernet, using Secure Shell (SSH) and optionally over Telnet.

To access CLI over Ethernet start an SSH client and connect to the router's management

IP address, on port **22**: **192.168.100.1/24**.

On the first connection, you may be asked to confirm that you trust the host.

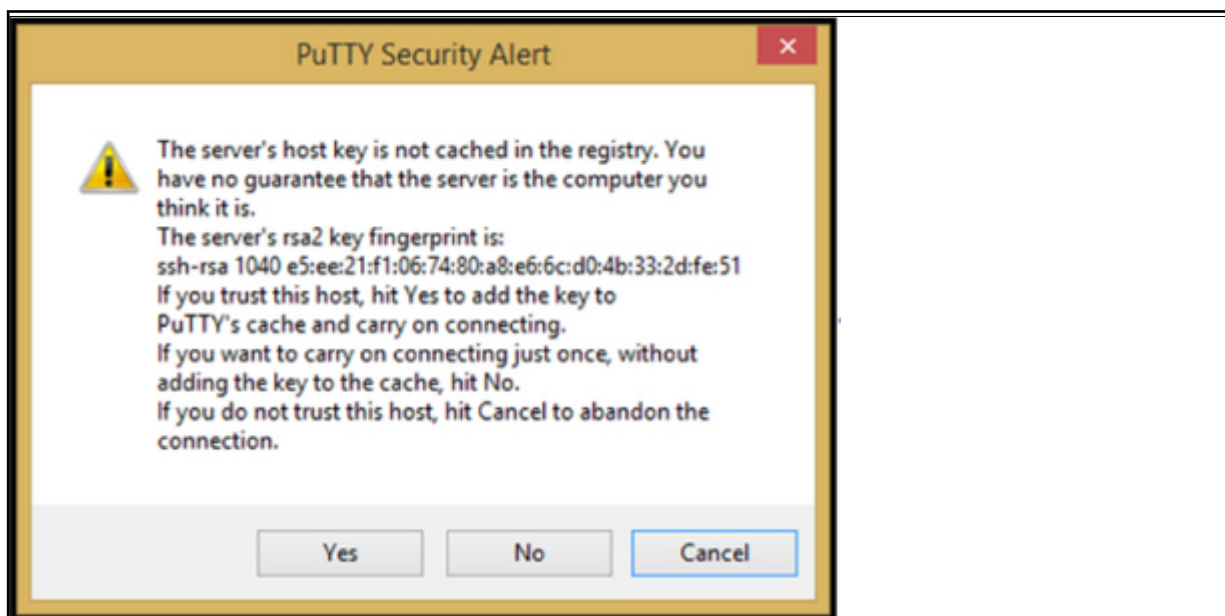

Confirming trust of the router's public key over SSH

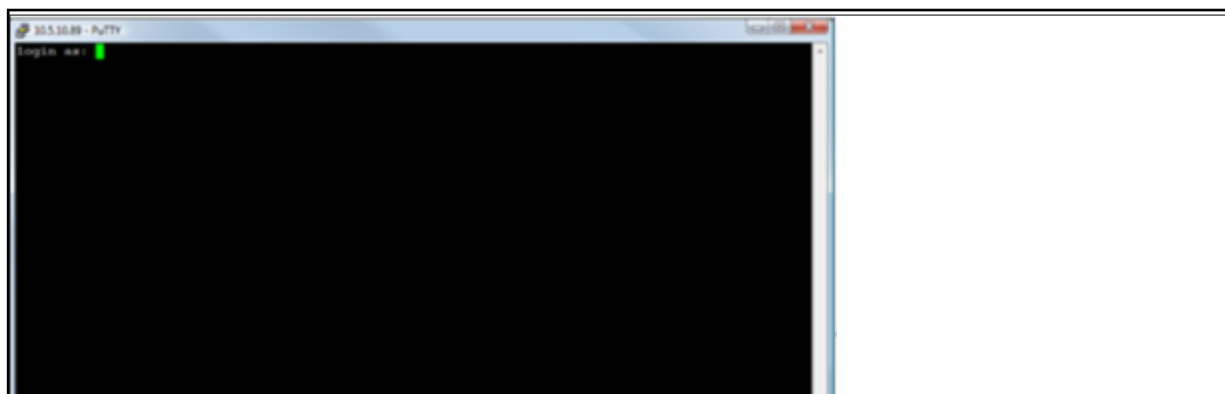

SSH CLI logon screen

In the SSH CLI logon screen, enter the default username and password.

Username: **root**

Password: **admin**

SCP (Secure Copy Protocol)

As part of accessing the router over SSH, you can also use SCP protocol. Use the same user authentication credentials as for SSH access. You can use SCP protocol to securely, manually transfer files from and to the router's SCP server.

No dedicated SPC client is supported; select the SCP client software of your own choice.

6.3. Accessing The Router Over Ethernet Using A Telnet Client

Telnet is disabled by default, when you enable Telnet, SSH is disabled.

To enable Telnet, enter:

```
root@VA_router: ~# /etc/init.d/dropbear disable
root@VA_router: ~# reboot
```

To re-enable SSH, enter:

```
root@VA_router: ~# /etc/init.d/dropbear enable
root@VA_router: ~# reboot
```



NOTE

As SSH is enabled by default, initial connection to the router to enable Telnet must be established over SSH.

6.4. Configuring The Password

Configuration packages used

Packages	Sections
system	main

To change your password, in the top menu click **System -> Administration**. The Administration page appears.

The router password section

In the Router Password section, type your new password in the password field and then retype the password in the confirmation field.

Scroll down the page and click **Save & Apply**.



NOTE

The username 'root' cannot be changed.

Web Field/UCI/Package Option	Description
Web: Password	Defines the root password. The password is displayed encrypted
UCI: system.main.password	via the CLI using the 'hashpassword' option.
Opt: password	UCI: system.main.hashpassword
	Opt: hashpassword

6.4.1. Configuring The Password Using UCI

The root password is displayed encrypted via the CLI using the hashpassword option.

```
root@VA_router:~# uci show system
system.main=system
system.main.hostname=VA_router
system.main.hashpassword=$1$jRX/x8A/$U5kLCMpi9dcahRhOl7eZV1
```

If you are changing the password using UCI, enter the new password in plain text using the password option.

```
root@VA_router:~# uci system.main.password=newpassword
root@VA_router:~# uci commit
```

The new password will take effect after a reboot and will now be displayed in encrypted format via the hashpassword option.

6.4.2. Configuring The Password Using Package Options

The root password is displayed encrypted via the CLI using the hashpassword option.

```
root@VA_router:~# uci export system
package system
config system 'main'
option hostname 'VA_router'
option hashpassword '$1$wRYYijOz$EeHN.GQcxXhRgNPVbqxVw
```

If you are changing the password using UCI, enter the new password in plain text using the password option.

```
package system
config system 'main'
option hostname 'VA_router'
option hashpassword '$1$wRYYijOz$EeHN.GQcxXhRgNPVbqxVw
option password 'newpassword'
```

The new password will take effect after reboot and will now be displayed in encrypted format via the hashpassword option.

6.5. Accessing The Device Using RADIUS Authentication

You can configure RADIUS authentication to access the router over SSH, web or local console interface.

```
package system
config system 'main'
option hostname 'VirtualAccess'
option timezone 'UTC'

config pam_auth
option enabled 'yes'
option pamservice 'login'
option pammodule 'auth'
option pamcontrol 'sufficient'
option type 'radius'
option servers '192.168.0.1:3333|test|20 192.168.2.5|secret|10'

config pam_auth
option enabled 'yes'
option pamservice 'sshd'
option pammodule 'auth'
option pamcontrol 'sufficient' ...it checks package management_users
option type 'radius'
option servers '192.168.0.1:3333|test|20 192.168.2.5|secret|10'

config 'pam_auth'
option enabled 'yes'
option pamservice 'luci'
option pammodule 'auth'
option pamcontrol 'sufficient'
option type 'radius'
servers '192.168.0.1:3333|test|20 192.168.2.5|secret|10'
```

UCI/Package Option	Description						
UCI: system.@pam_auth[0].enabled=yes Opt: enabled	Enables and disables RADIUS configuration sections. <table border="1"> <tr> <td>Yes:</td> <td>enables the following RADIUS configuration section</td> </tr> <tr> <td>No:</td> <td>disables the following RADIUS configuration section</td> </tr> </table>	Yes:	enables the following RADIUS configuration section	No:	disables the following RADIUS configuration section		
Yes:	enables the following RADIUS configuration section						
No:	disables the following RADIUS configuration section						
UCI: system.@pam_auth[0].pamservice Opt: pamservice	Selects the method which users should be authenticated by. <table border="1"> <tr> <td>login:</td> <td>User connecting over console cable</td> </tr> <tr> <td>ssh:</td> <td>User connecting over SSH</td> </tr> <tr> <td>luci:</td> <td>User connecting over web</td> </tr> </table>	login:	User connecting over console cable	ssh:	User connecting over SSH	luci:	User connecting over web
login:	User connecting over console cable						
ssh:	User connecting over SSH						
luci:	User connecting over web						
UCI: system.@pam_auth[0].pamcontrol Opt: pamcontrol	Specifies authentication behaviour after authentication fails or connection to RADIUS server is broken. <table border="1"> <tr> <td>Sufficient</td> <td>First authenticates against remote RADIUS if password authentication fails then it tries the local database (user defined in package management_users).</td> </tr> <tr> <td>Required:</td> <td>If either authentication fails of the RADIUS server is not reachable then the user is not allowed to access the router.</td> </tr> <tr> <td>[success=done new_authok_reqd=done authinfo_unavail=ignore default=die]:</td> <td>Local database is only checked if the RADIUS server is not reachable.</td> </tr> </table>	Sufficient	First authenticates against remote RADIUS if password authentication fails then it tries the local database (user defined in package management_users).	Required:	If either authentication fails of the RADIUS server is not reachable then the user is not allowed to access the router.	[success=done new_authok_reqd=done authinfo_unavail=ignore default=die]:	Local database is only checked if the RADIUS server is not reachable.
Sufficient	First authenticates against remote RADIUS if password authentication fails then it tries the local database (user defined in package management_users).						
Required:	If either authentication fails of the RADIUS server is not reachable then the user is not allowed to access the router.						
[success=done new_authok_reqd=done authinfo_unavail=ignore default=die]:	Local database is only checked if the RADIUS server is not reachable.						
UCI: system.@pam_auth[0].pammodule.auth Opt: pammodule	Enables user authentication.						
UCI: system.@pam_auth[0].type.radius Opt: type	Specifies the authentication method.						
UCI: system.@pam_auth[0].servers Opt: servers	Specifies the RADIUS server along with port number, password and timeout in seconds. Port and timeout are optional. The default port for RADIUS is 1812; default timeout is 10 seconds. Multiple servers are entered using a space separator. Syntax: <server ip address>[:<port>]<secret>[[timeout] Examples: option servers `192.168.0.1test` option servers `192.168.0.1 test 192.168.2.5:1234 secret 10`						
UCI: system.@pam_auth[1].args=service=ppp Opt: args	Additional arguments to pass to TACACS server.						

Information table for RADIUS authentication

6.6. Accessing The Device Using TACACS+ Authentication

You can configure TACACS+ authentication to access the router over SSH, web or local console interface.

```
package system
config system 'main'
option hostname 'VirtualAccess'
option timezone 'UTC'

config pam_auth
option enabled 'yes'
option pamservice 'sshd'
option pammodule 'auth'
option pamcontrol 'sufficient'
option type 'tacplus'
option servers '192.168.0.1:49|secret'

config pam_auth
option enabled 'yes'
option pamservice 'sshd'
option pammodule 'account'
option pamcontrol 'sufficient'
option type 'tacplus'
option servers '192.168.0.1:49|secret'

config 'pam_auth'
option enabled 'yes'
option pamservice 'sshd'
option pammodule 'session'
option pamcontrol 'sufficient'
option type 'tacplus'
servers '192.168.0.1:49|secret'
option args 'service=ppp'

config pam_auth
option enabled 'yes#'
option pamservice 'luci'
option pammodule 'auth'
option pammodule 'sufficient'
option type 'tacplus'
option servers '192.168.0.1:49|secret'
option args 'service=ppp'
```

```
config pam_auth
option enabled 'yes'
option pamservice 'luci'
option pammodule 'session'
option pamcontrol 'sufficient'
option type 'tacplus'
option servers '192.168.0.1:49|secret'
option args 'service=ppp'

config pam_auth
option enabled 'yes'
option pamservice 'login'
option pammodule 'account'
option pamcontrol 'sufficient'
option type 'tacplus'
option servers '192.168.0.1:49|secret'
option args 'service=ppp'

config pam_auth
option enabled 'yes'
option pamservice 'login'
option pammodule 'session'
option pamcontrol 'sufficient'
option type 'tacplus'
option servers '192.168.0.1:49|secret'
option args 'service=ppp'
```

UCI/Package Option	Description						
UCI: system.@pam_auth[0].enabled=yes Opt: enabled	Enables and disables TACACS configuration sections. <table border="1"> <tr> <td>Yes:</td> <td>enables the following TACACS configuration section</td> </tr> <tr> <td>No:</td> <td>disables the following TACACS configuration section</td> </tr> </table>	Yes:	enables the following TACACS configuration section	No:	disables the following TACACS configuration section		
Yes:	enables the following TACACS configuration section						
No:	disables the following TACACS configuration section						
UCI: system.@pam_auth[0].pamservice Opt: pamservice	Selects the method which users should be authenticated by. <table border="1"> <tr> <td>login:</td> <td>User connecting over console cable</td> </tr> <tr> <td>sshd:</td> <td>User connecting over SSH</td> </tr> <tr> <td>luci:</td> <td>User connecting over web</td> </tr> </table>	login:	User connecting over console cable	sshd:	User connecting over SSH	luci:	User connecting over web
login:	User connecting over console cable						
sshd:	User connecting over SSH						
luci:	User connecting over web						
UCI: system.@pam_auth[0].pamcontrol Opt: pamcontrol	Specifies authentication behaviour after authentication fails or connection to TACACS server is broken. <table border="1"> <tr> <td>Sufficient</td> <td>First authenticates against remote TACACS if password authentication fails then it tries the local database (user defined in package management_users).</td> </tr> <tr> <td>Required:</td> <td>If either authentication fails of the TACACS server is not reachable then the user is not allowed to access the router.</td> </tr> <tr> <td>[success=done new_authtok_reqd=done authinfo_unavail=ignore default=die:]</td> <td>Local database is only checked if the TACACS server is not reachable.</td> </tr> </table>	Sufficient	First authenticates against remote TACACS if password authentication fails then it tries the local database (user defined in package management_users).	Required:	If either authentication fails of the TACACS server is not reachable then the user is not allowed to access the router.	[success=done new_authtok_reqd=done authinfo_unavail=ignore default=die:]	Local database is only checked if the TACACS server is not reachable.
Sufficient	First authenticates against remote TACACS if password authentication fails then it tries the local database (user defined in package management_users).						
Required:	If either authentication fails of the TACACS server is not reachable then the user is not allowed to access the router.						
[success=done new_authtok_reqd=done authinfo_unavail=ignore default=die:]	Local database is only checked if the TACACS server is not reachable.						
UCI: system.@pam_auth[0].pammodule.auth Opt: pammodule	Enables user authentication.						
UCI: system.@pam_auth[0].type.radius Opt: type	Specifies the authentication method.						
UCI: system.@pam_auth[0].servers Opt: servers	Specifies the TACACS server along with port number, password and timeout in seconds. Port and timeout are optional. The default port for TACACS is 49. Multiple servers are entered using a space separator. Syntax: <server ip address>[:<port>]<secret> Examples: option servers `192.168.0.1test` option servers `192.168.0.1 test 192.168.2.5:1234 secret 10`						
UCI: system.@pam_auth[1].args=service=ppp Opt: args	Additional arguments to pass to TACACS server.						

6.7. SSH

SSH allows you to access remote machines over text-based shell sessions. SSH uses public key cryptography to create a secure connection. These connections allow you to issue commands remotely via a command line.

The router uses a package called Dropbear to configure the SSH server on the box. You can configure Dropbear using the web interface or through an SSH connection by editing the file stored on: /etc/config_name/dropbear.

Configuration packages used

Package	Sections
dropbear	dropbear

SSH access using the web interface

In the top menu, click **System -> Administration**. The Administration page appears.

Scroll down to the SSH Access section.

SSH Access

Dropbear offers [SSH](#) network shell access and an integrated [SCP](#) server

Dropbear Instance

Interface LAN: (no interfaces attached)
 LAN1: 
 MOBILE1: 
 PPPoADSL: 
 loopback: 
 unspecified
Listen only on the given interface or, if unspecified, on all

Port Specifies the listening port of this Dropbear instance

Password authentication Allow SSH password authentication

Allow root logins with password Allow the root user to login with password

Gateway ports Allow remote hosts to connect to local SSH forwarded ports

Idle Session Timeout (seconds) Remote session will be closed after this many seconds of inactivity

Maximum login attempts SSH connection is dropped once this limit is reached

The SSH access section

Web Field/UCI/Package Options	Description				
Web: Interface UCI: dropbear:@dropbear[0].Interface Opt: Interface	Listens only on the selected interface. If you check unspecified, it listens on all interfaces. All configured interfaces will be displayed via the web GUI. <table border="1"> <tr> <td>(unspecified)</td> <td>Listend on all interfaces.</td> </tr> <tr> <td>Range</td> <td>Configured interface names.</td> </tr> </table>	(unspecified)	Listend on all interfaces.	Range	Configured interface names.
(unspecified)	Listend on all interfaces.				
Range	Configured interface names.				
Web: Port UCI: dropbear:@dropbear[0].Port Opt: port	Specifies the listening port of the Dropbear instance. <table border="1"> <tr> <td>22</td> <td>Disabled</td> </tr> <tr> <td>Range</td> <td>0-65535</td> </tr> </table>	22	Disabled	Range	0-65535
22	Disabled				
Range	0-65535				
Web: Password authentication UCI: dropbear:@dropbear[0].PasswordAuth Opt: PasswordAuth	If enabled, allows SSH password authentication. <table border="1"> <tr> <td>0</td> <td>Disabled</td> </tr> <tr> <td>1</td> <td>Enabled</td> </tr> </table>	0	Disabled	1	Enabled
0	Disabled				
1	Enabled				
Web: Allow root logins with password UCI: dropbear:@dropbear[0].RootPasswordAuth Opt: RootPasswordAuth	Allows the root user to login with password. <table border="1"> <tr> <td>0</td> <td>Disabled</td> </tr> <tr> <td>1</td> <td>Enabled</td> </tr> </table>	0	Disabled	1	Enabled
0	Disabled				
1	Enabled				
Web: Gateway ports UCI: dropbear:@dropbear[0].GatewayPorts Opt: GatewayPorts	Allows remote hosts to connect to local SSH forwarded ports. <table border="1"> <tr> <td>0</td> <td>Disabled</td> </tr> <tr> <td>1</td> <td>Enabled</td> </tr> </table>	0	Disabled	1	Enabled
0	Disabled				
1	Enabled				
Web: Idle Session Timeout UCI: dropbear:@dropbear[0].IdleTimeout Opt: IdleTimeout	Defines the idle period where the remote session will be closed after the allocated number of seconds of inactivity. <table border="1"> <tr> <td>30</td> <td>30 seconds.</td> </tr> <tr> <td>Range</td> <td></td> </tr> </table>	30	30 seconds.	Range	
30	30 seconds.				
Range					
Web: n/a UCI: dropbear:@dropbear[0].BannerFile Opt: BannerFile	Defines a banner file to be displayed during login. <table border="1"> <tr> <td>/etc/banner</td> <td></td> </tr> <tr> <td>Range</td> <td></td> </tr> </table>	/etc/banner		Range	
/etc/banner					
Range					
Web: Maximum login attempts UCI: dropbear:@dropbear[0].MaxLoginAttempts Opt: MaxLoginAttempts	Specifies maximum login failures before session terminates. <table border="1"> <tr> <td>10</td> <td></td> </tr> <tr> <td>0-infinite</td> <td></td> </tr> </table>	10		0-infinite	
10					
0-infinite					

6.8. Package Dropbear Using UCI

```
root@VA_router:~# uci show dropbear
dropbear.@dropbear[0]=dropbear
dropbear.@dropbear[0].PasswordAuth=on
dropbear.@dropbear[0].RootPasswordAuth=on
dropbear.@dropbear[0].GatewayPorts=0
dropbear.@dropbear[0].IdleTimeout=30
dropbear.@dropbear[0].Port=22
dropbear.@dropbear[0].MaxLoginAttempts=3

Package dropbear using package options
root@VA_router:~# uci export dropbear
package dropbear
config dropbear'
option PasswordAuth 'on'
option RootPasswordAuth 'on'
option Port '22'
option GatewayPorts '0'
option IdleTimeout '30'
option MaxLoginAttempts '3'
```

6.9. Certs And Private Keys

Certificates are used to prove ownership of a public key. They contain information about the key, its owner's ID, and the digital signature of an individual that has verified the content of the certificate.

In asymmetric cryptography, public keys are announced to the public, and a different private key is kept by the receiver. The public key is used to encrypt the message and the private key is used to decrypt it.

To access certs and private keys, in the top menu, click **System -> Administration**. The Administration page appears. Scroll down to the Certs & Private Keys section.

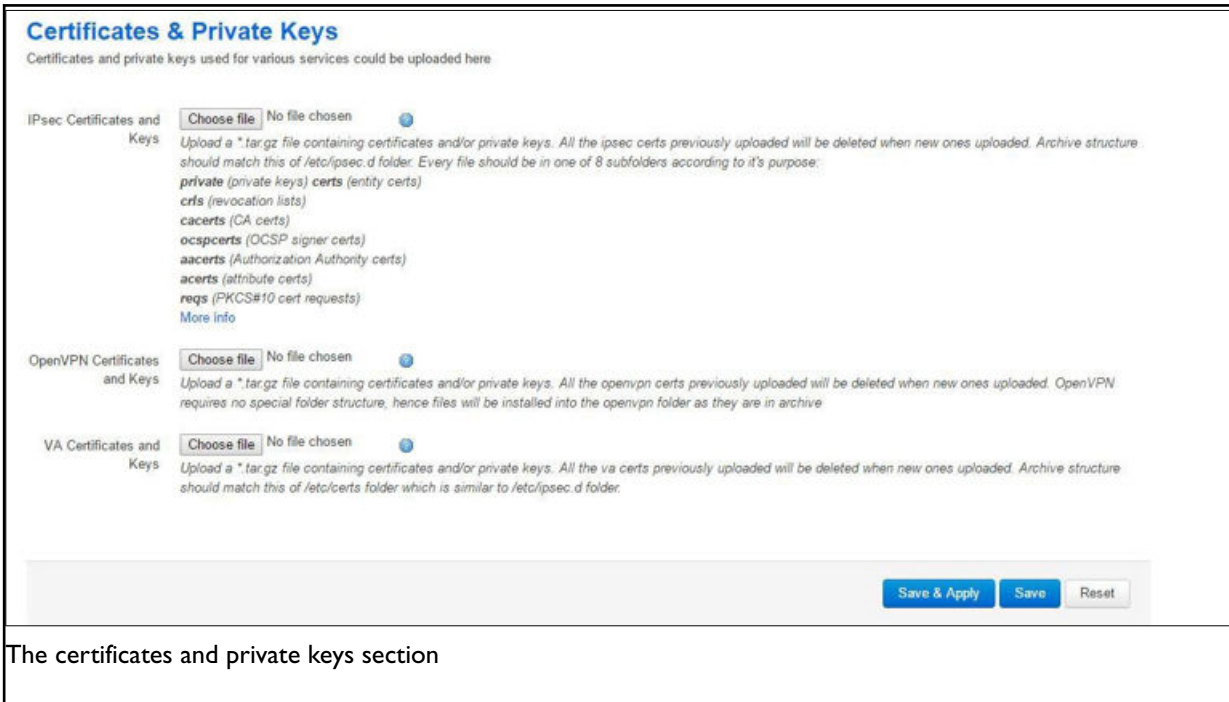

The certificates and private keys section

This section allows you to upload any certificates and keys that you may have stored. There is support for IPsec, OpenVPN and VA certificates and keys.

If you have generated your own SSH public keys, you can input them in the SSH Keys section, for SSH public key authentication.



The SSH-keys box

6.10. Configuring A Router's Web Server

The router's web server is configured in package uhttpd. This file defines the behaviour of the server and default values for certificates generated for SSL operation. uhttpd supports multiple instances, that is, multiple listen ports, each with its own document root and other features, as well as cgi and lua. There are two sections defined:

Main: this uHTTPd section contains general server settings.

Cert: this section defines the default values for SSL certificates.

Configuration Packages Used

Package	Sections
uhttpd	main
	cert

To configure the router's HTTPS server parameters, in the top menu, select **Services -> HTTP Server**. The HTTP Server page has two sections:

Main Settings	Server Configurations
Certificate Settings	SSL certifications

6.10.1. Main Settings

HTTP Server

Configuration of the Http Server used for management of the device.

Main Settings

Basic configuration of the Http Server.

Listen Address and Port:
Specifies the ports and addresses to listen on for plain HTTP access. If only a port number is given, the server will attempt to serve both IPv4 and IPv6 requests. Use 0.0.0.0:80 to bind at port 80 only on IPv4 interfaces or [::]80 to serve only IPv6

Secure Listen Address and Port:
Specifies the ports and addresses to listen on for encrypted HTTPS access.

Home path:
Defines the server document root.

Cert file:
PEM certificate used to serve HTTPS connections.

Key file:
PEM private key used to serve HTTPS connections.

CGI prefix:
Defines the prefix for CGI scripts, relative to the document root. CGI support is disabled if this option is missing

Script timeout (s):
Maximum wait time for CGI or Lua requests in seconds. Requested executables are terminated if no output was generated until the timeout expired

Network timeout (s):
Maximum wait time for network activity. Requested executables are terminated and connection is shut down if no network activity occurred for the specified number of seconds

rfc1918 filter:

TLS protocol version:
Min supported TLS version. versions below this will not be supported by the https server

HTTP server main settings

Web Field/UCI/Package Option	Description						
Web: Listen Address and Port UCI: uhttpd.main.listen_http Opt: list listen_http	Specifies the ports and addresses to listen on for plain HTTP access. If only a port number is given, the server will attempt to serve both IPv4 and IPv6 requests. <table border="1" style="margin-top: 10px;"> <tr> <td>0.0.0.0:80</td> <td>Bind at port 80 only on IPv4 interfaces.</td> </tr> <tr> <td>[::]:80</td> <td>Bind at port 80 only on IPv6 interfaces.</td> </tr> <tr> <td>Range</td> <td>IP address and/or port</td> </tr> </table>	0.0.0.0:80	Bind at port 80 only on IPv4 interfaces.	[::]:80	Bind at port 80 only on IPv6 interfaces.	Range	IP address and/or port
0.0.0.0:80	Bind at port 80 only on IPv4 interfaces.						
[::]:80	Bind at port 80 only on IPv6 interfaces.						
Range	IP address and/or port						
Web: Secure Listen Address and Port UCI: uhttpd.main.listen_https Opt: list listen_https	Specifies the ports and address to listen on for encrypted HTTPS access. The format is the same as listen_http. <table border="1" style="margin-top: 10px;"> <tr> <td>0.0.0.0:443</td> <td>Bind at port 443 only.</td> </tr> <tr> <td>[::]:443</td> <td></td> </tr> <tr> <td>Range</td> <td>IP address and/or port.</td> </tr> </table>	0.0.0.0:443	Bind at port 443 only.	[::]:443		Range	IP address and/or port.
0.0.0.0:443	Bind at port 443 only.						
[::]:443							
Range	IP address and/or port.						
Web: Home path UCI: uhttpd.main.home Opt: home	Defines the server document root <table border="1" style="margin-top: 10px;"> <tr> <td>/www</td> <td></td> </tr> <tr> <td>Range</td> <td></td> </tr> </table>	/www		Range			
/www							
Range							

<p>Web: Cert file</p> <p>UCI: uhttpd.main.cert Opt: cert</p>	<p>ASN.1/DER certificate used to serve HTTPS connections. If no listen_https options are given the key options are ignored.</p> <table border="1" data-bbox="699 282 852 353"> <tr><td>/etc/uhttpd.crt</td><td></td></tr> <tr><td>Range</td><td></td></tr> </table>	/etc/uhttpd.crt		Range			
/etc/uhttpd.crt							
Range							
<p>Web: Key file</p> <p>UCI: uhttpd.main.key Opt: key</p>	<p>ASN.1/DER private key used to serve HTTPS connections. If no listen_https options are given the key options are ignored.</p> <table border="1" data-bbox="699 450 852 521"> <tr><td>/etc/uhttpd.key</td><td></td></tr> <tr><td>Range</td><td></td></tr> </table>	/etc/uhttpd.key		Range			
/etc/uhttpd.key							
Range							
<p>Web: CGI profile</p> <p>UCI: uhttpd.main.cgi_prefix</p> <p>Opt: cgi_prefix</p>	<p>Defines the prefix for CGI scripts, relative to the document root. CGI support is disabled if this option is missing.</p> <table border="1" data-bbox="699 618 799 689"> <tr><td>/cgi-bin</td><td></td></tr> <tr><td>Range</td><td></td></tr> </table>	/cgi-bin		Range			
/cgi-bin							
Range							
<p>Web: N/A</p> <p>UCI: uhttpd.main.lua_prefix</p> <p>Opt: lua_prefix</p>	<p>Defines the prefix for dispatching requests to the embedded lua interpreter, relative to the document root. Lua support is disabled if this option is missing.</p> <table border="1" data-bbox="699 786 791 857"> <tr><td>/luci</td><td></td></tr> <tr><td>Range</td><td></td></tr> </table>	/luci		Range			
/luci							
Range							
<p>Web: N/A</p> <p>UCI: uhttpd.main.lua_handler</p> <p>Opt: lua_handler</p>	<p>Specifies the lua handler script used to initialise the lua runtime on server start.</p> <table border="1" data-bbox="699 954 956 1025"> <tr><td>/usr/lib/luasyscall/sgl/uhttpd.lua</td><td></td></tr> <tr><td>Range</td><td></td></tr> </table>	/usr/lib/luasyscall/sgl/uhttpd.lua		Range			
/usr/lib/luasyscall/sgl/uhttpd.lua							
Range							
<p>Web: Script timeout</p> <p>UCI: uhttpd.main.script_timeout</p> <p>Opt: script_timeout</p>	<p>Sets the maximum wait time for CGI or lua requests in seconds.</p> <p>Requested executables are terminated if no output was generated.</p> <table border="1" data-bbox="699 1133 791 1205"> <tr><td>60</td><td></td></tr> <tr><td>Range</td><td></td></tr> </table>	60		Range			
60							
Range							
<p>Web: Network timeout</p> <p>UCI: uhttpd.main.network_timeout Opt: network_timeout</p>	<p>Maximum wait time for network activity. Requested executables are terminated and the connection is shut down if no network activity occurred for the specified number of seconds.</p> <table border="1" data-bbox="699 1326 791 1397"> <tr><td>30</td><td></td></tr> <tr><td>Range</td><td></td></tr> </table>	30		Range			
30							
Range							
<p>Web: rfc 1918 filter</p> <p>UCI: uhttpd.main.rfc1918_filter</p> <p>Opt: rfc1918_filter</p>	<p>Enables option to reject requests from RFC1918 IPs to public server IPs (DNS rebinding counter measure).</p> <table border="1" data-bbox="699 1494 820 1565"> <tr><td>0</td><td>Disabled</td></tr> <tr><td>1</td><td>Enabled</td></tr> </table>	0	Disabled	1	Enabled		
0	Disabled						
1	Enabled						
<p>Web: TLS protocol version UCI: uhttpd.main.tls_version Opt: tls_version</p>	<p>Defines the minimum supported TLS version for the https server.</p> <table border="1" data-bbox="699 1626 767 1697"> <tr><td>1.0</td><td></td></tr> <tr><td>1.1</td><td></td></tr> <tr><td>1.2</td><td></td></tr> </table>	1.0		1.1		1.2	
1.0							
1.1							
1.2							
<p>Web: N/A</p> <p>UCI: uhttpd.main.realm Opt: realm</p>	<p>Defines basic authentication realm when prompting the client for credentials (HTTP 400).</p> <table border="1" data-bbox="699 1830 833 1865"> <tr><td>OpdenWrt</td><td></td></tr> <tr><td>Range</td><td></td></tr> </table>	OpdenWrt		Range			
OpdenWrt							
Range							

Web: N/A UCI: uhttpd.main.config Opt: config	Config file in Busybox httpd format for additional settings. Currently only used to specify basic auth areas. <table border="1"> <tr> <td>/etc/http.conf</td> <td></td> </tr> <tr> <td>Range</td> <td></td> </tr> </table>	/etc/http.conf		Range	
/etc/http.conf					
Range					
Web: N/A UCI: uhttpd.main.index_page Opt: index_page	Index file to use for directories, for example, add index.php when using php.				
Web: N/A UCI: httpd.main.error_page Opt: error_page	Virtual URL of file of CGI script to handle 404 requests. Must begin with '/' (forward slash).				
Web: N/A UCI: uhttpd.main.no_symlinks Opt: no_symlinks	Does not follow symbolic links if enabled. <table border="1"> <tr> <td>0</td> <td>Disabled</td> </tr> <tr> <td>1</td> <td>Enabled</td> </tr> </table>	0	Disabled	1	Enabled
0	Disabled				
1	Enabled				
Web: N/A UCI: uhttpd.main.no_dirlists Opt: no_symlinks	Does not generate directory listings if enabled. <table border="1"> <tr> <td>0</td> <td>Disabled</td> </tr> <tr> <td>1</td> <td>Enabled</td> </tr> </table>	0	Disabled	1	Enabled
0	Disabled				
1	Enabled				

HTTP Server Using Command Line

Multiple sections of the type uhttpd may exist. The init script will launch one webserver instance per section.

A standard uhttpd configuration is shown below.

HTTPs Server Certificate Settings

To configure HTTPs server certificate settings, in the top menu, select **Services -> HTTP Server**. Scroll down to the Certificate Settings section.

Certificate Settings
Set parameters for initial certificate generation.

[Delete](#)

Days: Validity time of the generated certificates in days.

Bits: Size of the generated RSA key in bits.

country: ISO country code of the certificate issuer.

state: State of the certificate issuer.

location: Location/city of the certificate issuer.

commonname: Common name covered by the certificate.

[Save & Apply](#)
[Save](#)
[Reset](#)

HTTP server certificate settings

Web Field/UCI/Package Option	Description				
Web: Days UCI: uhttpd.px5g.days Opt: days	Validity time of the generated certificates in days. <table border="1"> <tr> <td>730</td> <td></td> </tr> <tr> <td>Range</td> <td></td> </tr> </table>	730		Range	
730					
Range					
Web: Bits UCI: uhttpd.px5g.bits Opt: bits	Size of the generated RSA key in bits. <table border="1"> <tr> <td>1024</td> <td></td> </tr> <tr> <td>Range</td> <td></td> </tr> </table>	1024		Range	
1024					
Range					
Web: Country UCI: uhttpd.px5g.country Opt: country	ISO code of the certificate issuer.				
Web: State UCI: uhttpd.px5g.state Opt: state	State of the certificate issuer.				
Web: Location UCI: uhttpd.px5g.location Opt: location	Location or city of the certificate user.				
Web: Commonname UCI: uhttpd.commonname Opt: commonname	Common name covered by the certificate. For the purposes of secure activation, this must be set to the serial number (Eth0 MAC address) of the device.				

HTTP Server Using UCI

```

root@VA_router:~# uci show uhttpd
uhttpd.main=uhttpd
uhttpd.main.listen_http=0.0.0.0:80
uhttpd.main.listen_https=0.0.0.0:443
uhttpd.main.home=/www uhttpd.main.rfc1918_filter=1
uhttpd.main.cert=/etc/uhttpd.crt
uhttpd.main.key=/etc/uhttpd.key
uhttpd.main.cgi_prefix=/cgi-bin
uhttpd.main.script_timeout=60
uhttpd.main.network_timeout=30
uhttpd.main.config=/etc/http.conf
uhttpd.main.tls_version=1.0

```

HTTP Server using Package Options

```
root@VA_router:~# uci export uhttpd
config uhttpd 'main'
list listen_http '0.0.0.0:80'
list listen_https '0.0.0.0:443'
option home '/www'
option rfc1918_filter '1'
option cert '/etc/uhttpd.crt'
option key '/etc/uhttpd.key'
option cgi_prefix '/cgi-bin'
option script_timeout '60'
option network_timeout '30'
option config '/etc/http.conf'
option tls_version '1.0'
```

6.11. Basic Authentication (Httpd Conf)

For backward compatibility reasons, uhttpd uses the file `/etc/httpd.conf` to define authentication areas and the associated usernames and passwords. This configuration file is not in UCI format.

Authentication realms are defined in the format `prefix:username:password` with one entry and a line break.

Prefix is the URL part covered by the realm, for example, `cgi-bin` to request basic auth for any CGI program.

Username specifies the username a client has to login with.

Password defines the secret password required to authenticate.

The password can be either in plain text format, MD5 encoded or in the form `puser` where the user refers to an account in `/etc/shadow` or `/etc/passwd`.

If you use `p...` format, uhttpd will compare the client provided password against the one stored in the shadow or passwd database.

6.12. Securing Uhttpd

By default, uhttpd binds to 0.0.0.0 which also includes the WAN port of your router. To bind uhttpd to the LAN port only you have to change the `listen_http` and `listen_https` options to your LAN IP address.

To get your current LAN IP address, enter:

```
uci get network.lan.ipaddr
```

Then modify the configuration appropriately:

```
uci set uhttpd.main.listen_http='192.168.1.1:80'
uci set uhttpd.main.listen_https='192.168.1.1:443'

config 'uhttpd' 'main'
list listen_http 192.168.1.1:80
list listen_https 192.168.1.1:443
```

6.13. Displaying Custom Information Via Login Screen

The login screen, by default, shows the hostname of the router in addition to the username and password prompt. However, the router can be configured to show some other basic information if required using a UDS script.

Note: this can only be configured via the command line.

Configuration Packages Used

Package	Sections
luci	main
uds	script

Configuring Login Screen Customer Information

The luci package option `login_page_info_template` is configured with the path to a UDS script that would render the required information on the right side of the login page.

The following example shows how to display serial number and mobile signal strength.



NOTE

This can only be configured via the command line.

VA_router

Authorization Required

Please enter your username and password.

Username

Password

Serial: 00E0C8118878

Signal strength: -113 dBm

Example login screen displaying serial and signal strength

Login Screen Customer Information using UCI

```
root@VA_router:~# uci show luci
luci.main=core
luci.main.login_page_info_template=/tmp/uds/sysauth_template
root@VA_router:~# uci show uds
uds.sysauth_template=script
uds.sysauth_template.enabled=1
uds.sysauth_template.exec_type=none
uds.sysauth_template.fname=sysauth_template.htm
uds.sysauth_template.type=none
uds.sysauth_template.text=Serial: <=pcdata(luci.version.serial)%><br><% local sig =luci.dispatcher.uci.cursor_state():get("mobile",
"3g_1_1",
"sig_dbm") or -113 sig = tonumber(sig) local hue = (sig + 113) * 2 local hue = math.min(math.max(hue, 0), 120) > Signal strength:
<h3 style="color:hsl(<%=hue%>, 90%, 50%);display:inline;"><%=sig%</h>dBm
```

7. Router File Structure

This section describes the file structure and location of essential directories and files on the router.

Throughout this document, we use information tables to show the different ways to configure the router using the router's web interface and command line interface (CLI).

When showing examples of the command line interface we use the host name 'VA_router' to indicate the system prompt. For example, the table below displays what the user should see when entering the command to show the current configuration in use on the router:

```
root@VA_router:~# va_config.sh
```

7.1. System Information

General information about software and configuration used by the router is displayed on the Status page. To view the running configuration file status on the web interface, in the top menu, select **Status -> Overview**. This page also appears immediately after you have logged in.



The screenshot shows the 'Status' page of a router's web interface. The page has a dark navigation bar at the top with links for 'Status', 'System', 'Services', 'Network', and 'Logout'. Below the navigation bar, the 'Status' section is titled in blue. Underneath, there is a 'System' section with a table of system information.

System	
Router Name	GW0000
Router Model	Virtual Access GW000109AAD179E
Firmware Version	VIE-16.00.55
Current Image/Config	image2 / config2
Kernel Version	3.2.12
Local Time	Fri Aug 5 11:43:52 2016
Uptime	0h 10m 8s
Load Average	0.27, 0.35, 0.31

Example of the status page

System information is also available from the CLI if you enter the following command:

```
root@VA_router:~# va_vars.sh
```

The example below shows the output from the above command.

```
VA_SERIAL: 00E0C8121215
VA_MODEL: GW0000
VA_ACTIVEIMAGE: image2
VA_ACTIVECONFIG: config1
VA_IMAGE1VER: VIE-16.00.44
VA_IMAGE2VER: VIE-16.00.44
```

7.2. Identify Your Software Version

To check which software version your router is running, in the top menu, browse to: **Status -> Overview**.

Status	
System	
Router Name	GW0000
Router Model	Virtual Access GW00319AAAD179E
Firmware Version	VIE-16.00.55
Current Image/Config	image2 / config2
Kernel Version	3.2.12
Local Time	Fri Aug 5 11:43:52 2016
Uptime	0h 10m 8s
Load Average	0.27, 0.35, 0.31

The status page showing a software version prior to 72.002

Status	
System	
Router Name	dmrpn
Router Model	GW2028
Firmware Version	LIS-15.00.72.002rc4
Current Image/Config	image1 / config1
Kernel Version	3.2.12
Local Time	Thu Jan 26 14:46:03 2017
Uptime	0h 39m 37s
Load Average	1.02, 0.53, 0.48

The status page showing software version 72.002

In the Firmware Version row, the first two digits of the firmware version identify the hardware platform, for example LIS-15; while the remaining digits: .00.72.002, show the software version.

7.3. Image Files

The system allows for two firmware image files:

- image1, and
- image2

Two firmware images are supported to enable the system to rollback to a previous firmware version if the upgrade of one image fails.

The image names (image1, image2) themselves are symbols that point to different partitions in the overall file system. A special image name “altimage” exists which always points to the image that is not running.

The firmware upgrade system always downloads firmware to “altimage”.

7.4. Directory Locations For UCI Configuration Files

Router configurations files are stored in folders on:

- /etc/factconf,
- /etc/config1, and
- /etc/config2

Multiple configuration files exist in each folder. Each configuration file contains configuration parameters for different areas of functionality in the system.

A symbolic link exists at `/etc/config`, which always points to one of `factconf`, `config1` or `config2` is the active configuration file.

Files that appear to be in `/etc/config` are actually in `/etc/factconf|config1|config2` depending on which configuration is active.

If `/etc/config` is missing on start-up, for example on first boot, the links and directories are created with configuration files copied from `/rom/etc/config/`.

At any given time, only one of the configurations is the active configuration. The UCI system tool (Unified Configuration Interface) only acts upon the currently active configuration.

7.5. Viewing And Changing Current Configuration

To show the configuration currently running, enter:

```
root@VA_router:~# va_config.sh
```

To show the configuration to run after the next reboot, enter:

```
root@VA_router:~# va_config.sh next
```

To set the configuration to run after the next reboot, enter:

```
root@VA_router:~# va_config.sh -s [factconf|config1|config2|altconfig]
```

7.6. Configuration File Syntax

The configuration files consist of sections – or packages - that contain one or more config statements. These optional statements define actual values.

Below is an example of a simple configuration file.

```
package 'example'  
config 'example' 'test'  
option 'string' 'some value'  
option 'boolean' '1'  
list 'collection' 'first item'  
list 'collection' 'second item'
```

The config `'example' 'test'` statement defines the start of a section with the type `example` and the name `test`.

Command	Target	Description
export	[<config>]	Exports the configuration in a machine readable format. It is used internally to evaluate configuration files as shell scripts.
import	[<config>]	Imports configuration files in UCI syntax.
add	<config> <section-type>	Adds an anonymous section of type-section type to the given configuration.
add_list	<config>.<section>.<option>=<string>	Adds the given string to an existing list option.
show	[<config>[.<section>[.<option>]]]	Shows the given option, section or configuration in compressed notation.
get	<config>.<section>[.<option>]	Gets the value of the given option or the type of the given section.
Set	<config>.<section>[.<option>]=<value>	Sets the value of the given option, or adds a new section with the type set to the given value.
delete	<config>[.<section>[.<option>]]	Deletes the given section or option.

Managing Sets of Configuration Files using Directory Manipulation

Configurations can also be managed using directory manipulation. To remove the contents of the current folder, enter:

```
root@VA_router:/etc/config1# rm -f *
```



WARNING

The above command makes irreversible changes

To remove the contents of a specific folder regardless of the current folder (config2), enter:

```
root@VA_router:/ # rm -f /etc/config1/*
```



WARNING

The above command makes irreversible changes

To copy the contents of one folder into another (config2 into config1), enter:

```
root@VA_router:/etc/config1# cp /etc/config2/* /etc/config1
```

7.7. Exporting A Configuration File

If you have software versions prior to 72.002, go to 'Exporting a configuration file using the web interface for software versions prior to 72.002'

If you have software version 72.002 or above, go to 'Exporting a configuration file using the web interface for software versions 72.002 and above.'

To export a configuration file using UCI, for any software version, go to 'Exporting a configuration file using UCI.'

7.7.1. Exporting A Configuration File Using The Web Interface For Software Versions Pre- 72.002

The current running configuration file may be exported using the web interface.

In the top menu, select **System -> Backup/Flash Firmware**. The Flash operations page appears.

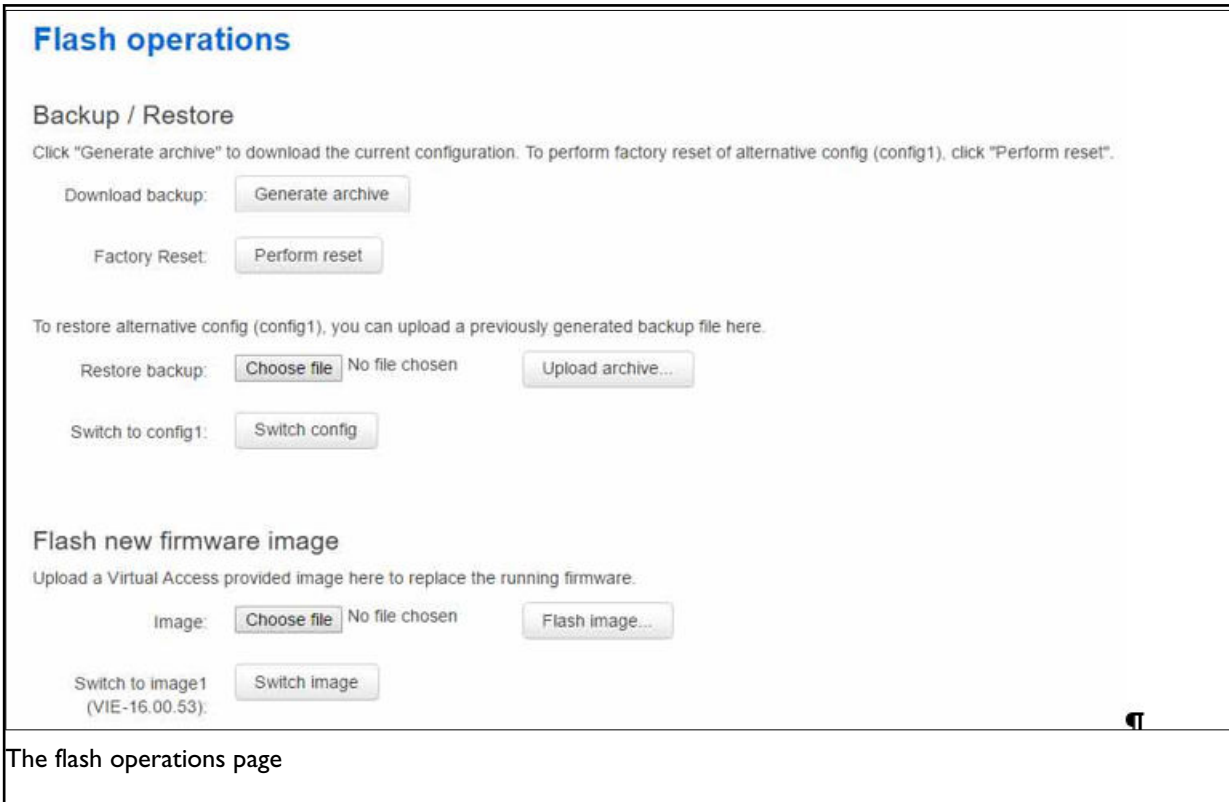

The flash operations page

In the Backup/Restore section, select **Generate Archive**.

7.7.2. Exporting A Configuration File Using The Web Interface For Software Version 72.002 And Above

The current running configuration file may be exported using the web interface.

In the top menu, select **System -> Flash Operations**. The Flash operations page appears.

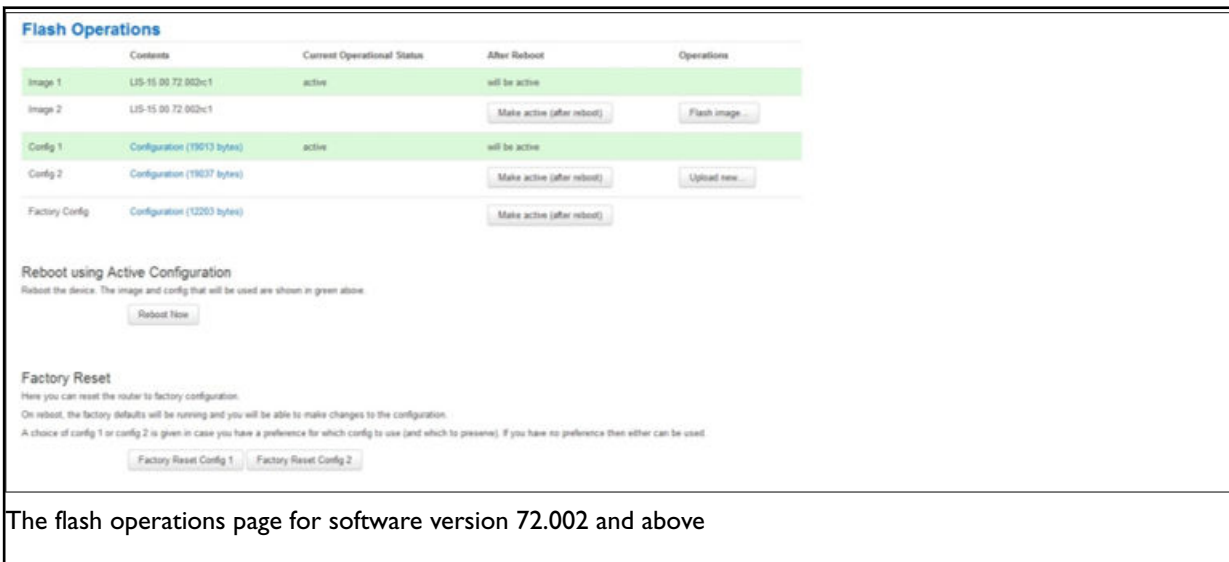

The flash operations page for software version 72.002 and above

In the **Flash Operation** section, click the configuration file in the Contents column to download it.

7.7.3. Exporting A Configuration File Using UCI

You can view any configuration file segment using UCI. To export the running configuration file, enter:

```
root@VA_router:~# uci export
```

To export the factory configuration file, enter:

```
root@VA_router:~# uci -c /etc/factconf/ export
```

To export config1 or config2 configuration file, enter:

```
root@VA_router:~# uci -c /etc/config1/ export
```

```
root@VA_router:~# uci -c /etc/config2/ export
```

7.8. Importing A Configuration File

If you have software versions prior to 72.002, go to section 'Importing a configuration file using the web interface for software versions pre-72.002

If you have software version 72.002 or above, go to section 'Importing a configuration file using the web interface for software version 72.002 and above.

To import a configuration file using UCI, for any software version, go to section 'Importing a configuration file using UCI.

7.8.1. Importing A Configuration File Using The Web Interface For Software Versions Pre- 72.002

You can import a configuration file to the alternate configuration segment using the web interface. This will automatically reboot the router into this configuration file.

In the top menu, select **System -> Backup/Flash Firmware**. The Flash operations page appears.

The flash operations page

Under Backup/Restore, choose **Restore Backup: Choose file**. Select the appropriate file and then click **Upload archive**.



When the 'waiting for router' icon disappears, the upgrade is complete, and the login homepage appears.

7.8.2. Importing A Configuration File Using The Web Interface For Software Version 72.002 And Above

You can import a configuration file to the alternate configuration segment using the web interface.

In the top menu, select **System -> Flash Operations**. The Flash operations page appears.



The flash operations page for software version 72.002 and above

In the Operations column, click **Upload new**. Select the appropriate file.

Flash Operations

Imported uploaded file to config2

	Contents	Current Operational Status	After Reboot	Operations
Image 1	LIS-15.00.72.002c1		Make active (after reboot)	Flash image
Image 2	LIS-15.00.72.002c1	active	will be active	
Config 1	Configuration (19013 bytes)	active	will be active	
Config 2	Configuration (19619 bytes)		Make active (after reboot)	Upload new
Factory Config	Configuration (12203 bytes)		Make active (after reboot)	

Reboot using Active Configuration
 Reboot the device. The image and config that will be used are shown in green above.

Factory Reset
 Here you can reset the router to factory configuration.
 On reboot, the factory defaults will be running and you will be able to make changes to the configuration.
 A choice of config 1 or config 2 is given in case you have a preference for which config to use (and which to preserve). If you have no preference then either can be used.

The flash operations succeed upload configuration page

If you select 'Flash image and do not reboot', the router will only run this configuration if you click **OK** to return to the Flash Operations page. There you can manually select **Made Active (after reboot)**. Then click **Reboot Now** in the 'Reboot using Active Configuration' section.

7.8.3. Importing A Configuration File Using UCI

You can import a configuration file to any file segment using UCI. To import to config1, enter:

```
root@VA_router:~# uci -c /etc/config/1 import
<paste in config file>
<CTRL-D>
```



NOTE

It is very important that the config file is in the correct format otherwise it will not import correctly.

8. Using The Command Line Interface

This chapter explains how to view the router log files and edit configuration files using a Command Line Interface (CLI) and the Unified Configuration Interface (UCI) system. Some commands may vary between router models.

8.1. Overview Of Some Common Commands

The router has an SSH server typically running on port 22.

The factconf default password for the root user is **admin**. To change the factconf default password, enter:

```
root@VA_router:/# uci set system.main.password="*****"  
root@VA_router:/# uci commit system
```

To reboot the system, enter:

```
root@VA_router:/# reboot
```

The system provides a Unix-like command line. Common Unix commands are available such as ls, cd, cat, top, grep, tail, head, more and less.

Typical pipe and redirect operators are also available, such as: >, >>, <, |

The system log can be viewed using any of the following commands:

```
root@VA_router:/# logread  
root@VA_router:/# logread | tail  
root@VA_router:/# logread -f
```

These commands will show the full log, end of the log (tail) and continuously (-f). Enter

Ctrl-C to stop the continuous output from logread -f.

To view and edit configuration files, the system uses the Unified Configuration Interface (UCI) which is described further on in this chapter. This is the preferred method of editing configuration files. However, you can also view and edit these files using some of the standard Unix tools.

For example, to view a text or configuration file in the system, enter:

```
root@VA_router:/# cat /etc/passwd
```

The command output information shows the following, or similar output.

```
root:x:0:0:root:/root:/bin/ash
daemon:*:1:1:daemon:/var:/bin/false
ftp:*:55:55:ftp:/home/ftp:/bin/false
sftp:*:56:56:sftp:/var:/usr/lib/sftp-server
network:*:101:101:network:/var:/bin/false
nobody:*:65534:65534:nobody:/var:/bin/false
```

To view files in the current folder, enter:

```
root@VA_router:/# ls
bin etc lib opt sbin usr
bkrepos home linuxrc proc sys var
dev init mnt root tmp www
```

For more details add the `-l` argument:

```
root@VA_router:/# ls -l
drwxrwxr-x 2 root root 642 Jul 16 2012 bin
drwxr-xr-x 5 root root 1020 Jul 4 01:27 dev
drwxrwxr-x 1 root root 0 Jul 3 18:41 etc
drwxr-xr-x 1 root root 0 Jul 9 2012 lib
drwxr-xr-x 2 root root 3 Jul 16 2012 mnt
drwxr-xr-x 7 root root 0 Jan 1 1970 overlay
dr-xr-xr-x 58 root root 0 Jan 1 1970 proc
drwxr-xr-x 16 root root 223 Jul 16 2012 rom
drwxr-xr-x 1 root root 0 Jul 3 22:53 root
drwxrwxr-x 2 root root 612 Jul 16 2012 sbin
drwxr-xr-x 11 root root 0 Jan 1 1970 sys
drwxrwxrwt 10 root root 300 Jul 4 01:27 tmp
drwxr-xr-x 1 root root 0 Jul 3 11:37 usr
lrwxrwxrwx 1 root root 4 Jul 16 2012 var -> /tmp
drwxr-xr-x 4 root root 67 Jul 16 2012 www
```

To change the current folder, enter `cd` followed by the desired path:

```
root@VA_router:/# cd /etc/config1
root@VA_router:/etc/config1#
```



NOTE

If the specified directory is actually a link to a directory, the real directory will be shown in the prompt.

To view scheduled jobs, enter:

```
root@VA_router:/# crontab -l  
0 * * * * slapload 00FF5FF92752 TFTP 1 172.16.250.100 69
```

To view currently running processes, enter:

```
root@VA_router:/# ps
```

PID	Uid	Vmsize	stat	Command
1	root	356	S	init
2	root	-	DW	[keventd]
3	root	-	RWN	[ksoftirqd_CPU0]
4	root	-	SW	[kswapd]
5	root	-	SW	[bdflush]
6	root	-	SW	[kupdated]
8	root	-	SW	[mtdblockd]
89	root	344	S	logger -s -p 6 -t
92	root	356	S	init
93	root	348	S	syslogd -C 16
94	root	300	S	klogd
424	root	320	S	wifi up
549	root	364	S	httpd -p 80 -h /www -r VA_router
563	root	336	S	crond -c /etc/crontabs
6712	root	392	S	/usr/sbin/dropbear
6824	root	588	S	/usr/sbin/dropbear
7296	root	444	S	-ash
374	root	344	R	ps ax
375	root	400	S	/bin/sh /sbin/hotplug button
384	root	396	R	/bin/sh /sbin/hotplug button
385	root	-	RW	[keventd]

To search for a process, enter: `pgrep -fl '<process name or part of name>'`:

```
root@VA_router:/# pgrep -fl 'wifi'  
424 root 320 S wifi up
```

To kill a process, enter the PID:

```
root@VA_router:~# kill 424
```

8.2. Using Unified Configuration Interface (UCI)

The system uses Unified Configuration Interface (UCI) for central configuration management. Most common and useful configuration settings can be accessed and configured using the UCI system.

UCI consists of a Command Line Utility (CLI), the files containing the actual configuration data, and scripts that take the configuration data and apply it to the proper parts of the system, such as the networking interfaces. Entering the command 'uci' on its own will display the list of valid arguments for the command and their format.

```
root@VA_router:/lib/config# uci
```

Usage: `uci [<options>] <command> [<arguments>]`

Commands:

```

export [<config>]
import [<config>] changes [<config>] commit [<config>]
add <config> <section-type>
add_list <config>.<section>.<option>=<string> show [<config>[.<section>[.<option>]]] get <config>.<section>[.<option>]
set <config>.<section>[.<option>]=<value> delete <config>[.<section>[.<option>]]
rename <config>.<section>[.<option>]=<name> revert <config>[.<section>[.<option>]] Options:
-c <path> set the search path for config files (default: /etc/config)
-d <str> set the delimiter for list values in uci show
-f <file> use <file> as input instead of stdin
-m when importing, merge data into an existing package
-n name unnamed sections on export (default)
-N don't name unnamed sections
-p <path> add a search path for config change files
-P <path> add a search path for config change files and use as default
-q quiet mode (don't print error messages)
-s force strict mode (stop on parser errors, default)
-S disable strict mode
-X do not use extended syntax on 'show'

```

The table below describes commands for the UCI command line and some further examples of how to use this utility.

Command	Target	Description
commit	[<config>]	Writes changes of the given configuration file, or if none is given, all configuration files, to the filesystem. All "uci set", "uci add", "uci rename" and "uci delete" commands are staged into a temporary location and written to flash at once with "uci commit". This is not needed after editing configuration files with a text editor; but for scripts, GUIs and other programs working directly with UCI files.
export	[<config>]	Exports the configuration in a UCI syntax and does validation.
import	[<config>]	Imports configuration files in UCI syntax.
changes	[<config>]	Lists staged changes to the given configuration file or if none given, all configuration files.
add	<config> <section-type>	Adds an anonymous section of type section-type to the given configuration.
add_list	<config>.<section>.<option>=<string>	Adds the given string to an existing list option.
show	[<config>[.<section>[.<option>]]]	Shows the given option, section or configuration in compressed notation.
get	<config>.<section>[.<option>]	Gets the value of the given option or the type of the given section.
set	<config>.<section>[.<option>]=<value>	Sets the value of the given option, or add a new section with the type set to the given value.
delete	<config>[.<section>[.<option>]]	Deletes the given section or option.
rename	<config>.<section>[.<option>]=<name>	Renames the given option or section to the given name.
revert	<config>[.<section>[.<option>]]	Deletes staged changes to the given option, section or configuration file.



NOTE

All operations do not act directly on the configuration files. A commit command is required after you have finished your configuration.

```
root@VA_router:~# uci commit
```

Using uci commit to avoid router reboot

After changing the port, uhttpd listens on from 80 to 8080 in the file `/etc/config/uhttpd`; save it, then enter:

```
root@VA_router:~# uci commit uhttpd
```

Then enter:

```
root@VA_router:~# /etc/init.d/uhttpd restart
```

For this example, the router does not need to reboot as the changes take effect when the specified process is restarted.

8.3. Export A Configuration

Using the `uci export` command it is possible to view the entire configuration of the router or a specific package. Using this method to view configurations does not show comments that are present in the configuration file:

```
root@VA_router:~# uci export httpd
package 'httpd'
config 'httpd'
option 'port' '80'
option 'home' '/www'
```

8.4. Show A Configuration Tree

The configuration tree format displays the full path to each option. This path can then be used to edit a specific option using the `uci set` command.

To show the configuration 'tree' for a given config, enter:

```
root@VA_router:/# uci show network
network.loopback=interface
network.loopback.ifname=lo
network.loopback.proto=static
network.loopback.ipaddr=127.0.0.1
network.loopback.netmask=255.0.0.0
network.lan=interface
network.lan.ifname=eth0
network.lan.proto=dhcp
network.wan=interface
network.wan.username=foo
network.wan.password=bar
network.wan.proto=3g
network.wan.device=/dev/ttyACM0
network.wan.service=umts
network.wan.auto=0
network.wan.apn=arkessa.com
network.@va_switch[0]=va_switch
network.@va_switch[0].eth0=A B C
network.@va_switch[0].eth1=D
```

It is also possible to display a limited subset of a configuration:

```
root@VA_router:/# uci show network.wan
network.wan=interface
network.wan.username=foo
network.wan.password=bar
network.wan.proto=3g
network.wan.device=/dev/ttyACM0
network.wan.service=umts
network.wan.auto=0
network.wan.apn=hs.vodafone.ie
```

8.5. Display Just The Value Of An Option

To display a specific value of an individual option within a package, enter:

```
root@VA_router:~# uci get httpd.@httpd[0].port
80
root@VA_router:~#
```

8.6. High Level Image Commands

To show the image running currently, enter:

```
root@VA_router:~# vacmd show current image
```

To set the image to run on next reboot, enter:

```
root@VA_router:~# vacmd set next image [image1|image2|altimage]
```

```
root@VA_router:~# reboot
```

8.7. Format Of Multiple Rules

When there are multiple rules next to each other, UCI uses array-like references for them. For example, if there are 8 NTP servers, UCI will let you reference their sections as `timeserver.@timeserver[0]` for the first section; or `timeserver.@timeserver[7]` for the last section.

You can also use negative indexes, such as `timeserver.@timeserver[-1]` '-1' means the last one, and '-2' means the second-to-last one. This is useful when appending new rules to the end of a list.

```
root@VA_router:/# uci show va_eventd
va_eventd.main=va_eventd
va_eventd.main.enabled=yes
va_eventd.main.event_queue_file=/tmp/event_buffer
va_eventd.main.event_queue_size=128K
va_eventd.@conn_tester[0]=conn_tester
va_eventd.@conn_tester[0].name=Pinger
va_eventd.@conn_tester[0].enabled=yes
va_eventd.@conn_tester[0].type=ping
va_eventd.@conn_tester[0].ping_dest_addr=192.168.250.100
va_eventd.@conn_tester[0].ping_success_duration_sec=5
va_eventd.@target[0]=target
va_eventd.@target[0].name=MonitorSyslog
va_eventd.@target[0].enabled=yes
va_eventd.@target[0].type=syslog
va_eventd.@target[0].target_addr=192.168.250.100
va_eventd.@target[0].conn_tester=Pinger
va_eventd.@target[0].suppress_duplicate_forwardings=no
va_eventd.@forwarding[0]=forwarding
va_eventd.@forwarding[0].enabled=yes
va_eventd.@forwarding[0].className=ethernet
va_eventd.@forwarding[0].target=MonitorSyslog
va_eventd.@forwarding[1]=forwarding
va_eventd.@forwarding[1].enabled=yes
va_eventd.@forwarding[1].className=auth
va_eventd.@forwarding[1].target=MonitorSyslog
va_eventd.@forwarding[2]=forwarding
va_eventd.@forwarding[2].enabled=yes
va_eventd.@forwarding[2].className=adsl
va_eventd.@forwarding[2].target=MonitorSyslog
va_eventd.@forwarding[3]=forwarding
va_eventd.@forwarding[3].enabled=yes
va_eventd.@forwarding[3].className=ppp
va_eventd.@forwarding[3].target=MonitorSyslog
```

8.8. Configuration Files

The table below lists common package configuration files that can be edited using uci commands. Other configuration files may also be present depending on the specific options available on the router.

File	Description
Management	
/etc/config/autoload	Boot up Activation behaviour (typically used in factconf)
/etc/config/httpclient	Activator addresses and urls
/etc/config/monitor	Monitor details
Basic	
/etc/config/dropbear	SSH server options
/etc/config/dhcp	Dnsmasq configuration and DHCP settings
/etc/config/firewall	NAT, packet filter, port forwarding, etc.
/etc/config/network	Switch, interface, L2TP and route configuration
/etc/config/system	Misc. system settings including syslog
Other	
/etc/config/snmpd	SNMPd settings
/etc/config/uhttpd	Web server options (uHTTPd)
/etc/config/strongswan	IPSec settings

8.9. Configuration File Syntax

The configuration files usually consist of one or more config statements, so-called sections with one or more option statements defining the actual values.

Below is an example of a simple configuration file.

```
package 'example'
config 'example' 'test'
option 'string' 'some value'
option 'boolean' '1'
list 'collection' 'first item'
list 'collection' 'second item'
```

The config 'example' 'test' statement defines the start of a section with the type example and the name test. There can also be so-called anonymous sections with only a type, but no name identifier. The type is important for the processing programs to decide how to treat the enclosed options.

The option 'string' 'some value' and option 'boolean' '1' lines define simple values within the section.



NOTE

There are no syntactical differences between text and boolean options. Per convention, boolean options may have one of the values '0', 'no', 'off' or 'false' to specify a false value or '1', 'yes', 'on' or 'true' to specify a true value.

In the lines starting with a list keyword, an option with multiple values is defined. All list statements that share the same name collection in our example will be combined into a single list of values with the same order as in the configuration file.

The indentation of the option and list statements is a convention to improve the readability of the configuration file but it is not syntactically required.

Usually you do not need to enclose identifiers or values in quotes. Quotes are only required if the enclosed value contains spaces or tabs. Also it is legal to use double-quotes instead of single-quotes when typing configuration options.

All of the examples below are valid syntax.

```
option example value
option 'example' value
option example "value"
option "example" 'value'
option 'example' "value"
```

In contrast, the following examples are not valid syntax.

```
option 'example' "value'
```

Quotes are unbalanced.

```
option example some value with space
```

Missing quotes around the value.

It is important to note that identifiers and config file names may only contain the characters a-z, A-Z, 0-9 and `_`. However, option values may contain any character, as long they are properly quoted.

9. Upgrading Router Firmware

This chapter describes how to upgrade router firmware. The upgrade process is as follows:

- Firmware is transferred to the device.
- Firmware is checked to ensure there are no corruptions.
- Firmware is saved to persistent storage.
- Data in persistent storage is validated.

To avoid any unrecoverable errors during the process, you must follow several safety steps described in this chapter.

On successful completion of the process, you can restart the device running the new firmware.

9.1. Software Versions

If you have software versions prior to 72.002, go to 'Upgrading router firmware for software versions pre-72.002'.

If you have software version 72.002 or above, go to 'Upgrading router firmware for software versions 72.002 and above'.

To upgrade firmware using CLI, for any software version, go to 'Upgrading firmware using CLI'.

9.2. Identify Your Software Version

To check which software version your router is running, in the top menu, browse to **Status -> Overview**

Status	
System	
Router Name	GW0000
Router Model	Virtual Access GW0031W-AA0179E
Firmware Version	VIE-16.00.55
Current Image/Config	image2 / config2
Kernel Version	3.2.12
Local Time	Fri Aug 5 11:43:52 2016
Uptime	0h 10m 8s
Load Average	0.27, 0.35, 0.31

The status page showing a software version prior to 72.002

Status

System

Router Name	
Router Model	
Firmware Version	VIE-16.00.55
Current Image/Config	image2 / config2
Kernel Version	3.2.12
Local Time	Fri Aug 5 11:43:52 20
Uptime	0h 10m 8s
Load Average	0.27, 0.35, 0.31

The status page showing software version 72.002

In the Firmware Version row, the first two digits of the firmware version identify the hardware platform, for example LIS-15; while the remaining digits: .00.72.002, show the software version.

9.3. Upgrading Router Firmware For Software Version 72.002 And Above

Copy the new firmware issued by Westermo to a PC connected to the router.

Flash Operations

Contents	Current Operational Status	After Reboot	Operations
Image 1 LIS-15 00 72 002c1	active	will be active	
Image 2 LIS-15 00 72 002c1		Make active (after reboot)	Flash image
Config 1 Configuration (19613 bytes)	active	will be active	
Config 2 Configuration (19637 bytes)		Make active (after reboot)	Upload new
Factory Config Configuration (12203 bytes)		Make active (after reboot)	

Reboot using Active Configuration
Reboot the device. The image and config that will be used are shown in green above.

Reboot Now

Factory Reset
Here you can reset the router to factory configuration.
On reboot, the factory defaults will be running and you will be able to make changes to the configuration.
A choice of config 1 or config 2 is given in case you have a preference for which config to use (and which to preserve). If you have no preference then either can be used.

Factory Reset Config 1 Factory Reset Config 2

The flash operations page

In the top menu, select **System tab -> Flash operations**. The Flash operations page appears.

Under Flash Operations, click **Flash Image**. Only the inactive image is available to flash. Select the appropriate image and then wait until image has loaded.

NOTE

This process may take a while depending on the available connection speed. When the image has loaded, the Update Firmware page appears.

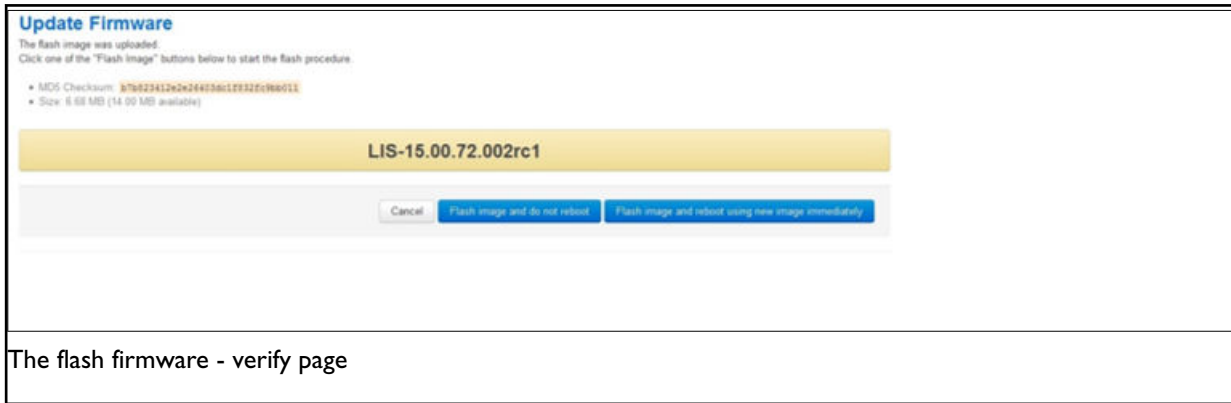

The flash firmware - verify page

Click either: **Flash image and do not reboot**, or **Flash image and reboot using new image immediately**. The 'Firmware update is being applied' message appears.

When the firmware update is complete, the Update Firmware page appears. There are various messages, depending on which option you selected, or if any corruptions have occurred.

9.4. Upgrading Router Firmware For Software Versions Pre-72.002

Copy the new firmware issued by Westermo to a PC connected to the router.

In the top menu, select **System tab -> Backup/Flash Firmware**. The Flash operations page appears.

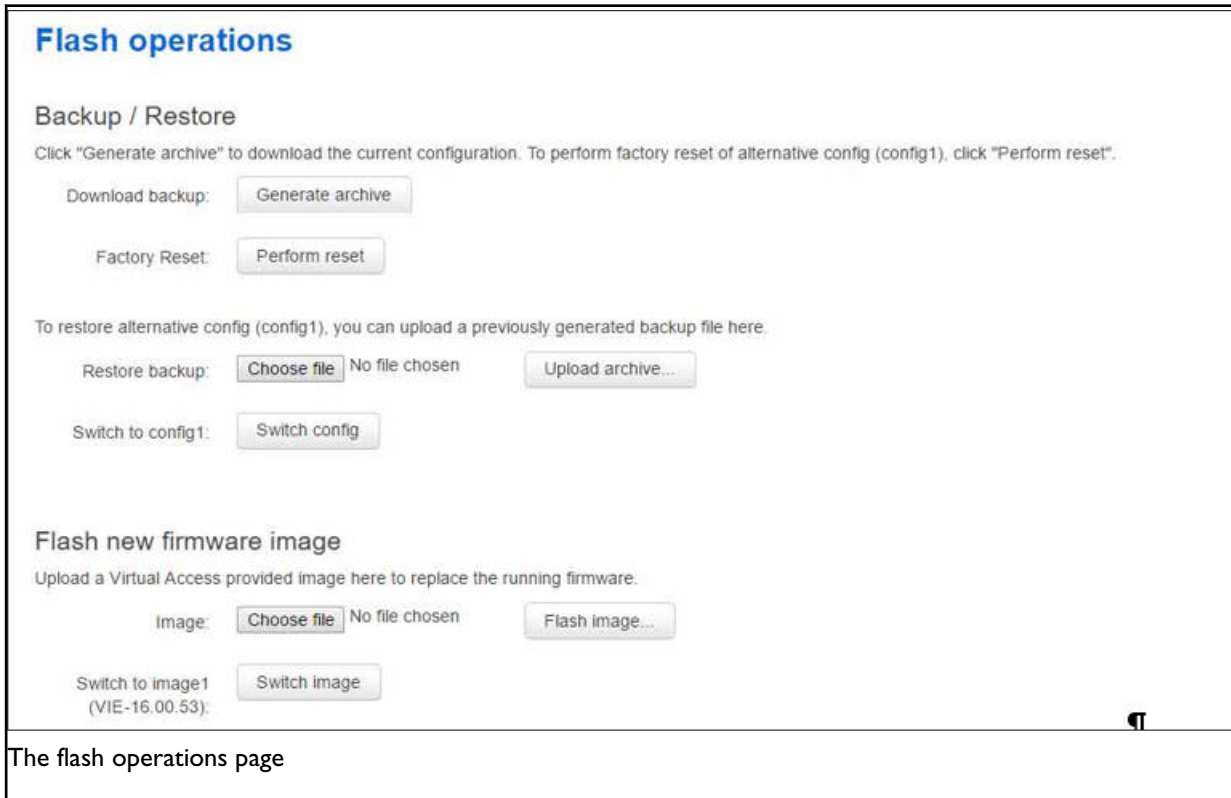

The flash operations page

Under Flash new firmware image, click **Choose File** or **Browse**.



NOTE

The button will vary depending on the browser you are using.

Select the appropriate image and then click **Flash Image**. The Flash Firmware – Verify page appears.

Flash Firmware - Verify

The flash image was uploaded. Below is the checksum and file size listed, compare them with the original file to ensure data integrity. Click "Proceed" below to start the flash procedure.

- Checksum: `4f5aa18ebb3ec575ce16d0c9e18273af`
- Size: 7.63 MB (14.00 MB available)

The flash firmware - verify page

Click **Proceed**. The System – Flashing page appears.

System - Flashing...

The system is flashing now.
DO NOT POWER OFF THE DEVICE!
Wait a few minutes until you try to reconnect. It might be necessary to renew the address of your computer to reach the device again, depending on your settings.

 Waiting for router...

The system flashing page

When the 'waiting for router' icon disappears, the upgrade is complete, and the login homepage appears.

To verify that the router has been upgraded successfully, click **Status** in the top menu. The Firmware Version shows in the system list.

Status

System

Router Name	GW0000
Router Model	Virtual Access GW0031W-AA0179E
Firmware Version	VIE-16.00.55
Current Image/Config	image2 / config2
Kernel Version	3.2.12
Local Time	Fri Aug 5 11:43:52 2016
Uptime	0h 10m 8s
Load Average	0.27, 0.35, 0.31

The system status list page

9.5. Flash Image And Do Not Reboot Option

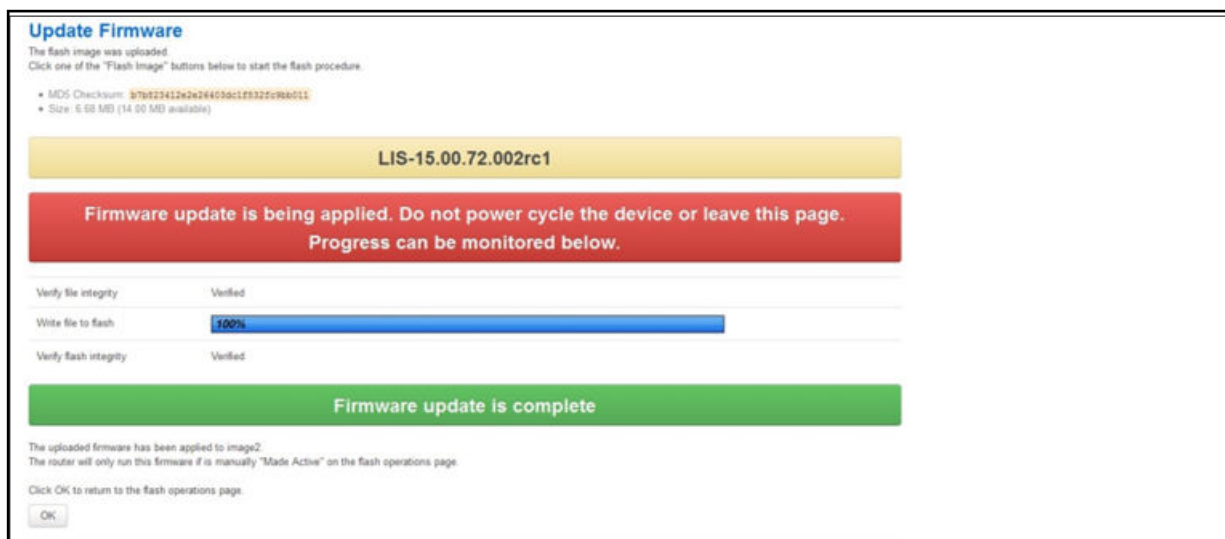

The firmware update page after 'do not reboot' option selected

If you select 'Flash image and do not reboot', the router will only run the firmware if you click **OK** to return to the Flash Operations page. There you can manually select **Made Active (after reboot)**. Then click **Reboot Now** in the 'Reboot using Active Configuration' section.

9.6. Update Flash Image And Reboot Using New Image Immediately Option

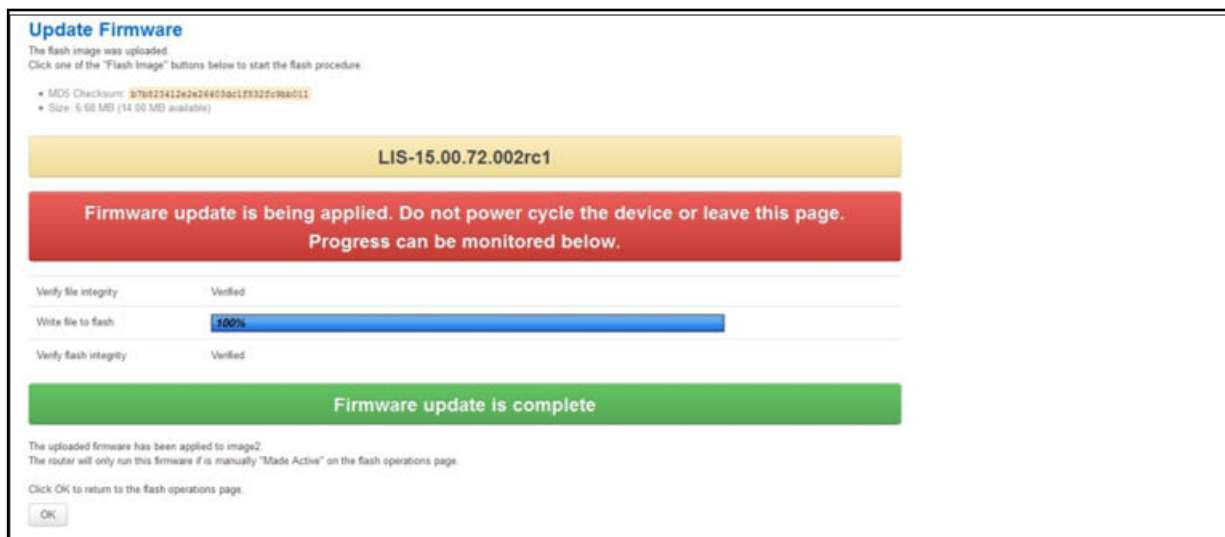

The firmware update page after 'update flash image an reboot' option selected

If you select 'Update flash image and reboot using new image immediately' and the overall validation and flashing process has succeeded, the router will reboot immediately. To regain access to the router you must login again. If any part of the processes encounters an error the reboot does **not** occur and a report is given.

9.7. Possible File Corruption

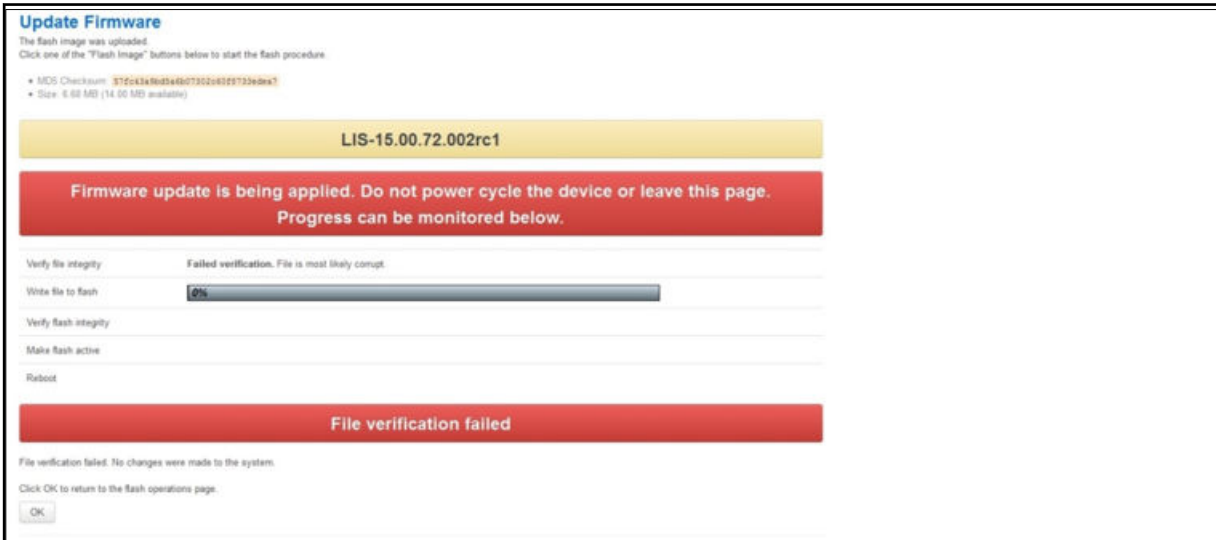

The screenshot shows the 'Update Firmware' interface. At the top, it says 'Update Firmware' and 'The flash image was uploaded. Click one of the "Flash Image" buttons below to start the flash procedure.' Below this, there are two bullet points: '• MD5 Checksum: 372c3148014607332c0103733e0e1?' and '• Size: 6.68 MB (14.50 MB available)'. A yellow bar displays the firmware version 'LIS-15.00.72.002rc1'. A red bar contains the message: 'Firmware update is being applied. Do not power cycle the device or leave this page. Progress can be monitored below.' Below this, there are several rows of progress indicators: 'Verify file integrity' (Failed verification. File is most likely corrupt), 'Write file to flash' (0%), 'Verify flash integrity', 'Make flash active', and 'Reboot'. A large red bar at the bottom states 'File verification failed'. Below this, it says 'File verification failed. No changes were made to the system.' and 'Click OK to return to the flash operations page.' with an 'OK' button.

The firmware update failure page

In the unfortunate event that the firmware upgrade fails, the 'Failed verification File is most likely corrupt' or similar message will appear in the Verify file integrity row. No changes will be made to the system and the general message **File verification failed** appears.

9.8. Verify The Firmware Has Been Upgraded Successfully

To check the firmware version, in the top menu, browse to **System -> Flash Operations**, or after router reboots, in the top menu, click **Status**. The Firmware Version shows in the system list and also in the right top corner of the menu bar.

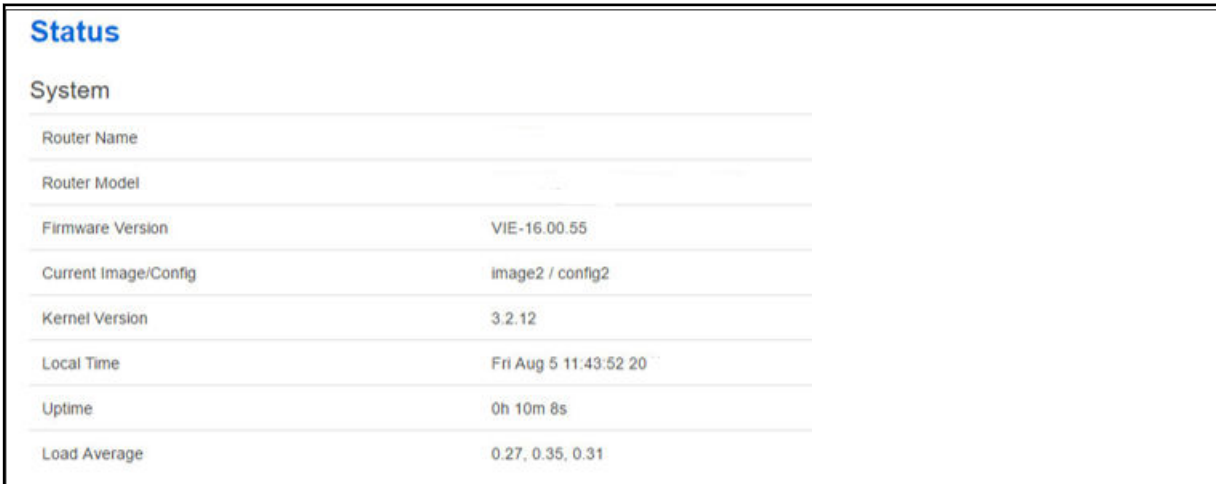

The screenshot shows the 'Status' page. The title is 'Status'. Under the 'System' section, there is a table with the following information:

Router Name	
Router Model	
Firmware Version	VIE-16.00.55
Current Image/Config	image2 / config2
Kernel Version	3.2.12
Local Time	Fri Aug 5 11:43:52 20
Uptime	0h 10m 8s
Load Average	0.27, 0.35, 0.31

The system status list showing current firmware version

9.9. Upgrading Firmware Using CLI

Transfer File to Router

To upgrade firmware using CLI, you will need a TFTP server on a connected PC or SCP available.

Open up an SSH session to the router.

Enter in the relevant username and password.

To access the temp folder, enter **cd /tmp**

The output shows the available application:

TFTP using curl

Enter the following command:

```
curl tftp://x.x.x.x/LIS-15.00.72.002.image -o /tmp/LIS-15.00.72.002.image
```

where x.x.x.x is the IP of your PC, **-o** is local file name to store.

SCP

Secure Copy (SCP) is a part of Secure Shell (SSH) and enables file transfers to the router using authentication and encryption. It is different to TFTP, which uses UDP, while SCP uses a TCP connection. On Unix machines, SCP is a standard part of the system; on Windows it requires an additional application. The usage example below is for a Unix machine and therefore assumes the image file is in the current folder.

```
scp LIS-15.00.72.002.image root@x.x.x.x:/tmp/LIS-15.00.72.002.image
```

Where the first argument 'LIS-15.00.72.002.image' in SCP is the source and the second argument 'tmp/LIS-15.00.72.002.image' is the destination path, enter root as the username to connect to x.x.x.x IP address. After you execute the above command you will be asked to provide a root password. At this stage the output shows the process of copying the software file into destination directory.

```
root@192.168.100.1's password:  
LIS-15.00.72.000.image 100% 6812KB 2.2MB/s 00:03
```

9.9.1. Flashing

When downloaded firmware verification succeeds, the new image can be written to flash. To write the image into the alternative image, enter:

```
mtm write LIS-15.00.72.002.image altimage
```



NOTE

This is an example, substitute the correct file name.

9.9.2. Flash Verification After Flashing

After the write process has finished, you must complete a post verification of the firmware.

To verify the checksum of downloaded firmware, enter:

```
va_image_csum.sh /tmp/LIS-15.00.72.002.image
```

The checksum of the downloaded binary is shown:

```
08761cd03e33c569873bcc24cf2b7389 7006920 LIS-15.00.72.002 This MD5
```

To verify the checksum of written firmware, enter:

```
va_image_csum.sh alt
```

After a while the checksum will be calculated:

```
Calculating checksum.....
```

```
08761cd03e33c569873bcc24cf2b7389 7006920 LIS-15.00.72.002 This MD5
```

Verify and compare the checksum with the MD5 sum of the downloaded image.

If the checksum of the written firmware in altimage matches the one from the downloaded image in /tmp, the new firmware has been programmed successfully.

9.9.3. Set Up An Alternative Image

Provided the programming has succeeded, you can set it as the next image to use after reboot; enter:

```
vacmd set next image altimage
```

To reboot using the new firmware, enter:

```
reboot
```

10. System Settings

The system section contains settings that apply to the most basic operation of the system, such as the host name, time zone, logging details, NTP server, language and style.

The host name appears in the top left-hand corner of the interface menu bar. It also appears when you open a Telnet or SSH session.

Note: this document shows no host name in screen shots. Throughout the document we use the host name 'VA_router'.

The system configuration contains a logging section for the configuration of a syslog client.

10.1. Syslog Overview

Most syslog settings appear in the main System Configuration page.

Syslog messages have a timestamp, source facility, priority, and message section. Often the message section begins with an optional tag identifying the usermode program name and process ID responsible for the message.

Messages can be stored locally and also forwarded remotely. Separate filter options apply to each case. At a broad level, you can set the minimum severity level for local and remote targets; only messages with a priority more severe than the configured level will be recorded.

Kernel messages are recorded separately in their own buffer. However, for convenience, these are copied to the system log automatically so that a unified system log is available.

In addition, you can also define filter rules to determine how particular log messages are handled. For example, you may decide that certain debug messages are directed into their own log file, to avoid cluttering up the main system log, and to save bandwidth if delivering to a remote syslog server. You can define filters to be applied to local and remote targets, or both. A filter matches specific log messages and then determines an action for them.

Configuration Package Used

Package	Sections
System	main syslog_filter timeserver
luci	main

10.2. Configuring System Properties

To set your system properties, select **System -> System**. There are five sections in the System page.

Section	Description
General settings	Configure host name, local time and time zone.
Logging	Configure a router to log to a server. You can configure a syslog client in this section.
Language and style	Configure the router's web language and style.
Time synchronization	Configure the NTP server in this section.
Audit configuration	Configures auditing of configuration changes and shell execution.

10.2.1. General Settings

System
Here you can configure the basic aspects of your device like its hostname or the timezone.

System Properties

General Settings | **Logging** | Language and Style

Local Time: Fri Mar 20 12:45:18 2015

Hostname:

Timezone: ▾

Time Synchronization

Time Synchronization is not configured yet.

General settings in system properties

Web Field/UCI/Package Option	Description
Web: Local Time	Sets the local time and syncs with browser. You can manually configure on CLI, using: date -s YYYY.MM.DD-hh:mm:ss
Web: hostname UCI: system.main.hostname Opt: hostname	Specifies the hostname for this system.
Web: Timezone UCI: system.main.timezone Opt: timezone	Specifies the time zone that the date and time should be rendered in by default.
Web: n/a UCI: system.main.timezone Opt: time_save_interval_min	Defines the interval in minutes to store the local time for use on next reboot.

10.2.2. Logging

System Properties

General Settings | **Logging** | Language and Style

Log Storage: File

System log buffer size: 400 kiB

System log buffer size for RAM: 64 kiB

External system log server: 0.0.0.0

External system log server port: 514

External system backup log server: 0.0.0.0

External system backup log server port: 514

Log file location: /root/syslog.messages

Rotated log files to keep: 3

Max Age of rotated log files: 0 hours

Custom log hostname:

Log output level: Info

Remote log output level: Debug

The logging section in system properties

Web Field/UCI/Package Option	Description									
Web: Log storage UCI: system.main.log_type Opt: log_type	Defines the system log storage type. Messages stored in RAM can be seen using logread. Note: system log stored in RAM will be lost on reboot. <table border="1"> <thead> <tr> <th>Web value</th> <th>Description</th> <th>UCI</th> </tr> </thead> <tbody> <tr> <td>RAM</td> <td>Store system log in RAM. Lost on reboot. Viewed using logread.</td> <td>circular</td> </tr> <tr> <td>File</td> <td>Store system log in flash. Maintained through reboot. Viewed using cat/log</td> <td>file</td> </tr> </tbody> </table>	Web value	Description	UCI	RAM	Store system log in RAM. Lost on reboot. Viewed using logread.	circular	File	Store system log in flash. Maintained through reboot. Viewed using cat/log	file
Web value	Description	UCI								
RAM	Store system log in RAM. Lost on reboot. Viewed using logread.	circular								
File	Store system log in flash. Maintained through reboot. Viewed using cat/log	file								
Web: System log buffer size UCI: system.main.log_size Opt: log_size	File log buffer size in KB. Note: when the file reaches the configured size it is copied to the archive file (log_file_name.0). <table border="1"> <thead> <tr> <th>Range</th> <th></th> </tr> </thead> <tbody> <tr> <td>16</td> <td>16KB</td> </tr> </tbody> </table>	Range		16	16KB					
Range										
16	16KB									
Web: System log buffer size for RAM UCI: system.main.log_size_ram Opt: log_size_ram	RAM log buffer size in KB. <table border="1"> <thead> <tr> <th>Range</th> <th></th> </tr> </thead> <tbody> <tr> <td>16</td> <td>16K</td> </tr> </tbody> </table>	Range		16	16K					
Range										
16	16K									
Web: External system log server UCI: system.main.log_ip Opt: log_ip	External syslog server IP address. If defined, syslog messages will be sent in addition to local storage.									
Web: External system log server port UCI: system.main.log_port Opt: log_port	External syslog server port number. <table border="1"> <thead> <tr> <th>Range</th> <th></th> </tr> </thead> <tbody> <tr> <td>514</td> <td></td> </tr> </tbody> </table>	Range		514						
Range										
514										
Web: External system backup log server UCI: system.main.log_ip_backup Opt: log_ip_backup	Backup external syslog server IP address. If defined, syslog messages will be sent here in addition to the main log server. <table border="1"> <thead> <tr> <th>Range</th> <th>IP or FQDN</th> </tr> </thead> <tbody> <tr> <td>0.0.0.0</td> <td></td> </tr> </tbody> </table>	Range	IP or FQDN	0.0.0.0						
Range	IP or FQDN									
0.0.0.0										
Web: External system backup log server port UCI: system.main.log_port_backup Opt: log_port_backup	External syslog server port number for use with backup server <table border="1"> <thead> <tr> <th>Range</th> <th></th> </tr> </thead> <tbody> <tr> <td>51</td> <td></td> </tr> </tbody> </table>	Range		51						
Range										
51										
Web: Log file location UCI: system.main.log_file Opt: log_file	Defines the file path for log storage when log storage is set to 'file'. Note: when the file reaches the configured size it is copied to the archive file (log_file_name.0). Set to: root/syslog.messages <table border="1"> <thead> <tr> <th>Range</th> <th></th> </tr> </thead> <tbody> <tr> <td>/root/syslog</td> <td></td> </tr> </tbody> </table>	Range		/root/syslog						
Range										
/root/syslog										
Web: Rotated log files to keep UCI: system.main.log_file_count Opt: log_file_count	Defines the file number of archive files for storage in flash when Log Storage is set to 'file'. When the system log file reaches the configured size it is copied to the archive file (log_file_name.0). Existing archive files are copied to log_file_name.(x+1). <table border="1"> <thead> <tr> <th>Range</th> <th></th> </tr> </thead> <tbody> <tr> <td></td> <td></td> </tr> </tbody> </table>	Range								
Range										

Web Field/UCI/Package Option	Description																											
	<table border="1"> <tr> <td>1</td> <td>Store 1 archive log file in flash</td> </tr> </table>	1	Store 1 archive log file in flash																									
1	Store 1 archive log file in flash																											
Web: Max Age of rotated log files UCI: system.main.log_age Opt: log_age	Defines the maximum duration in hours before archive syslog files are deleted. Set to 0 to define no age limit. <table border="1"> <tr> <td>Range</td> <td></td> </tr> <tr> <td>0</td> <td>No age limit</td> </tr> </table>	Range		0	No age limit																							
Range																												
0	No age limit																											
Web: Custom log hostname UCI: system.main.log_hostname Opt: log_hostname	Defines a custom host name for syslog messages. Magic values %hostname (system hostname), %ser (serial), and%mon (Monitor dev_reference) are also recognised. <table border="1"> <tr> <td>Range</td> <td></td> </tr> <tr> <td>Empty</td> <td>User router hostname for syslog messages.</td> </tr> </table>	Range		Empty	User router hostname for syslog messages.																							
Range																												
Empty	User router hostname for syslog messages.																											
Web: Log output level UCI: system.main.conloglevel Opt: conloglevel	Sets the maximum log output level severity for system events. System events are written to the system log. Messages with a lower level or level equal to the configured level are displayed on the console using the logread command, or alternatively written to a flash file, if configured to do so. <table border="1"> <thead> <tr> <th>Web value</th> <th>Description</th> <th>UCI</th> </tr> </thead> <tbody> <tr> <td>Debug</td> <td>Information useful to developers for debugging the application</td> <td>8</td> </tr> <tr> <td>Info</td> <td>Normal operational messages that require no action</td> <td>7</td> </tr> <tr> <td>Notice</td> <td>Events that are unusual, but not error conditions</td> <td>6</td> </tr> <tr> <td>Warning</td> <td>May indicate that an error will occur if action is not taken</td> <td>5</td> </tr> <tr> <td>Error</td> <td>Error conditions</td> <td>4</td> </tr> <tr> <td>Critical</td> <td>Critical conditions</td> <td>3</td> </tr> <tr> <td>Alert</td> <td>Should be addressed immediately</td> <td>2</td> </tr> <tr> <td>Emergency</td> <td>System is unusable</td> <td>1</td> </tr> </tbody> </table>	Web value	Description	UCI	Debug	Information useful to developers for debugging the application	8	Info	Normal operational messages that require no action	7	Notice	Events that are unusual, but not error conditions	6	Warning	May indicate that an error will occur if action is not taken	5	Error	Error conditions	4	Critical	Critical conditions	3	Alert	Should be addressed immediately	2	Emergency	System is unusable	1
Web value	Description	UCI																										
Debug	Information useful to developers for debugging the application	8																										
Info	Normal operational messages that require no action	7																										
Notice	Events that are unusual, but not error conditions	6																										
Warning	May indicate that an error will occur if action is not taken	5																										
Error	Error conditions	4																										
Critical	Critical conditions	3																										
Alert	Should be addressed immediately	2																										
Emergency	System is unusable	1																										
Web: Remote log output level UCI: system.main.remoteloglevel Opt: remoteloglevel	Sets the maximum log output level severity for system events sent to remote syslog server. <table border="1"> <thead> <tr> <th>Web value</th> <th>Description</th> <th>UCI</th> </tr> </thead> <tbody> <tr> <td>Debug</td> <td>Information useful to developers for debugging the application</td> <td>8</td> </tr> <tr> <td>Info</td> <td>Normal operational messages that require no action</td> <td>7</td> </tr> <tr> <td>Notice</td> <td>Events that are unusual, but not error conditions</td> <td>6</td> </tr> <tr> <td>Warning</td> <td>May indicate that an error will occur if action is not taken</td> <td>5</td> </tr> <tr> <td>Error</td> <td>Error conditions</td> <td>4</td> </tr> <tr> <td>Critical</td> <td>Critical conditions</td> <td>3</td> </tr> <tr> <td>Alert</td> <td>Should be addressed immediately</td> <td>2</td> </tr> <tr> <td>Emergency</td> <td>System is unusable</td> <td>1</td> </tr> </tbody> </table>	Web value	Description	UCI	Debug	Information useful to developers for debugging the application	8	Info	Normal operational messages that require no action	7	Notice	Events that are unusual, but not error conditions	6	Warning	May indicate that an error will occur if action is not taken	5	Error	Error conditions	4	Critical	Critical conditions	3	Alert	Should be addressed immediately	2	Emergency	System is unusable	1
Web value	Description	UCI																										
Debug	Information useful to developers for debugging the application	8																										
Info	Normal operational messages that require no action	7																										
Notice	Events that are unusual, but not error conditions	6																										
Warning	May indicate that an error will occur if action is not taken	5																										
Error	Error conditions	4																										
Critical	Critical conditions	3																										
Alert	Should be addressed immediately	2																										
Emergency	System is unusable	1																										
Web: n/a UCI: system.main.audit_shell Opt: audit_shell	Log every command executed in shell. <table border="1"> <tr> <td>1</td> <td>Enable</td> </tr> <tr> <td>0</td> <td>Disable</td> </tr> </table>	1	Enable	0	Disable																							
1	Enable																											
0	Disable																											
Web: n/a UCI: system.main.audit_cfg Opt: audit_cfg	Log changes made to configuration file through any interface. <table border="1"> <tr> <td>1</td> <td>Enable</td> </tr> <tr> <td>0</td> <td>Disable</td> </tr> </table>	1	Enable	0	Disable																							
1	Enable																											
0	Disable																											
Web: n/a UCI: system.main.audit_cfg_hul_interval_h ours Opt: audit_cfg_hul_interval_hours	Defines the interval, in hours, at which configuration changes are uploaded to Activator. Set to 0 to disable. <table border="1"> <tr> <td>Range</td> <td></td> </tr> </table>	Range																										
Range																												

Web Field/UCI/Package Option	Description
	6 6 hours
Web: n/a UCI: system.main.audit_cfg_max_size_kb Opt: audit_cfg_max_size_kb	Defines the maximum size audit data can take in flash in 1024 byte units. Range 1024 6 hours

10.2.3. Language And Style

System Properties

General Settings | Logging | Language and Style

Language: auto

Design: Rootstrap

Time Synchronization

Time Synchronization is not configured yet. [Setup Time Synchronization](#)

The language and style section in system properties

Web Field	Description
Language	Sets the language to 'auto' or 'English'. Auto English
Design	Sets the router's style.

10.2.4. Audit Configuration

System

Here you can configure the basic aspects of your device like its hostname or the timezone.

System Properties

General Settings | Logging | Language and Style | Audit Configuration

Track Config Changes: Record all config changes in /root/changelog and as patches in flash (/root/cfg_patches). Display using the 'changes' command.

Changelog File Location: /root/changelog

Logfile Size (kB): 200

Rotated Changelog Files To Keep: 4

Audit Data Max Size (kB): 1024 When exceeded, patches are merged together to save space. Set to 0 to disable patch generation.

Config Changes Upload Interval (hours): 6 Rate at which config changes are uploaded to Activator. Set 0 to disable.

Shell Audit: Log shell commands to syslog

Web Audit: Log management web access to syslog

Web Audit Level: 1 - actions invoked via web page Amount of detail to log (cumulative)

The audit configuration section in system properties

Web Field/UCI/Package Option	Description															
Web: Track Config Changes UCI: system.main.audit_cfg Opt: audit_cfg	Any changes made to configuration file through any interface are logged to syslog.															
Web: Changelog File Location UCI: system.main.audit_cfg_log_file Opt: audit_cfg_log_file	Defines the location of the configuration change log. <table border="1"> <tr> <td>Range</td> <td></td> </tr> <tr> <td>/root/changelog</td> <td></td> </tr> </table>	Range		/root/changelog												
Range																
/root/changelog																
Web: Logfile Size (kB) UCI: system.main.audit_cfg_log_size Opt: audit_cfg_log_size	Defines the maximum size of the configuration change log file in KB. <table border="1"> <tr> <td>Range</td> <td></td> </tr> <tr> <td>200</td> <td>200KB</td> </tr> </table>	Range		200	200KB											
Range																
200	200KB															
Web: Rotated Changelog Files to Keep UCI: system.main.audit_cfg_log_count Opt: audit_cfg_log_count	Defines the maximum number of configuration change log files to store. <table border="1"> <tr> <td>Range</td> <td></td> </tr> <tr> <td>4</td> <td>Store 4 changelog files before rotating.</td> </tr> </table>	Range		4	Store 4 changelog files before rotating.											
Range																
4	Store 4 changelog files before rotating.															
Web: Audit Data Max Size (kB) UCI: system.main.audit_cfg_max_size_kb Opt: audit_cfg_max_size_kb	Defines the maximum size audit data can take in flash in KB. <table border="1"> <tr> <td>Range</td> <td></td> </tr> <tr> <td>1024</td> <td></td> </tr> </table>	Range		1024												
Range																
1024																
Web: Config Changes Upload Interval UCI: system.main.audit_cfg_hul_interval_hours Opt: audit_cfg_hul_interval_hours	Defines the interval, in hours, at which configuration change messages are uploaded to Activator: Set to 0 to disable. <table border="1"> <tr> <td>Range</td> <td></td> </tr> <tr> <td>6</td> <td>6 hours</td> </tr> </table>	Range		6	6 hours											
Range																
6	6 hours															
Web: Shell Audit UCI: system.main.audit_shell Opt: audit_shell	Every command executed in shell is logged to syslog. <table border="1"> <tr> <td>1</td> <td>Enabled</td> </tr> <tr> <td>0</td> <td>Disabled</td> </tr> </table>	1	Enabled	0	Disabled											
1	Enabled															
0	Disabled															
Web: Web Audit UCI: luci.main.audit_req Opt: audit_req	Enables logging management web access to syslog. <table border="1"> <tr> <td>1</td> <td>Enabled</td> </tr> <tr> <td>0</td> <td>Disabled</td> </tr> </table>	1	Enabled	0	Disabled											
1	Enabled															
0	Disabled															
Web: Web Audit Level UCI: luci.main.audit_shell Opt: audit_level	Defines the type of web operation to be logged to syslog. <table border="1"> <thead> <tr> <th>Web value</th> <th>Description</th> <th>UCI</th> </tr> </thead> <tbody> <tr> <td>1</td> <td>Actions invoked via web page</td> <td>1</td> </tr> <tr> <td>2</td> <td>Config and status pages</td> <td>2</td> </tr> <tr> <td>3</td> <td>config , status and polled pages</td> <td>3</td> </tr> <tr> <td>4</td> <td>comprehensive URL logging</td> <td>4</td> </tr> </tbody> </table>	Web value	Description	UCI	1	Actions invoked via web page	1	2	Config and status pages	2	3	config , status and polled pages	3	4	comprehensive URL logging	4
Web value	Description	UCI														
1	Actions invoked via web page	1														
2	Config and status pages	2														
3	config , status and polled pages	3														
4	comprehensive URL logging	4														

10.2.5. Time Synchronization

The router time must be synchronized using NTP. The router can act as both an NTP client and an NTP server. It is enabled as an NTP client by default and individual interfaces can be configured to respond to NTP requests.

Time Synchronization

NTP update interval

NTP server candidates

0	openwrt.pool.ntp.org	
1	openwrt.pool.ntp.org	
2	openwrt.pool.ntp.org	
3	openwrt.pool.ntp.org	

Max Round-Trip Time (sec)  *If NTP round-trip would take longer then this, it won't be regarded for calculation*

NTP Server Interface

NTP Server Stratum

NTP Source Combine Limit

The time synchronization section in system properties

Web Field/UCI/Package Option	Description				
Web: NTP update interval UCI: system.ntp.interval_hours Opt: interval_hours	Specifies interval of NTP requests in hours. Default value set to auto. <table border="1"> <tr> <td>Auto</td> <td></td> </tr> <tr> <td>Range</td> <td>auto; 1-23</td> </tr> </table>	Auto		Range	auto; 1-23
Auto					
Range	auto; 1-23				
Web: NTP server candidates UCI: system.ntp.server Opt: list server	Defines the list of NTP servers to poll the time from. If the list is empty, the built-in NTP daemon is not started. Multiple servers can be configured and are separated by a space if using UCI. By default all fields are set to 0.0.0.0.				
Web: Max Round-Tip Time (secs) UCI: system.ntp.max_ntp_roundtrip_sec Opt: max_ntp_roundtrip_sec	Defines the maximum time in seconds for an NTP poll. Any polls that take longer than this will be not be used for NTP calculation. <table border="1"> <tr> <td>2</td> <td>Two seconds</td> </tr> <tr> <td>Range</td> <td></td> </tr> </table>	2	Two seconds	Range	
2	Two seconds				
Range					
Web: NTP Server Interface UCI: system.ntp.listen Opt: listen	Defines a list of interfaces that respond to NTP requests. Interfaces should be delimited using space. Example: option listen 'LAN1 LAN2' <table border="1"> <tr> <td>Blank</td> <td>Do not respond to NTP requests</td> </tr> <tr> <td>Range</td> <td></td> </tr> </table>	Blank	Do not respond to NTP requests	Range	
Blank	Do not respond to NTP requests				
Range					
Web: NTP Server Stratum UCI: system.ntp.stratum Opt: stratum	Defines how far this NTP server is from the reference clock. For example, an NTP server getting time directly from the reference clock will have a stratum of 1. In general, this should be left blank, which means that the router NTP server will derive the stratum from the NTP dialogue. <table border="1"> <tr> <td>Blank</td> <td>NTP derive stratum</td> </tr> <tr> <td>Range</td> <td></td> </tr> </table>	Blank	NTP derive stratum	Range	
Blank	NTP derive stratum				
Range					
Web: NTP Source Combine Limit UCI: system.ntp.combinelimit Opt: combinelimit	Defines whether to limit sources included in the combining algorithm. When <code>chrony</code> has multiple sources available for synchronization, it has to select one source as the synchronization source. The measured offsets and frequencies of the system clock relative to the other sources, however, can be combined with the selected source to improve the accuracy of the system clock. The <code>combinelimit</code> directive limits which sources are included in the combining algorithm. Their synchronization distance has to be shorter than the distance of the selected source multiplied by the value of the limit. Also, their measured frequencies have to be close to the frequency of the selected source. <table border="1"> <tr> <td>3</td> <td></td> </tr> <tr> <td>Range</td> <td></td> </tr> </table>	3		Range	
3					
Range					

10.2.6. Console Login Banner

To configure a message that is displayed after login via SSH, telnet or console, in the top menu, select **System -> Administration**. Navigate to the Console login banner section.

Console login banner

Here you can specify the banner that is shown prior to logins

This is a test banner

The console login banner in system section

Web Field/UCI/Package Option	Description
Web: Console login banner UCI: system.main.banner list: banner	Defines a login banner that is displayed after log in via SSH, telnet or console

10.2.7. System Reboot

The router can be configured to reboot immediately, or scheduled to reboot a configured time in the future.

In the top menu, select **System -> Reboot**. The System page appears. Ensure you have saved all your configuration changes before you reboot.

The system settings reboot page

Check the **Reboot now** check box and then click **Reboot**.

10.3. System Settings Using Command Line

System settings are configured under the system package `/etc/config/system`. There are several configuration sections.

Section	Description
system	General system configuration options
timeserver	Router time and NTP configuration options
syslog_filter	Advanced filter rules (see Advanced filter section)

10.3.1. System Settings Using UCI

```
root@VA_router:~# uci show system
system.main=system
system.main.hostname=VA_router
system.main.timezone=UTC
system.main.log_ip=1.1.1.1
system.main.log_port=514
system.main.remoteloglevel=8
system.main.log_file=/root/syslog.messages
system.main.log_size=400
system.main.log_type=file
system.main.log_file_count=3
system.main.conloglevel=8
system.main.cronloglevel=8
system.main.banner=This is a test banner system.ntp.interval_hours=auto
system.ntp.server=0.VA_router.pool.ntp.org 10.10.10.10
system.ntp.combinelimit=3
```

System Settings Using Package Options

```
root@VA_router:~# uci export system package 'system'
config 'system' 'main'
option 'hostname' "VA_router"
option 'timezone' "UTC"
option 'log_ip' "1.1.1.1"
option 'log_port' "514"
option remoteloglevel '8'
option log_file '/root/syslog.messages'
option log_size '400'
option log_type 'file'
option log_file_count '3'
option time_save_interval_min "10"
option conloglevel '8'
option cronloglevel '8'
list banner `This is a test banner`
config 'timeserver' 'ntp'
option interval_hours 'auto'
list server "0.VA_router.pool.ntp.org"
list server '10.10.10.10'
option listen 'LAN1 LAN2' option combinelimit '3'
```

10.4. System Diagnostics

System log messages

System log messages comprise of a date, source facility, hostname, severity and message description in the form tag: message.

Facility	Description
auth	Authorisation/security
authpriv	Authorisation (private)
cron	Scheduled jobs
daemon	Background daemons
kern	Kernel messages
local0	hotplug scripts
security	Same as auth
syslog	Internal syslog events
user	General user-mode application messages

Event severity list

Level	Name	Description
0	emerg	System is unusable
1	alert	Immediate action required
2	crit	Critical conditions
3	error	Error conditions
4	warning	Warning conditions
5	notice	Normal but significant
6	info	Informational
7	debug	Debug-level messages
-	none	No priority

10.4.1. System Log Messages In RAM

By default, system log messages are stored in the system log in RAM. To view the system log in RAM, enter:

```
root@VA_router:~# logread
```

Shows the log.

```
root@VA_router:~# logread |tail
```

Shows end of the log.

```
root@VA_router:~# logread | more
```

Shows the log page by page.

```
root@VA_router:~# logread -f
```

Shows the log on an ongoing basis. To stop this option, press **ctrl-c**.

```
root@VA_router:~# logread -f &
```

Shows the log on an ongoing basis while in the background. This allows you to run other commands while still tracing the event logs. To stop this option, type **fg** to view the current jobs, then press **ctrl-c** to kill those jobs.

10.4.2. System Log Messages In Flash

Since logread is limited by memory size and does not survive a reset, it is beneficial to write system messages to flash memory. To do this, modify the system config under the system package.

Set the options **'log_file'**, **'log_size'**, **'log_type'** and **'log_file_count'** as shown below:

```
root@VA_router:~# uci export system package system
config system 'main'
option hostname 'VA_router' option zonename 'UTC' option timezone 'GMT0' option conloglevel '8'
option cronloglevel '8'
option time_save_interval_hour '10' option log_hostname '%serial' option log_ip '1.1.1.1'
option log_port '514'
option log_file '/root/syslog.messages' option log_size '400'
option log_type 'file'
option log_file_count '3'
```

The above commands will take effect after a reboot, or by running the console command:

```
root@VA_router:~# /etc/init.d/syslogd restart
```

```
root@VA_router:~# cat /root/syslog.messages
```

Shows all the system events stored in flash.

```
root@VA_router:~# tail /root/syslog.messages
```

Shows end of the events stored flash.

```
root@VA_router:~# tail -f /root/syslog.messages &
```

Shows the log on an ongoing basis. To stop this option, press **ctrl-c**.

10.4.3. Kernel Messages

To view kernel messages, enter `dmesg`

```
root@VA_router:~# dmesg
[ 0.000000] Linux version 3.10.12 (info@virtualaccess.com) (gcc version 4.8.1 20130401 (prerelease) (Linaro GCC 4.8-2013.04) )
#130 PREEMPT 1970-
01-01T00:00:00Z
```

```
[ 0.000000] SoC: xRX330 rev 1.1
[ 0.000000] bootconsole [early0] enabled
[ 0.000000] CPU0 revision is: 00019556 (MIPS 34Kc)
[ 0.000000] adding memory size:267386880 from DT
[ 0.000000] MIPS: machine is Virtual Access GW6600V series [ 0.000000] Determined physical RAM map:
[ 0.000000] memory: 0ff00000 @ 00000000 (usable) [ 0.000000] User-defined physical RAM map:
[ 0.000000] memory: 07200000 @ 00000000 (usable)
```



NOTE

Kernel messages are also copied to the main system log by default.

10.4.4. Syslog Process

To check the syslog process is running correctly, enter `pgrep -fl syslogd`

```
root@VA_router:~# pgrep -fl syslogd
5409 /sbin/syslogd -h VARouter -L -R 192.168.14.202:514 -l 7 -r 8 -s 400 -O
/root/syslog.messages -b 3 -C64 -R localhost:2048
```

Changes to the syslog configuration will take effect with a restart of syslogd

```
root@VA_router:~# /etc/init.d/syslogd restart
```

10.4.5. NTP Process

To check the NTP process is running correctly, enter `pgrep -fl chrony`

```
root@VA_router:~# pgrep -fl chrony
2553 /usr/sbin/chronyd -f /etc/chrony.conf
```

Changes to the NTP configuration will take effect with a restart of chrony

```
root@VA_router:~# /etc/init.d/chrony restart
```

10.5. Advanced Filtering Of Syslog Messages

Syslog messages can be filtered against a series of rules that are checked for each message generated. If a match is found, then the specified action is taken. If no match occurs, then the default action is taken, as defined in the main system logging settings.

A message may match multiple filters. They are processed in the order listed. For example, you may wish to record authorisation messages in the main system log, but also make a copy in a separate authorisation log which can span a much longer period of time.

By default, all matching filters will be applied to each message. However, you can mark a filter to indicate that after it matches, no further filter processing should take place.

The filter rules are defined in a free-form text list in the `syslog_filter` configuration section. There are two section types, one for messages to be stored locally, and one for messages delivered remotely.

Configuring advanced filters on the web interface is not currently supported; they must be edited using the command line interface.

10.5.1. Advanced Filtering Using Command Line

Filters are defined in the `syslog_filter` configuration section of the system package. A set of filters can be either local or remote.

- All messages are matched against both local and remote filter rules, if configured.
- Each local filter matched is executed; if there is no match, then the default local logging action applies.
- Any remote filter matched is executed; if there is no match, then the default remote logging action applies.

```
root@VA_router:~# uci export system
package system

config syslog_filter 'local'
list text "...line 1..."
list text "...line 2..."
list text "...line 3..."

config syslog_filter 'remote'
list text "...line 1..."
list text "...line 2..."
list text "...line 3..."
```

Lines defined here are copied to the router runtime file **/var/conf/syslog.conf** which may be reviewed to determine current rules in use.

10.5.2. Filter Definitions

Each filter ruleset is a series of lines. Each line can be:

- A filter pattern, of the form `facility.[op]severity(pattern) target [~]`
- A blank line, or comment line, starting with hash (**#**).

If a message does not match any of the filter lines for a destination, local or remote, the default action for that destination is taken.

The sections of a filter pattern break down as shown in the following table.

Section	Description																		
facility	<p>Any keyword or comma-separated list of keywords from the source facility list. See the Source Facilities table in section 6.5.1.1.</p> <p>Use the wildcard '*' to match all facilities.</p>																		
severity	<p>Any keyword from the event severity list (see Event Severity table above). The rule will match all severities more urgent if the message severity level is at least as urgent as this.</p> <p>Use the wildcard '*' to match all facilities.</p>																		
op	<p>Defines an optional severity condition.</p> <table border="1"> <tr> <td>(empty)</td> <td>match listed severity, and also anything more severe</td> </tr> <tr> <td>!</td> <td>match on less urgent severities than that listed</td> </tr> <tr> <td>=</td> <td>severity must match exactly</td> </tr> <tr> <td>! =</td> <td>match any severity other than the listed severity</td> </tr> </table> <p>Examples:</p> <p>*.debug matches all messages of debug severity and greater (i.e. debug, info, warning, etc)</p> <p>*.=debug matches all debug messages.</p>	(empty)	match listed severity, and also anything more severe	!	match on less urgent severities than that listed	=	severity must match exactly	! =	match any severity other than the listed severity										
(empty)	match listed severity, and also anything more severe																		
!	match on less urgent severities than that listed																		
=	severity must match exactly																		
! =	match any severity other than the listed severity																		
pattern	<p>Defines an optional pattern to match against the message text. The pattern is used to restrict the number of log messages matching this filter.</p> <p>The pattern syntax is a simple case-insensitive regular expression, using these characters:</p> <table border="1"> <tr> <td>*</td> <td>Matches zero or more characters.</td> </tr> <tr> <td>?</td> <td>Matches any single character (use this for spaces).</td> </tr> <tr> <td>!</td> <td>Matches anything not matching the following pattern.</td> </tr> <tr> <td>^</td> <td>Matches the start of a message.</td> </tr> <tr> <td>\$</td> <td>Matches the end of a message.</td> </tr> </table> <p>Examples:</p> <table border="1"> <tr> <td>(firewall:)</td> <td>Match any message containing the string 'firewall.'</td> </tr> <tr> <td>(up*eth1)</td> <td>Match any UP message referencing eth1</td> </tr> <tr> <td>(!mobile)</td> <td>Match only messages that do not include the string 'mobile'</td> </tr> <tr> <td>(^mobile)</td> <td>Match only messages beginning with the string 'mobile'</td> </tr> </table>	*	Matches zero or more characters.	?	Matches any single character (use this for spaces).	!	Matches anything not matching the following pattern.	^	Matches the start of a message.	\$	Matches the end of a message.	(firewall:)	Match any message containing the string 'firewall.'	(up*eth1)	Match any UP message referencing eth1	(!mobile)	Match only messages that do not include the string 'mobile'	(^mobile)	Match only messages beginning with the string 'mobile'
*	Matches zero or more characters.																		
?	Matches any single character (use this for spaces).																		
!	Matches anything not matching the following pattern.																		
^	Matches the start of a message.																		
\$	Matches the end of a message.																		
(firewall:)	Match any message containing the string 'firewall.'																		
(up*eth1)	Match any UP message referencing eth1																		
(!mobile)	Match only messages that do not include the string 'mobile'																		
(^mobile)	Match only messages beginning with the string 'mobile'																		
target	<p>Defines what to do with the log message when a match occurs. It is optional for remote filters. It can be the name of a disk file, or one of the special target keywords listed below.</p> <table border="1"> <tr> <td>default</td> <td>Do whatever the default action is, as if not the filter rule is matched.</td> </tr> <tr> <td>ignore</td> <td>Never log this message (useful for remote filtering).</td> </tr> <tr> <td>console</td> <td>Log this message to the console. To view the console use <code>cat/procd/conlog</code></td> </tr> <tr> <td>mem</td> <td>Log this message to the memory buffer (logread), if configured.</td> </tr> </table> <p>Note: logread is not stored through reboot.</p>	default	Do whatever the default action is, as if not the filter rule is matched.	ignore	Never log this message (useful for remote filtering).	console	Log this message to the console. To view the console use <code>cat/procd/conlog</code>	mem	Log this message to the memory buffer (logread), if configured.										
default	Do whatever the default action is, as if not the filter rule is matched.																		
ignore	Never log this message (useful for remote filtering).																		
console	Log this message to the console. To view the console use <code>cat/procd/conlog</code>																		
mem	Log this message to the memory buffer (logread), if configured.																		
~	<p>Optional flag to indicate no further filters should be checked, if this filter matches. This prevents later filters from acting on the same message. For convenience this is automatically implied when a target of ignore is used. A space must be present before the ~ character.</p> <table border="1"> <tr> <td>~</td> <td>No further filters should be checked after a match.</td> </tr> <tr> <td>(empty)</td> <td>Continue checking other filters after a match.</td> </tr> </table>	~	No further filters should be checked after a match.	(empty)	Continue checking other filters after a match.														
~	No further filters should be checked after a match.																		
(empty)	Continue checking other filters after a match.																		

Filter Examples

Example 1

Log all debug messages to memory buffer. Do not log anywhere else locally.

Log all authorisation facility messages to filepath 'var/log/auth'. Do not log anywhere else locally.

Log all ipsec messages to filepath 'va/log/ipsec'. Do not log anywhere else locally.

For everything else, apply default local logging.

No remote filter rules defined, so apply default remote logging to all messages.

```
config syslog_filter 'local'
list text '.*=debug mem ~'
list text 'auth,authpriv.* /var/log/auth ~'
list text '.*(ipsec) /var/log/ipsec ~'
```

Example 2

As Example 1 but in addition to specified local files, copy auth, authpriv and ipsec to local default log.

```
config syslog_filter 'local'
list text '.*=debug mem ~'
list text 'auth,authpriv.* /var/log/auth'
list text '.*(ipsec) /var/log/ipsec'
list text '.*.* default'
```

Example 3

As in Example 2, except **do not** send any auth or auth priv messages remotely.

```
config syslog_filter 'local'
list text '.*=debug mem ~'
list text 'auth,authpriv.* /var/log/auth'
list text '.*(ipsec) /var/log/ipsec'
list text '.*.* default' config syslog_filter 'remote'
```

Example 4

As in Example 3, except only send auth or auth priv messages remotely.

```
config syslog_filter 'local'
list text '.*=debug mem ~'
list text 'auth,authpriv.* /var/log/auth'
list text '.*(ipsec) /var/log/ipsec'
list text '.*.* default' config syslog_filter 'remote'
list text 'auth,authpriv.* ~'
list text '.*.* ignore'
```

11. Configuring An Ethernet Interface

This chapter describes how to configure an Ethernet interface including configuring the interface as a DHCP server, adding the interface to a firewall zone, mapping the physical switch ports and defining loopback interface.

Configuration Packages Used

Package	Sections
Network	interface
	route
	va_switch
	alias
firewall	zone
dhcp	dhcp

11.1. Configuring An Ethernet Interface Using The Web Interface

To create and edit interfaces via the web interface, in the top menu, click **Network -> Interfaces**. The Interfaces overview page appears.

The screenshot shows the 'Interfaces' overview page in the Merlin 4400 Management Guide. The page has a top navigation bar with 'Status', 'System', 'Services', 'Network', and 'Logout'. A dropdown menu is open under 'Network', listing options like 'Interfaces', 'DHCP and DNS', 'Hostnames', 'Static Routes', 'Diagnostics', 'Firewall', 'Port-based VLAN', 'ADSL', 'RF', 'Multi-WAN', 'VRRP', 'BGP', 'OSPF', and 'DHCP Forwarder (BRUPF)'. The main content area is titled 'Interfaces' and 'Interface Overview'. It contains a table with the following data:

Network	Status	Actions
3G_ST_V00A 3g-st_v1_node	RX: 0.00 B (0 Pkts) TX: 0.00 B (0 Pkts)	Connect Stop Edit Delete
LAN eth0	Uptime: 0h 15m 1s MAC Address: 00 RX: 2.47 MB (106) TX: 495.73 KB (13) IPv4: 10.1.9.88/16	Connect Stop Edit Delete
LAN1 eth1	Uptime: 0h 0m 5s MAC Address: 00 RX: 0.00 B (0 Pkts) TX: 0.00 B (0 Pkts)	Connect Stop Edit Delete
LOOPBACK lo	Uptime: 0h 0m 0s MAC Address: 00:00:00:00:00:00 RX: 0.00 B (0 Pkts) TX: 0.00 B (0 Pkts) IPv6: 0:0:0:0:0:0:1:125	Connect Stop Edit Delete
WAN 3g-wan	RX: 0.00 B (0 Pkts) TX: 0.00 B (0 Pkts)	Connect Stop Edit Delete
WAN1 3g-wan1	RX: 0.00 B (0 Pkts) TX: 0.00 B (0 Pkts)	Connect Stop Edit Delete
WAN2 3g-wan2	RX: 0.00 B (0 Pkts) TX: 0.00 B (0 Pkts)	Connect Stop Edit Delete

Below the table is an 'Add new interface...' button. The 'Port Map' section has a description: 'Map device ports to ethernet interfaces. Ports are marked with capital letters starting with 'A'. Type in space separated port numbers to fields below'. It has two input fields: 'eth0' with 'A' and 'eth1' with 'B'. The 'ATM Bridges' section has a description: 'ATM bridges expose encapsulated ethernet in AAL5 connections as virtual Linux network interfaces which can be used in conjunction with DHCP or PPP to dial into the provider network. This section contains no values yet.' and an 'Add' button. At the bottom right, there are 'Save & Apply', 'Save', and 'Reset' buttons.

The interfaces overview page

There are three sections in the Interfaces page.

Section	Description
Interface Overview	Shows existing interfaces and their status. You can create new, and edit existing interfaces here.
Port Map	In this section you can map device ports to Ethernet interfaces. Ports are marked with capital letters starting with 'A'. Type in space-separated port character in the port map fields.
ATM Bridges	ATM bridges expose encapsulated Ethernet in AAL5 connections as virtual Linux network interfaces, which can be used in conjunction with DHCP or PPP to dial into the provider network.

11.1.1. Interface Overview: Editing An Existing Interface

To edit an existing interface, from the interface tabs at the top of the page, select the interface you wish to configure. Alternatively, click **Edit** in the interface's row.

11.1.2. Interface Overview: Creating A New Interface

To create a new interface, in the Interface Overview section, click **Add new interface**. The Create Interface page appears.

The create interface page

Web Field/UCI/Package Option	Description																																										
Web: Name of the new interface UCI: network.<if name> Opt: config interface	Assigns a logical name to the interface. The network interface section will assign this name (<if name>). Type the name of the new interface. Allowed characters are A-Z, a-z, 0-9 and _																																										
Web: Protocol of the new interface UCI: network.<if name>.proto Opt: proto	Specifies what protocol the interface will operate on. Select Static . <table border="1"> <thead> <tr> <th>Web</th> <th>Description</th> <th>UCI</th> </tr> </thead> <tbody> <tr> <td>Static</td> <td>Static configuration with fixed address and netmask</td> <td>static</td> </tr> <tr> <td>DHCP Client</td> <td>Address and netmask are assigned by DHCP.</td> <td>dhcp</td> </tr> <tr> <td>Unmanaged</td> <td>Unspecified</td> <td>none</td> </tr> <tr> <td>IPv6-in-IPv4 (RFC4213)</td> <td>Used with tunnel brokers.</td> <td></td> </tr> <tr> <td>GRE</td> <td>Generic Routing Encapsulation protocol</td> <td>gre</td> </tr> <tr> <td>IOT</td> <td>IOT</td> <td>iot</td> </tr> <tr> <td>L2TP</td> <td>Layer 2 Tunnelling Protocol</td> <td>i2tp</td> </tr> <tr> <td>L2TPv3</td> <td>L2TPv3 Tunnelling Protocol</td> <td>i2tpv3</td> </tr> <tr> <td>PPP</td> <td>Point to Point Tunnelling protocol</td> <td>ppp</td> </tr> <tr> <td>PPPoE</td> <td>PPP over Ethernet</td> <td>pppoe</td> </tr> <tr> <td>PPPoATM</td> <td>PPP over ATM</td> <td>pppoa</td> </tr> <tr> <td>LTE/UMTS/GPRS/EV-DO</td> <td>CDMA, UMTS, or GPRS connection using an AT-style 3G modem</td> <td>3g</td> </tr> <tr> <td>PPP (PSTN-Modem)</td> <td>PPP v90 modem</td> <td>pppmodem</td> </tr> </tbody> </table>	Web	Description	UCI	Static	Static configuration with fixed address and netmask	static	DHCP Client	Address and netmask are assigned by DHCP.	dhcp	Unmanaged	Unspecified	none	IPv6-in-IPv4 (RFC4213)	Used with tunnel brokers.		GRE	Generic Routing Encapsulation protocol	gre	IOT	IOT	iot	L2TP	Layer 2 Tunnelling Protocol	i2tp	L2TPv3	L2TPv3 Tunnelling Protocol	i2tpv3	PPP	Point to Point Tunnelling protocol	ppp	PPPoE	PPP over Ethernet	pppoe	PPPoATM	PPP over ATM	pppoa	LTE/UMTS/GPRS/EV-DO	CDMA, UMTS, or GPRS connection using an AT-style 3G modem	3g	PPP (PSTN-Modem)	PPP v90 modem	pppmodem
Web	Description	UCI																																									
Static	Static configuration with fixed address and netmask	static																																									
DHCP Client	Address and netmask are assigned by DHCP.	dhcp																																									
Unmanaged	Unspecified	none																																									
IPv6-in-IPv4 (RFC4213)	Used with tunnel brokers.																																										
GRE	Generic Routing Encapsulation protocol	gre																																									
IOT	IOT	iot																																									
L2TP	Layer 2 Tunnelling Protocol	i2tp																																									
L2TPv3	L2TPv3 Tunnelling Protocol	i2tpv3																																									
PPP	Point to Point Tunnelling protocol	ppp																																									
PPPoE	PPP over Ethernet	pppoe																																									
PPPoATM	PPP over ATM	pppoa																																									
LTE/UMTS/GPRS/EV-DO	CDMA, UMTS, or GPRS connection using an AT-style 3G modem	3g																																									
PPP (PSTN-Modem)	PPP v90 modem	pppmodem																																									
Web: Create a bridge over multiple interfaces UCI: network.<if name>.type Opt: type	If you select this option, then the new logical interface created will act as a bridging interface between the chosen existing physical interfaces. <table border="1"> <tbody> <tr> <td>Empty</td> <td></td> </tr> <tr> <td>Bridge</td> <td>Configures a bridge over multiple interfaces</td> </tr> </tbody> </table>	Empty		Bridge	Configures a bridge over multiple interfaces																																						
Empty																																											
Bridge	Configures a bridge over multiple interfaces																																										
Web: Cover the following interface UCI: network.<if name>.ifname Opt: ifname	Physical interface name to assign to this logical interface. If creating a bridge over multiple interfaces select two interfaces to bridge. When using UCI the interface names should be separated by a space e.g. option ifname 'eth2 eth3'																																										

Click **Submit**. The Interface configuration page appears. There are three sections:

Section	Description
Common Configuration	Configure the interface settings such as protocol, IP address, gateway, netmask, custom DNS servers, MTU and firewall configuration.
IP-Aliases	Assigning multiple IP addresses to the interface.
DHCP Server	Configuring DHCP server settings for this interface.

11.1.3. Interface Overview: Common Configuration

The common configuration section has four sub-sections:

Section	Description
General Setup	Configure the basic interface settings such as protocol, IP address, gateway, netmask, custom DNS servers.
Advanced Settings	'Bring up on boot', 'Monitor interface state', Override MAC address, Override MTU and 'Use gateway metric'.
Physical Settings	Bridge interfaces, VLAN PCP to SKB priority mapping.
Firewall settings	Assign a firewall zone to the interface.

Common Configuration: General Setup

Common Configuration

General Setup Advanced Settings Physical Settings Firewall Settings

Status  **MAC Address:** 00:E0:C8:D3:18:20
RX: 0.00 B (0 Pkts.)
TX: 0.00 B (0 Pkts.)

Protocol

IPv4 address

IPv4 netmask

IPv4 gateway

IPv4 broadcast

Use custom DNS servers 

Accept router advertisements

Send router solicitations

IPv6 address

IPv6 gateway

The Ethernet connection common configuration settings page

Web Field/UCI/Package Option	Description																																																
Web: Status	Shows the current status of the interface.																																																
Web: Protocol UCI: network.<if name>.proto Opt: proto	<p>Protocol type. The interface protocol may be one of the options shown below. The protocol selected in the previous step will be displayed as default but can be changed if required.</p> <table border="1"> <thead> <tr> <th>Web</th> <th>Description</th> <th>UCI</th> </tr> </thead> <tbody> <tr> <td>Static</td> <td>Static configuration with fixed address and netmask.</td> <td>static</td> </tr> <tr> <td>DHCP Client</td> <td>Address and netmask are assigned by DHCP.</td> <td>dhcp</td> </tr> <tr> <td>Unmanaged</td> <td>Unspecified</td> <td>none</td> </tr> <tr> <td>IPv6-in-IPv4 (RFC4213)</td> <td>Used with tunnel brokers.</td> <td></td> </tr> <tr> <td>IPv6-over-IPv4</td> <td>Stateless IPv6 over IPv4 transport.</td> <td></td> </tr> <tr> <td>GRE</td> <td>Generic Routing Encapsulation protocol</td> <td>gre</td> </tr> <tr> <td>IOT</td> <td>IOT</td> <td>iot</td> </tr> <tr> <td>L2TP</td> <td>Layer 2 Tunnelling Protocol</td> <td>i2tp</td> </tr> <tr> <td>L2TPv3</td> <td>L2TPv3 Tunnelling Protocol</td> <td>i2tpv3</td> </tr> <tr> <td>PPP</td> <td>Point to Point protocol</td> <td>ppp</td> </tr> <tr> <td>PPtP</td> <td>Point to Point Tunnelling protocol</td> <td>pptp</td> </tr> <tr> <td>PPPoE</td> <td>PPP over Ethernet</td> <td>pppoe</td> </tr> <tr> <td>PPPoATM</td> <td>PPP over ATM</td> <td>pppoa</td> </tr> <tr> <td>LTE/UMTS/GPRS/EV-DO</td> <td>CDMA, UMTS or GPRS connection using an AT-style 3G modem</td> <td>3g</td> </tr> <tr> <td>PPP(PSTN-Modem)</td> <td>PPP v90 modem</td> <td>pppmodem</td> </tr> </tbody> </table>	Web	Description	UCI	Static	Static configuration with fixed address and netmask.	static	DHCP Client	Address and netmask are assigned by DHCP.	dhcp	Unmanaged	Unspecified	none	IPv6-in-IPv4 (RFC4213)	Used with tunnel brokers.		IPv6-over-IPv4	Stateless IPv6 over IPv4 transport.		GRE	Generic Routing Encapsulation protocol	gre	IOT	IOT	iot	L2TP	Layer 2 Tunnelling Protocol	i2tp	L2TPv3	L2TPv3 Tunnelling Protocol	i2tpv3	PPP	Point to Point protocol	ppp	PPtP	Point to Point Tunnelling protocol	pptp	PPPoE	PPP over Ethernet	pppoe	PPPoATM	PPP over ATM	pppoa	LTE/UMTS/GPRS/EV-DO	CDMA, UMTS or GPRS connection using an AT-style 3G modem	3g	PPP(PSTN-Modem)	PPP v90 modem	pppmodem
Web	Description	UCI																																															
Static	Static configuration with fixed address and netmask.	static																																															
DHCP Client	Address and netmask are assigned by DHCP.	dhcp																																															
Unmanaged	Unspecified	none																																															
IPv6-in-IPv4 (RFC4213)	Used with tunnel brokers.																																																
IPv6-over-IPv4	Stateless IPv6 over IPv4 transport.																																																
GRE	Generic Routing Encapsulation protocol	gre																																															
IOT	IOT	iot																																															
L2TP	Layer 2 Tunnelling Protocol	i2tp																																															
L2TPv3	L2TPv3 Tunnelling Protocol	i2tpv3																																															
PPP	Point to Point protocol	ppp																																															
PPtP	Point to Point Tunnelling protocol	pptp																																															
PPPoE	PPP over Ethernet	pppoe																																															
PPPoATM	PPP over ATM	pppoa																																															
LTE/UMTS/GPRS/EV-DO	CDMA, UMTS or GPRS connection using an AT-style 3G modem	3g																																															
PPP(PSTN-Modem)	PPP v90 modem	pppmodem																																															
Web: IPv4 address UCI: network.<if name>.ipaddr Opt: ipaddr	The IPv4 address of the interface. This is optional if an IPv6 address is provided.																																																
Web: IPv4 netmask UCI: network.<if name>.netmask Opt: netmask	Subnet mask to be applied to the IP address of this interface.																																																
Web: IPv4 gateway UCI: network.<if name>.gateway Opt: gateway	IPv4 default gateway to assign to this interface (optional).																																																
Web: IPv4 broadcast UCI: network.<if name>.broadcast Opt: broadcast	Broadcast address. This is automatically generated if no broadcast address is specified.																																																
Web: Use custom DNS servers UCI: network.<if name>.dns Opt: list dns	List of DNS server IP addresses (optional). Multiple DNS Servers are separated by a space if using UCI.																																																
Web: Accept router advertisements UCI: network.<if name>.accept_ra Opt: accept_ra	Specifies whether to accept IPv6 Router Advertisements on this interface (optional). Note: default is 1 if protocol is set to DHCP, otherwise defaults to 0 .																																																
Web: Send router solicitations UCI: network.<if name>.send_rs Opt: send_rs	Specifies whether to send Router Solicitations on this interface (optional). Note: defaults to 1 for static protocol, otherwise defaults to 0 .																																																
Web: IPv6 address UCI: network.<if name>.ip6addr	The IPv6 IP address of the interface. Optional if an IPv4 address is provided. CIDR notation for the IPv6 address is required.																																																

Web Field/UCI/Package Option	Description
Opt: ip6addr	
Web: IPv6 gateway	Assign given IPv6 default gateway to this interface (optional).
UCI: network.<if name>.ip6gw	
Opt: ip6gw	

Common Configuration: Advanced Settings

Status ▾ System ▾ Services ▾ Network ▾ Logout

Common Configuration

General Setup
Advanced Settings
Physical Settings
Firewall Settings

Bring up on boot

Monitor interface state ⓘ *This interface state would be reported to VA Monitor via [keep-alive](#)*

Use broadcast flag ⓘ *Required for certain ISPs, e.g. Charter with DOCSIS 3*

Use default gateway ⓘ *If unchecked, no default route is configured*

Use DNS servers advertised by peer ⓘ *If unchecked, the advertised DNS server addresses are ignored*

Use gateway metric

Client ID to send when requesting DHCP

Vendor Class to send when requesting DHCP

Override MAC address

Override MTU

The Ethernet connection advanced settings page

Web Field/UCI/Package Option	Description										
Web: Bring up on boot UCI: network.<if name>.auto Opt: auto	Enables the interface to connect automatically on boot up. <table border="1"> <tr> <td>0</td> <td>Disabled</td> </tr> <tr> <td>1</td> <td>Enabled</td> </tr> </table>	0	Disabled	1	Enabled						
0	Disabled										
1	Enabled										
Web: Monitor interface state UCI: network.<if name>.monitored Opt: monitored	Enabled if status of interface is presented on Monitoring platform. <table border="1"> <tr> <td>0</td> <td>Disabled</td> </tr> <tr> <td>1</td> <td>Enabled</td> </tr> </table>	0	Disabled	1	Enabled						
0	Disabled										
1	Enabled										
Web: Override MAC address UCI: network.<if name>.macaddr Opt: macaddr	Override the MAC address assigned to this interface. Must be in the form: hh:hh:hh:hh:hh:hh, where h is a hexadecimal number.										
Web: Override MTU UCI: network.<if name>.mtu Opt: mtu	Defines the value to override the default MTU on this interface. <table border="1"> <tr> <td>1500</td> <td>1500 bytes</td> </tr> </table>	1500	1500 bytes								
1500	1500 bytes										
Web: Use gateway metric UCI: network.<if name>.metric Opt: metric	Specifies the default route metric to use for this interface (optional). <table border="1"> <tr> <td>0</td> <td></td> </tr> <tr> <td>Range</td> <td></td> </tr> </table>	0		Range							
0											
Range											
Web: Dependant Interfaces UCI: network.[..x.].dependants Opt: dependants	Lists interfaces that are dependant on this parent interface. Dependant interfaces will go down when parent interface is down and will start or restart when parent interface starts. Separate multiple interfaces by a space when using UCI Example: options dependants 'PPPADSL MOBILE' This replaces the following previous options in child interfaces. <table border="1"> <tr> <td>gre</td> <td>option local_interface</td> </tr> <tr> <td>lt2p</td> <td>option src_ipaddr</td> </tr> <tr> <td>iot</td> <td>option wan1 wan2</td> </tr> <tr> <td>6in4</td> <td>option ipaddr</td> </tr> <tr> <td>6t04</td> <td>option ipaddr</td> </tr> </table>	gre	option local_interface	lt2p	option src_ipaddr	iot	option wan1 wan2	6in4	option ipaddr	6t04	option ipaddr
gre	option local_interface										
lt2p	option src_ipaddr										
iot	option wan1 wan2										
6in4	option ipaddr										
6t04	option ipaddr										
Web: SNMP Alias ifindex UCI: network.[..x.].snmp_alias_ifindex Opt: snmp_alias_ifindex	Defines a static SNMP interface alias index for this interface, that can be polled via the SNMP interface index (snmp_alias_ifindex+1000). See 'Configuring SNMP' section for more information. <table border="1"> <tr> <td>Blank</td> <td>No SNMP interface alias index</td> </tr> <tr> <td>Range</td> <td>0 - 4294966295</td> </tr> </table>	Blank	No SNMP interface alias index	Range	0 - 4294966295						
Blank	No SNMP interface alias index										
Range	0 - 4294966295										

Common Configuration: Physical Settings

Status ▾ System ▾ Services ▾ Network ▾ Logout

Common Configuration

General Setup Advanced Settings Physical Settings Firewall Settings

Bridge interfaces *creates a bridge over specified interface(s)*

VLAN PCP to skb->priority mapping
 Space separated list of <pcp>:<priority>

skb->priority to VLAN PCP mapping

Interface

- Ethernet Adapter: "3G" (3G)
- Ethernet Adapter: "ADSL" (ADSL)
- Ethernet Adapter: "eth0"
- Ethernet Adapter: "eth1" (lan1)
- Ethernet Adapter: "eth2"
- Ethernet Adapter: "eth3"
- Ethernet Adapter: "lo" (loopback)
- Ethernet Adapter: "teq10"
- Ethernet Adapter: "tun10"
- Ethernet Adapter: "usb0"
- Wireless Network: Master "GW6630W_VA" (lan)
- Custom Interface:

The common configuration physical settings page

Web Field/UCI/Package Option	Description				
Web: Bridge interfaces UCI: network.<if name>.type Opt: type	Sets the interface to bridge over a specified interface(s). The physical interfaces can be selected from the list and are defined in network.<if name>.ifname. <table border="1"> <tr> <td>Empty</td> <td></td> </tr> <tr> <td>Bridge</td> <td>Configures a bridge over multiple interfaces.</td> </tr> </table>	Empty		Bridge	Configures a bridge over multiple interfaces.
Empty					
Bridge	Configures a bridge over multiple interfaces.				
Web: Enable STP UCI: network.<if name>.stp Opt: stp	Enable Spanning Tree Protocol. This option is only available when the Bridge Interfaces option is selected. <table border="1"> <tr> <td>0</td> <td>Disabled</td> </tr> <tr> <td>1</td> <td>Enabled</td> </tr> </table>	0	Disabled	1	Enabled
0	Disabled				
1	Enabled				
Web: VLAN PCP to skb>priority mapping UCI: network.<if name>.vlan_qos_map_ingress Opt: list vlan_qos_map_ingress	VLAN priority code point to socket buffer mapping. Multiple priority mappings are entered with a space between them when using UCI. Example: network.<if name>. vlan_qos_map_ingress =1:2 2:1				
Web: skb priority to >VLAN PCP mapping UCI: network.<if name>.vlan_qos_map_egress Opt: list vlan_qos_map_egress	Socket buffer to VLAN priority code point mapping. Multiple priority mappings are entered with a space between them when using UCI. Example: network.<if name>. vlan_qos_map_egress =1:2 2:1				
Web: Interface UCI: network.<if name>.ifname Opt: ifname	Physical interface to assign the logical interface to. If mapping multiple interfaces for bridging the interface names are separated by a space when using UCI and package options. Example: option ifname 'eth2 eth3' or network.<if name>.ifname=eth2 eth 3				

Loopback Interfaces

Loopback interfaces are defined in exactly the same way as Ethernet interfaces. For more information, read the section above.



NOTE

There is no software limitation as to how many loopback interfaces can exist on the router.

Common Configuration: Firewall Settings

Use this section to select the firewall zone you want to assign to this interface.

Select **unspecified** to remove the interface from the associated zone or fill out the create field to define a new zone and attach the interface to it.

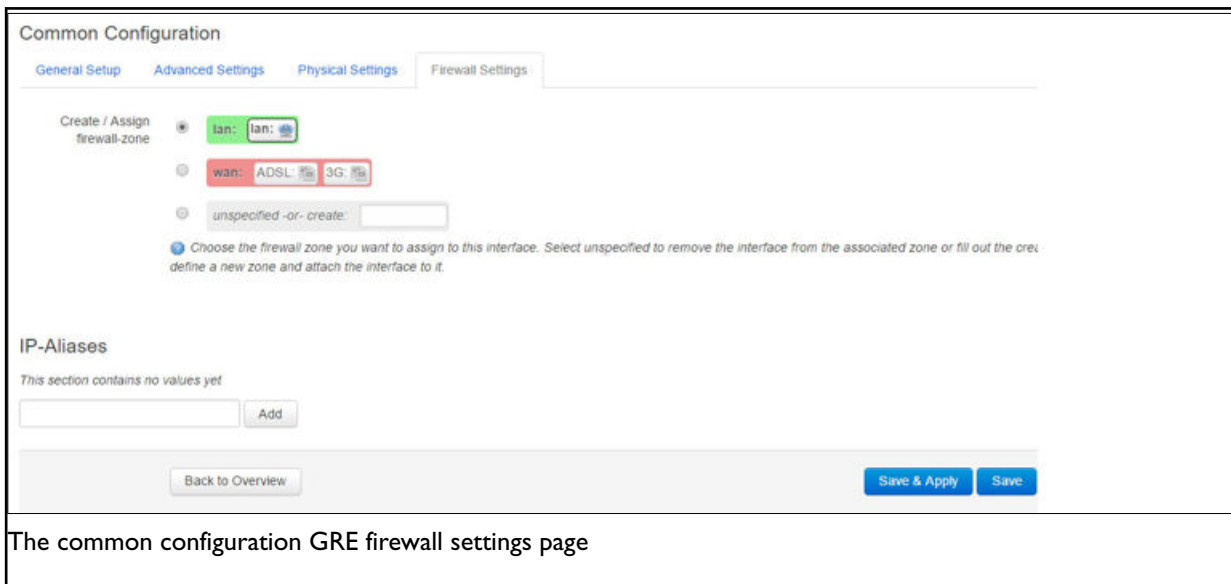

Common Configuration: Firewall Settings

Use this section to select the firewall zone you want to assign to this interface.

Select **unspecified** to remove the interface from the associated zone or fill out the create field to define a new zone and attach the interface to it.

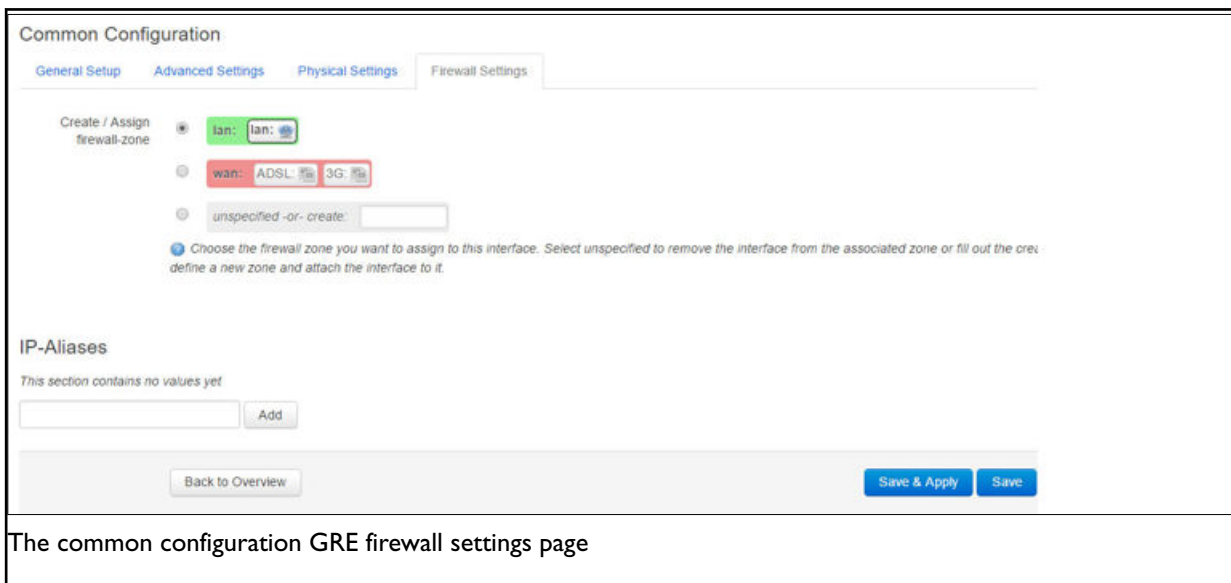

11.2. Interface Overview: IP-Aliases

IP-aliasing means associating more than one IP address to a network interface. You can assign multiple aliases.

IP-alias Packages

Package	Section
Network	alias

11.2.1. IP-Alias Using The Web

To use IP-aliases, enter a name for the alias and click **Add**. This name will be assigned to the alias section for this IP-alias. In this example, we use the name 'ethalias1'.

IP-Aliases

This section contains no values yet

The IP-Aliases section

Web Field/UCI/Package Option	Description
UCI: network.<alias name>=ifname Opt: config interface 'aliasname'	Assigns the alias name.
UCI: network.<alias name>.interface Opt: interface	This maps the IP-Alias to the interface.
UCI: network.<alias name>.proto Opt: proto	This maps the interface protocol to the alias.

After you have clicked **Add**, the IP-Aliases configuration options page appears.

The IP- Alias page is divided into two sub sections: general setup and advanced.

11.2.2. IP-Aliases: General Setup

IP-Aliases

ETHALIAS1

IPv4-Address

IPv4-Netmask

IPv4-Gateway

The IP-Aliases general setup page

Web Field/UCI/Package Option	Description
Web: IPv4-Address UCI: network.<alias name>.ipaddr Opt: ipaddr	Defines the IP address for the IP-alias.
Web: IPv4-Netmask UCI: network.<alias name>.netmask Opt: netmask	Defines the netmask for the IP-alias.
Web: IPv4-Gateway UCI: network.<alias name>.gateway Opt: gateway	Defines the gateway for the IP-alias.

11.2.3. IP-Aliases: Advanced Settings

IP-Aliases

ETHALIAS1

[General Setup](#) [Advanced Settings](#)

IPv4-Broadcast

DNS-Server

The IP-Aliases advanced settings section

Web Field/UCI/Package Option	Description
Web: IPv4-Broadcast UCI: network.<alias name>.bcast Opt: bcast	Defines the IP broadcast address for the IP-alias.
Web: DNS-Server UCI: network.<alias name>.dns Opt: dns	Defines the DNS server for the IP-alias.

11.3. Interface Overview: DHCP Server



NOTE

This option is only available for interfaces with a static IP address.

DHCP Server: Packages

Package	Sections
dhcp	dhcp

To assign a DHCP server to the interface, click **Setup DHCP Server**.



The DHCP server configuration options appear. The DHCP Server is divided into two sub-sections: General Setup and Advanced Settings.

11.3.1. DHCP Server: General Setup

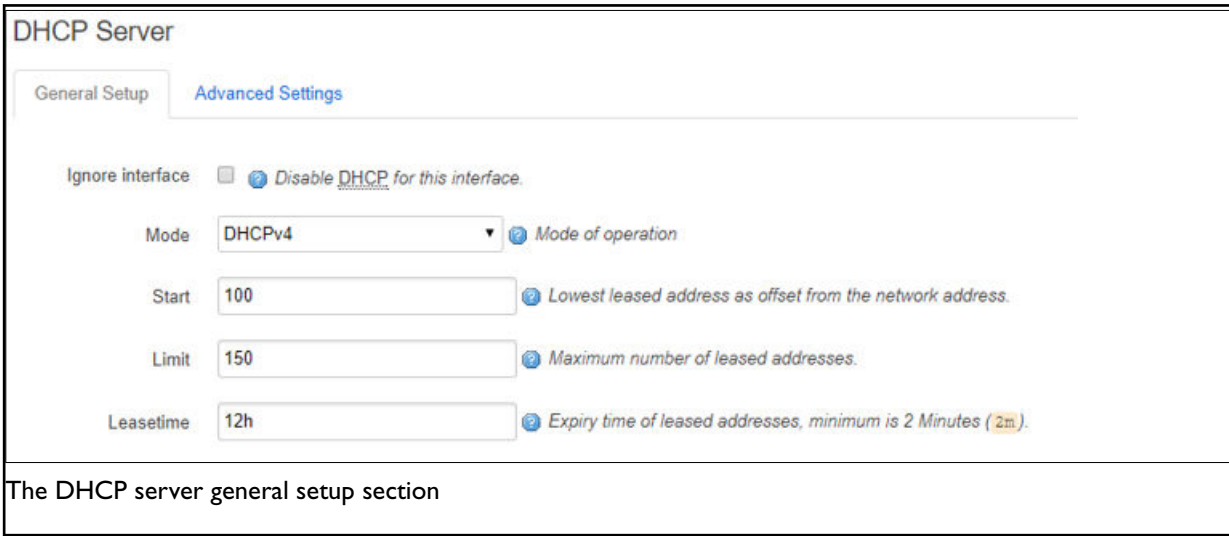

The DHCP server general setup section

Web Field/UCI/Package Option	Description															
Web: ignore interface UCI: dhcp@dhcp[x].ignore Opt: ignore	Defines whether the DHCP pool should be enabled for this interface. If not specified for the DHCP pool then default is disabled i.e. dhcp pool enabled. <table border="1"> <tr> <td>0</td> <td>Disabled.</td> </tr> <tr> <td>1</td> <td>Enabled.</td> </tr> </table>	0	Disabled.	1	Enabled.											
0	Disabled.															
1	Enabled.															
Web: Mode UCI: dhcp@dhcp[x].mode Opt: mode	Defines whether the DHCP pool should be enabled for this interface. If not specified for the DHCP pool then default is disabled i.e. dhcp pool enabled. <table border="1"> <thead> <tr> <th>Web</th> <th>Description</th> <th>UCI</th> </tr> </thead> <tbody> <tr> <td>DHCPv4</td> <td>DHCP for IPv4</td> <td>ipv4</td> </tr> <tr> <td>DHCPv6</td> <td>DHCP for IPv6</td> <td>ipv6_dhcp</td> </tr> <tr> <td>IPv6 Router Advertisements</td> <td>IPv6 RA</td> <td>ipv6_ra</td> </tr> <tr> <td>DHCPv6 Prefix Delegation</td> <td>DHCPv6 prefix delegation</td> <td>ipv6_pd</td> </tr> </tbody> </table>	Web	Description	UCI	DHCPv4	DHCP for IPv4	ipv4	DHCPv6	DHCP for IPv6	ipv6_dhcp	IPv6 Router Advertisements	IPv6 RA	ipv6_ra	DHCPv6 Prefix Delegation	DHCPv6 prefix delegation	ipv6_pd
Web	Description	UCI														
DHCPv4	DHCP for IPv4	ipv4														
DHCPv6	DHCP for IPv6	ipv6_dhcp														
IPv6 Router Advertisements	IPv6 RA	ipv6_ra														
DHCPv6 Prefix Delegation	DHCPv6 prefix delegation	ipv6_pd														
Web: Start UCI: dhcp@dhcp[x].start Opt: start	Defines the offset from the network address for the start of the DHCP pool. Example: for network address 192.168.100.10/24, start=100, DHCP allocation pool will start at 192.168.100.100. For subnets greater than /24, it may be greater than 255 to span subnets. Alternatively, specify in IP address notation using the wildcard '0' where the octet is required to inherit bits from the interface IP address. Example: to define a DHCP scope starting from 10.1.20.0 on an interface with 10.1.0.0/16 address, set start to 0.0.20.1100 <table border="1"> <tr> <td>100</td> <td></td> </tr> <tr> <td>Range</td> <td></td> </tr> </table>	100		Range												
100																
Range																
Web: Limit UCI: dhcp@dhcp[x].limit Opt: limit	Defines the size of the address pool. Example: for network address 192.168.100.10/24, start=100, limit=150, DHCP allocation pool will be .100 to .249 <table border="1"> <tr> <td>150</td> <td></td> </tr> <tr> <td>Range</td> <td>0 - 255</td> </tr> </table>	150		Range	0 - 255											
150																
Range	0 - 255															
Web: Leasetime UCI: dhcp@dhcp[x].leasetime Opt: leasetime	Defines the lease time of addresses handed out to clients, for example 12h or 30m. <table border="1"> <tr> <td>12h</td> <td>12 hours</td> </tr> <tr> <td>Range</td> <td></td> </tr> </table>	12h	12 hours	Range												
12h	12 hours															
Range																
Web: n/a UCI: dhcp@dhcp[x].interface Opt: interface	Defines the interface that is served by this DHCP pool. This must be one of the configured interfaces. When configured through the web UI this will be automatically populated with the interface name															

11.3.2. DHCP Server: Advanced Settings

The DHCP server advanced settings section

Web Field/UCI/Package Option	Description				
Web: Dynamic DHCP UCI: dhcp@dhcp[x].dynamicdhcp Opt: dynamicdhcp	Defines whether to dynamically allocate DHCP leases. <table border="1"> <tr> <td>1</td> <td>Dynamically allocate leases.</td> </tr> <tr> <td>0</td> <td>Use /etc/ethers file for serving DHCP leases.</td> </tr> </table>	1	Dynamically allocate leases.	0	Use /etc/ethers file for serving DHCP leases.
1	Dynamically allocate leases.				
0	Use /etc/ethers file for serving DHCP leases.				
Web: Force UCI: dhcp@dhcp[x].force Opt: force	Forces DHCP serving on the specified interface even if another DHCP server is detected on the same network segment. <table border="1"> <tr> <td>0</td> <td>Disabled.</td> </tr> <tr> <td>1</td> <td>Enabled.</td> </tr> </table>	0	Disabled.	1	Enabled.
0	Disabled.				
1	Enabled.				
Web: IPv4-Netmask UCI: dhcp@dhcp[x].netmask Opt: netmask	Defines a netmask sent to clients that overrides the netmask as calculated from the interface subnet.				
Web: DHCP-Options UCI: dhcp@dhcp[x].dhcp_option Opt: list dhcp_option	Defines additional options to be added for this dhcp pool. For example with 'list dhcp_option 26,1470' or 'list dhcp_option mtu, 1470' you can assign a specific MTU per DHCP pool. Your client must accept the MTU option for this to work. Options that contain multiple values should be separated by a comma. Example: list dhcp_option 6,192.168.2.1,192.168.2.2 <table border="1"> <tr> <td></td> <td>No options defined.</td> </tr> <tr> <td>Syntax</td> <td>option_number, option_value</td> </tr> </table>		No options defined.	Syntax	option_number, option_value
	No options defined.				
Syntax	option_number, option_value				
Web: n/a UCI: dhcp@dhcp[x].networkid Opt: networkid	Assigns a network-id to all clients that obtain an IP address from this pool. <table border="1"> <tr> <td></td> <td>Use network from interface subnet.</td> </tr> <tr> <td>Range</td> <td></td> </tr> </table>		Use network from interface subnet.	Range	
	Use network from interface subnet.				
Range					

For more advanced configuration on the DHCP server, read 'DHCP server and DNS configuration section.

11.4. Interface Configuration Using Command Line

The configuration files are stored at `/etc/config/network`, `/etc/config/firewall` and `/etc/config/dhcp`.

Interface Configuration using UCI

```

root@VA_router:~# uci show network

#.. network.newinterface=interface
network.newinterface.proto=static
network.newinterface.ifname=eth0
network.newinterface.monitored=0
network.newinterface.ipaddr=2.2.2.2
network.newinterface.netmask=255.255.255.0
network.newinterface.gateway=2.2.2.10
network.newinterface.broadcast=2.2.2.255
network.newinterface.vlan_qos_map_ingress=1:2 2:1
network.ethalias1=alias
network.ethalias1.proto=static
network.ethalias1.interface=newinterface
network.ethalias1.ipaddr=10.10.10.1
network.ethalias1.netmask=255.255.255.0
network.ethalias1.gateway=10.10.10.10
network.ethalias1.bcast=10.10.10.255
network.ethalias1.dns=8.8.8.8

root@VA_router:~# uci show firewall

#.. firewall.@zone[0]=zone
firewall.@zone[0].name=lan
firewall.@zone[0].input=ACCEPT
firewall.@zone[0].output=ACCEPT
firewall.@zone[0].forward=ACCEPT
firewall.@zone[0].network=lan newinterface

root@VA_router:~# uci show dhcp

dhcp.@dhcp[0]=dhcp
dhcp.@dhcp[0].interface=newinterface
dhcp.@dhcp[0].mode=ipv4
dhcp.@dhcp[0].start=100
dhcp.@dhcp[0].limit=150
dhcp.@dhcp[0].leasetime=12h

```

To change any of the above values use **uci set** command.

11.4.1. Interface Configuration Using Package Options

```
root@VA_router:~# uci export network package network

config interface 'newinterface'
option proto 'static'
option ifname 'eth0'
option monitored '0'
option ipaddr '2.2.2.2'
option netmask '255.255.255.0'
option gateway '2.2.2.10'
option broadcast '2.2.2.255'
list vlan_qos_map_ingress '1:2'
list vlan_qos_map_ingress '2:1'
config alias 'ethalias1'
option proto 'static'
option interface 'newinterface'
option ipaddr '10.10.10.1'
option netmask '255.255.255.0'
option gateway '10.10.10.10'
option bcast '10.10.10.255'
option dns '8.8.8.8'

root@VA_router:~# uci export firewall package firewall

config zone
option name 'lan'
option input 'ACCEPT'
option output 'ACCEPT'
option output 'ACCEPT'
option forward 'ACCEPT'
option network 'lan newinterface'

root@VA_router:~# uci export dhcp package dhcp

config dhcp
option interface 'newinterface'
option mode 'ipv4'
option start '100'
option leasetime '12h'
option limit '150'
```

To change any of the above values use **uci set** command.

11.4.2. Loopback Interfaces UCI

Loopback interfaces are defined in exactly the same way as Ethernet interfaces.



NOTE

There is no software limitation as to how many loopback interfaces can exist on the router.

An example showing a partial uci export of a loopback interface configuration is shown below.

```
root@VA_router:~# uci export network
###
config interface 'loopback' option proto 'static' option ifname 'lo'
option ipaddr '127.0.0.1'
option netmask '255.0.0.0'
```



NOTE

We highly recommend you **do not** un-assign the 127.0.0.1 IP address from the loopback interface as this action will cause issues with the syslog mechanism and all internal logs will be routed outside the router.

If you must assign an alternative IP address to a loopback interface then you should create the alias of the loopback interface as shown below.

```
Config alias 'loopback_alt'
option interface 'loopback' option proto 'static'
```

```
option ipaddr '10.1.1.10'
option netmask '255.255.255.0'
```

11.5. Configuring Port Maps Using The Web Interface

Port Map Packages

Package	Sections
Network	va_switch

The new logical Ethernet interface needs to be mapped to a physical switch port. To configure the Ethernet switch physical port to logical interface mappings, go to the Port Map section at **Network -> Interfaces**.

Port Map
Map device ports to ethernet interfaces. Ports are marked with capital letters starting with 'A'. Type in space separated port numbers to fields below

eth0

eth1

eth2

eth3

The interface port map section

Web Field/UCI/Package Option	Description								
Web: eth0 UCI: network.@va_switch[0].eth0 Opt: eth0	Defines eth0 physical switch port mapping. Must be entered in upper case. <table border="1"> <tr><td>A</td><td>Eth0 assigned to switch port A</td></tr> <tr><td>B</td><td>Eth0 assigned to switch port B</td></tr> <tr><td>C</td><td>Eth0 assigned to switch port C</td></tr> <tr><td>D</td><td>Eth0 assigned to switch port D</td></tr> </table>	A	Eth0 assigned to switch port A	B	Eth0 assigned to switch port B	C	Eth0 assigned to switch port C	D	Eth0 assigned to switch port D
A	Eth0 assigned to switch port A								
B	Eth0 assigned to switch port B								
C	Eth0 assigned to switch port C								
D	Eth0 assigned to switch port D								
Web: eth1 UCI: network.@va_switch[0].eth1 Opt: eth1	Defines eth1 physical switch port mapping. Must be entered in upper case. <table border="1"> <tr><td>A</td><td>Eth1 assigned to switch port A</td></tr> <tr><td>B</td><td>Eth1 assigned to switch port B</td></tr> <tr><td>C</td><td>Eth1 assigned to switch port C</td></tr> <tr><td>D</td><td>Eth1 assigned to switch port D</td></tr> </table>	A	Eth1 assigned to switch port A	B	Eth1 assigned to switch port B	C	Eth1 assigned to switch port C	D	Eth1 assigned to switch port D
A	Eth1 assigned to switch port A								
B	Eth1 assigned to switch port B								
C	Eth1 assigned to switch port C								
D	Eth1 assigned to switch port D								
Web: eth2 UCI: network.@va_switch[0].eth2 Opt: eth2	Defines eth0 physical switch port mapping. Must be entered in upper case. <table border="1"> <tr><td>A</td><td>Eth2 assigned to switch port A</td></tr> <tr><td>B</td><td>Eth2 assigned to switch port B</td></tr> <tr><td>C</td><td>Eth2 assigned to switch port C</td></tr> <tr><td>D</td><td>Eth2 assigned to switch port D</td></tr> </table>	A	Eth2 assigned to switch port A	B	Eth2 assigned to switch port B	C	Eth2 assigned to switch port C	D	Eth2 assigned to switch port D
A	Eth2 assigned to switch port A								
B	Eth2 assigned to switch port B								
C	Eth2 assigned to switch port C								
D	Eth2 assigned to switch port D								
Web: eth3 UCI: network.@va_switch[0].eth3 Opt: eth3	Defines eth0 physical switch port mapping. Must be entered in upper case. <table border="1"> <tr><td>A</td><td>Eth3 assigned to switch port A</td></tr> <tr><td>B</td><td>Eth3 assigned to switch port B</td></tr> <tr><td>C</td><td>Eth3 assigned to switch port C</td></tr> <tr><td>D</td><td>Eth3 assigned to switch port D</td></tr> </table>	A	Eth3 assigned to switch port A	B	Eth3 assigned to switch port B	C	Eth3 assigned to switch port C	D	Eth3 assigned to switch port D
A	Eth3 assigned to switch port A								
B	Eth3 assigned to switch port B								
C	Eth3 assigned to switch port C								
D	Eth3 assigned to switch port D								

11.6. Configuring Port Maps Using UCI

The configuration files are stored on `/etc/config/network`

```

root@VA_router:~# uci show network
network.@va_switch[0]=va_switch
network.@va_switch[0].eth0=A
network.@va_switch[0].eth1=B
network.@va_switch[0].eth2=C
network.@va_switch[0].eth3=D

```

To change any of the above values use `uci set` command.

11.7. Configuring Port Map Using Package Options

The configuration files are stored on `/etc/config/network`

```
root@VA_router:~# uci export network

config va_switch
option eth0 'A'
option eth1 'B'
option eth2 'C'
option eth3 'D'
```

To change any of the above values use `uci set` command.

ATM Bridges

The ATM bridges section is not used when configuring an Ethernet interface.

11.8. Interface Diagnostics



NOTE

The information presented on screen and data output using UCI depends on the actual mobile hardware being used. Therefore, the interfaces or output you see may differ from the samples shown here.

Interface Status

```
root@VA_router:~# ifconfig

3g-CDMA Link encap:Point-to-Point Protocol

inet addr:10.33.152.100 P-t-P:178.72.0.237 Mask:255.255.255.255

UP POINTOPOINT RUNNING NOARP MULTICAST MTU:1400 Metric:1

RX packets:6 errors:0 dropped:0 overruns:0 frame:0

TX packets:23 errors:0 dropped:0 overruns:0 carrier:0 collisions:0 txqueuelen:3

RX bytes:428 (428.0 B) TX bytes:2986 (2.9 KiB)

eth0 Link encap:Ethernet HWaddr 00:E0:C8:12:12:15

inet addr:192.168.100.1 Bcast:192.168.100.255

Mask:255.255.255.0

inet6 addr: fe80::2e0:c8ff:fe12:1215/64 Scope:Link

UP BROADCAST RUNNING MULTICAST MTU:1500 Metric:1

RX packets:6645 errors:0 dropped:0 overruns:0 frame:0

TX packets:523 errors:0 dropped:0 overruns:0 carrier:0 collisions:0 txqueuelen:1000

RX bytes:569453 (556.1 KiB) TX bytes:77306 (75.4 KiB)

lo Link encap:Local Loopback

inet addr:127.0.0.1 Mask:255.0.0.0

inet6 addr: ::1/128 Scope:Host

UP LOOPBACK RUNNING MTU:16436 Metric:1

RX packets:385585 errors:0 dropped:0 overruns:0 frame:0

TX packets:385585 errors:0 dropped:0 overruns:0 carrier:0

collisions:0 txqueuelen:0

RX bytes:43205140 (41.2 MiB) TX bytes:43205140 (41.2 MiB)
```

To display a specific interface, enter:

```
root@VA_router:~# ifconfig eth0

eth0 Link encap:Ethernet HWaddr 00:E0:C8:12:12:15

inet addr:192.168.100.1 Bcast:192.168.100.255

Mask:255.255.255.0

inet6 addr: fe80::2e0:c8ff:fe12:1215/64 Scope:Link

UP BROADCAST RUNNING MULTICAST MTU:1500 Metric:1

RX packets:7710 errors:0 dropped:0 overruns:0 frame:0

TX packets:535 errors:0 dropped:0 overruns:0 carrier:0

collisions:0 txqueuelen:1000

RX bytes:647933 (632.7 KiB) TX bytes:80978 (79.0 KiB)
```

11.9. Route Status

To show the current routing status, enter:

```
root@VA_router:~# route -n Kernel IP routing table
```

Destination	Gateway	Genmask	Flags	Metric	Ref	Use	Iface
192.168.100.0	*	255.255.255.0	U	0	0	0	eth



NOTE

A route will only be displayed in the routing table when the interface is up.

11.10. ARP Table Status

To show the current ARP table of the router, enter:

```
root@va_router:~# arp
```

? (10.67.253.141)	at 30:30:41:30:43:36 [ether]	on eth8
? (10.47.48.1)	at 0a:44:b2:06 [ether]	on gre-gre1

12. Configuring VLAN

Maximum number of VLANS supported

Merlin routers support up to 4095 VLANs.

Package	Sections
Network	

12.1. Configuring VLAN Using The Web Interface

To create and configure a VLAN interface using the web interface, in the top menu, select **Network -> Interfaces**.

Click **Add new interface**. The Create Interface page appears.

Create Interface

Name of the new interface The allowed characters are: A-Z, a-z, 0-9 and _

Protocol of the new interface

Create a bridge over multiple interfaces

Cover the following interface

- Ethernet Adapter: "eth0" (lan)
- Ethernet Adapter: "eth1" (lan1)
- Ethernet Adapter: "eth2"
- Ethernet Adapter: "eth3"
- Ethernet Adapter: "eth4"
- Ethernet Adapter: "lo" (loopback)
- Ethernet Adapter: "teql0"
- Ethernet Adapter: "tunl0"
- Custom Interface:

Note: If you choose an interface here which is part of another network, it will be moved into this network.

The Create interface page

Web Field/UCI/Package Option	Description																										
Web: Name of the new interface UCI: network.vlan1=interface Opt: interface	Type the name of the new interface. For example, VLAN1																										
Web: Protocol of the new interface UCI: network.vlan_tets.proto Opt: proto	Protocol type. Select Static . <table border="1" data-bbox="632 432 1370 891"> <thead> <tr> <th>Option</th> <th>Description</th> </tr> </thead> <tbody> <tr> <td>Static</td> <td>Static configuration with fixed address and netmask.</td> </tr> <tr> <td>DHCP Client</td> <td>Address and netmask are assigned by DHCP</td> </tr> <tr> <td>Unmanaged</td> <td>Unspecified</td> </tr> <tr> <td>IPv6-inIPv4 (RFC4213)</td> <td>Used with tunnel brokers</td> </tr> <tr> <td>IPv6-over-IPv4</td> <td>Stateless IPv6 over IPv4 transport</td> </tr> <tr> <td>GRE</td> <td>Generic Routing Encapsulation protocol</td> </tr> <tr> <td>IOT</td> <td></td> </tr> <tr> <td>L2TP</td> <td>Layer 2 Tunnelling Protocol</td> </tr> <tr> <td>PPP</td> <td>Point to Point Protocol</td> </tr> <tr> <td>PPPoE</td> <td>PPP over Ethernet</td> </tr> <tr> <td>PPPoATM</td> <td>PPP over ATM</td> </tr> <tr> <td>LTE/UMTS/GPRS/EV-DO</td> <td>CDMA, UMTS, or GPRS connection using an AT-style 3g modem</td> </tr> </tbody> </table>	Option	Description	Static	Static configuration with fixed address and netmask.	DHCP Client	Address and netmask are assigned by DHCP	Unmanaged	Unspecified	IPv6-inIPv4 (RFC4213)	Used with tunnel brokers	IPv6-over-IPv4	Stateless IPv6 over IPv4 transport	GRE	Generic Routing Encapsulation protocol	IOT		L2TP	Layer 2 Tunnelling Protocol	PPP	Point to Point Protocol	PPPoE	PPP over Ethernet	PPPoATM	PPP over ATM	LTE/UMTS/GPRS/EV-DO	CDMA, UMTS, or GPRS connection using an AT-style 3g modem
Option	Description																										
Static	Static configuration with fixed address and netmask.																										
DHCP Client	Address and netmask are assigned by DHCP																										
Unmanaged	Unspecified																										
IPv6-inIPv4 (RFC4213)	Used with tunnel brokers																										
IPv6-over-IPv4	Stateless IPv6 over IPv4 transport																										
GRE	Generic Routing Encapsulation protocol																										
IOT																											
L2TP	Layer 2 Tunnelling Protocol																										
PPP	Point to Point Protocol																										
PPPoE	PPP over Ethernet																										
PPPoATM	PPP over ATM																										
LTE/UMTS/GPRS/EV-DO	CDMA, UMTS, or GPRS connection using an AT-style 3g modem																										
Web: Create a bridge over multiple interfaces UCI: network.vlan1.type Opt: ifname	Create a bridge over multiple interfaces.																										
Web: Cover the following interface UCI: network.vlan1.ifname Opt: ifname	Check the Custom Interface radio button. Enter a name, for example, eth0.100. this will assign VLAN 100 to the eth0 interface.																										

Click **Submit**. The Interfaces page for VLAN1 appears.

12.2. General Setup: VLAN

WAN VLAN1 **VLAN2** LAN

Interfaces - VLAN1

On this page you can configure the network interfaces. You can bridge several interfaces by ticking the "bridge interfaces" field and enter the names of several network interfaces separated by spaces. You can also use VLAN notation `INTERFACE.VLANNR` (e.g.: `eth0.1`).

Common Configuration

General Setup **Advanced Settings** Physical Settings Firewall Settings

Status	 eth0.1	Uptime: 0h 4m 41s MAC Address: 00:E0:C8:10:10:50 RX: 0.00 B (0 Pkts.) TX: 252.00 B (6 Pkts.) IPv4: 172.16.100.1/24
--------	--	---

Protocol:

IPv4 address:

IPv4 netmask:

IPv4 gateway:

IPv4 broadcast:

Use custom DNS servers:

The common configuration general setup page

Web Field/UCI/Package Option	Description																										
Web: Protocol UCI: network.VLAN1.proto Opt: proto	Protocol type. <table border="1"> <thead> <tr> <th>Option</th> <th>Description</th> </tr> </thead> <tbody> <tr> <td>Static</td> <td>Static configuration with fixed address and netmask.</td> </tr> <tr> <td>DHCP Client</td> <td>Address and netmask are assigned by DHCP</td> </tr> <tr> <td>Unmanaged</td> <td>Unspecified</td> </tr> <tr> <td>IPv6-inIPv4 (RFC4213)</td> <td>Used with tunnel brokers</td> </tr> <tr> <td>IPv6-over-IPv4</td> <td>Stateless IPv6 over IPv4 transport</td> </tr> <tr> <td>GRE</td> <td>Generic Routing Encapsulation protocol</td> </tr> <tr> <td>IOT</td> <td></td> </tr> <tr> <td>L2TP</td> <td>Layer 2 Tunnelling Protocol</td> </tr> <tr> <td>PPP</td> <td>Point to Point Protocol</td> </tr> <tr> <td>PPPoE</td> <td>PPP over Ethernet</td> </tr> <tr> <td>PPPoATM</td> <td>PPP over ATM</td> </tr> <tr> <td>LTE/UMTS/GPRS/EV-DO</td> <td>CDMA, UMTS, or GPRS connection using an AT-style 3g modem</td> </tr> </tbody> </table>	Option	Description	Static	Static configuration with fixed address and netmask.	DHCP Client	Address and netmask are assigned by DHCP	Unmanaged	Unspecified	IPv6-inIPv4 (RFC4213)	Used with tunnel brokers	IPv6-over-IPv4	Stateless IPv6 over IPv4 transport	GRE	Generic Routing Encapsulation protocol	IOT		L2TP	Layer 2 Tunnelling Protocol	PPP	Point to Point Protocol	PPPoE	PPP over Ethernet	PPPoATM	PPP over ATM	LTE/UMTS/GPRS/EV-DO	CDMA, UMTS, or GPRS connection using an AT-style 3g modem
Option	Description																										
Static	Static configuration with fixed address and netmask.																										
DHCP Client	Address and netmask are assigned by DHCP																										
Unmanaged	Unspecified																										
IPv6-inIPv4 (RFC4213)	Used with tunnel brokers																										
IPv6-over-IPv4	Stateless IPv6 over IPv4 transport																										
GRE	Generic Routing Encapsulation protocol																										
IOT																											
L2TP	Layer 2 Tunnelling Protocol																										
PPP	Point to Point Protocol																										
PPPoE	PPP over Ethernet																										
PPPoATM	PPP over ATM																										
LTE/UMTS/GPRS/EV-DO	CDMA, UMTS, or GPRS connection using an AT-style 3g modem																										
Web: IPv4 address UCI: network.VLAN1.ipaddr Opt: ipaddr	The IPv4 address of the interface. This is optional if an IPv6 address is provided.																										
Web: IPv4 netmask UCI: network.VLAN1.netmask Opt: netmask	Subnet mask to be applied to the IP address of this interface.																										
Web: IPv4 gateway UCI: network.VLAN1.gateway Opt: gateway	IPv4 default gateway to assign to this interface (optional).																										
Web: Use custom DNS servers UCI: network.VLAN1.dns Opt: dns	List of DNS server IP addresses (optional).																										

12.3. Firewall Settings: VLAN

Use this section to select the firewall zone you want to assign to the VLAN interface.

Select **unspecified** to remove the interface from the associated zone or fill out the create field to define a new zone and attach the interface to it.

The common configuration firewall settings page

When you have added all the VLAN interfaces you require, click **Save & Apply**.

12.4. Viewing VLAN Interface Settings

To view the new VLAN interface settings, in the top menu, select **Network -> Interfaces**. The Interfaces Overview page appears.

The example below shows two VLAN interfaces configured.

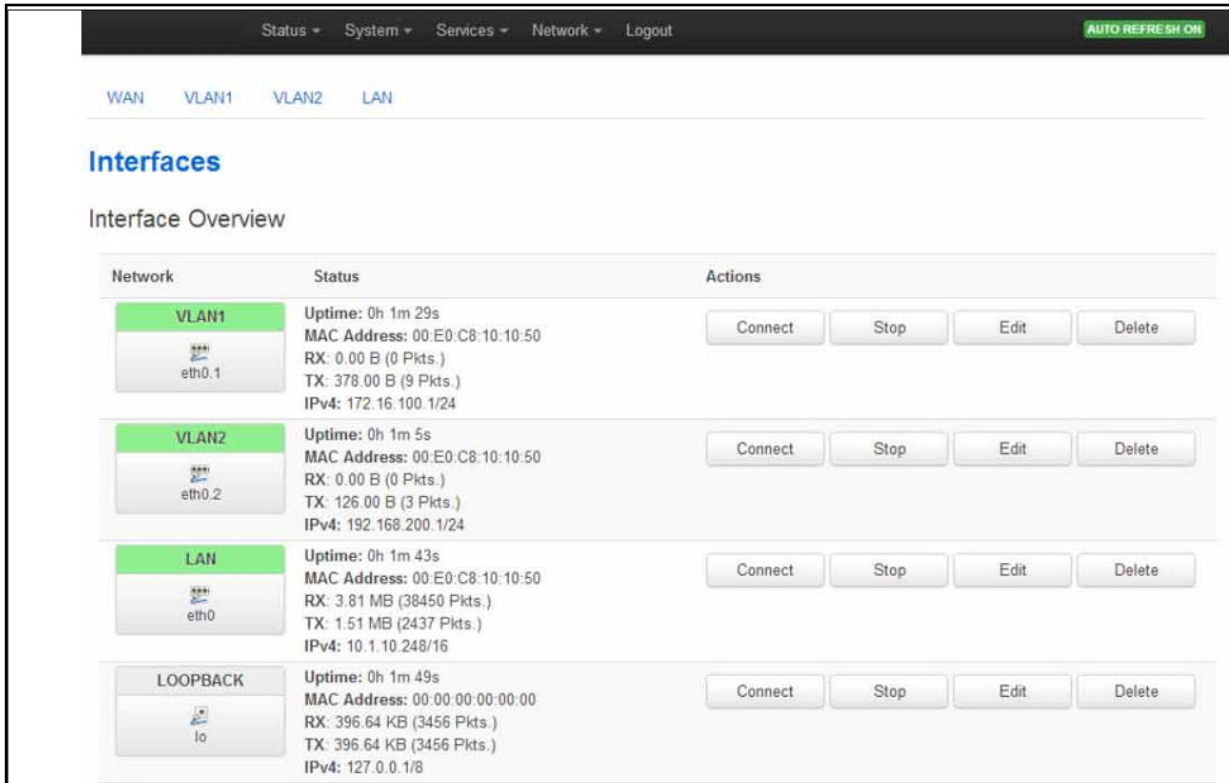

The screenshot shows the Merlin 4400 Management GUI. At the top, there is a navigation menu with 'Status', 'System', 'Services', 'Network', and 'Logout'. A green 'AUTO REFRESH ON' button is in the top right. Below the menu, there are tabs for 'WAN', 'VLAN1', 'VLAN2', and 'LAN'. The main heading is 'Interfaces' and the sub-heading is 'Interface Overview'. Below this is a table with columns for 'Network', 'Status', and 'Actions'. The table lists four interfaces: VLAN1 (eth0.1), VLAN2 (eth0.2), LAN (eth0), and LOOPBACK (lo). Each interface entry shows its uptime, MAC address, and traffic statistics (RX and TX). The 'Actions' column for each interface contains buttons for 'Connect', 'Stop', 'Edit', and 'Delete'.

Network	Status	Actions
VLAN1 eth0.1	Uptime: 0h 1m 29s MAC Address: 00:E0:C8:10:10:50 RX: 0.00 B (0 Pkts.) TX: 378.00 B (9 Pkts.) IPv4: 172.16.100.1/24	Connect Stop Edit Delete
VLAN2 eth0.2	Uptime: 0h 1m 5s MAC Address: 00:E0:C8:10:10:50 RX: 0.00 B (0 Pkts.) TX: 126.00 B (3 Pkts.) IPv4: 192.168.200.1/24	Connect Stop Edit Delete
LAN eth0	Uptime: 0h 1m 43s MAC Address: 00:E0:C8:10:10:50 RX: 3.81 MB (38450 Pkts.) TX: 1.51 MB (2437 Pkts.) IPv4: 10.1.10.248/16	Connect Stop Edit Delete
LOOPBACK lo	Uptime: 0h 1m 49s MAC Address: 00:00:00:00:00:00 RX: 396.64 KB (3456 Pkts.) TX: 396.64 KB (3456 Pkts.) IPv4: 127.0.0.1/8	Connect Stop Edit Delete

The interface overview page showing two VLAN interfaces

12.5. Configuring VLAN Using UCI

You can configure VLANs through CLI. The VLAN configuration file is stored on: `/etc/config/network`

```
# uci export network
package network
config interface 'vlan100'
option proto 'static'
option ifname 'eth0.100'
option monitored '0'
option ipaddr '192.168.100.1'
option netmask '255.255.255.0'
option gateway '192.168.100.10'
option broadcast '192.168.100.255'
option dns '8.8.8.8'
```

Modify these settings by running `uci set <parameter>` command.

When specifying the ifname ensure that it is written in dotted mode, that is, eth1.100 where eth1 is the physical interface assigned to VLAN tag 100.



NOTE

VLAN1 is, by default, the native VLAN and will not be tagged.

13. Configuring Mobile Manager

The Mobile Manager feature allows you to configure SIM settings.

Configuration Package Used

Package	Sections
mobile	main
	callers
	roaming_template

13.1. Configuring Mobile Manager Using The Web Interface

Select **Services -> Mobile Manager**. The Mobile Manager page appears. There are four sections in the mobile manager page:

Section	Description
Basic	Enable SMS, configure SIM pin code and select roaming SIM.
Advanced	Configure advanced options such as collect ICCIDs and temperature polling interval.
LTE	LTE-specific settings
CDMA*	CDMA configuration.
Callers	Configure callers that can use SMS.
Roaming Interface Template	Configure Preferred Roaming List options.
*Option available only for CDMA modules.	

13.1.1. Mobile Manager: Basic Settings

MAIN

Basic **Advanced** LTE CDMA

SMS Enable

PIN-code for SIM1

PIN-code for SIM2

The mobile manager basic settings page

Web Field/UCI/Package Option	Description				
Web: SMS Enable UCI: mobile.main.sms Opt: sms	Enables or disables SMS functionality. <table border="1"> <tr> <td>Default: 1</td> <td>Enabled</td> </tr> <tr> <td>0</td> <td>Disabled</td> </tr> </table>	Default: 1	Enabled	0	Disabled
Default: 1	Enabled				
0	Disabled				
Web: PIN code for SIM1 UCI: mobile.main.sim1pin Opt: sim1pin	Depending on the SIM card specify the pin code for SIM 1. <table border="1"> <tr> <td>Default</td> <td>Blank</td> </tr> <tr> <td>Range</td> <td>Depends on the SIM provider</td> </tr> </table>	Default	Blank	Range	Depends on the SIM provider
Default	Blank				
Range	Depends on the SIM provider				
Web: PIN code for SIM2 UCI: mobile.main.sim2pin Opt: sim2pin	Depending on the SIM card specify the pin code for SIM 2. <table border="1"> <tr> <td>Default</td> <td>Blank</td> </tr> <tr> <td>Range</td> <td>Depends on the SIM provider</td> </tr> </table>	Default	Blank	Range	Depends on the SIM provider
Default	Blank				
Range	Depends on the SIM provider				

13.1.2. Mobile Manager: Advanced Settings

MAIN

Basic **Advanced** LTE CDMA

Collect ICCIDs [Collect ICCIDs on startup](#)

Force Mode [Select network interface mode](#)

Temperature Polling Interval (Seconds)

Automatic Firmware Selection [Select firmware based on network operator - only supported on some radio modules](#)

Allow USB Power Cycle [Power cycle usb bus if modem disappeared from the USB bus for more then 40 seconds](#)

The mobile manager advanced settings page

Web Field/UCI/Package Option	Description									
Web: Collect ICCIDs UCI: mobile.main.init_get_iccids Opt: init_get_iccids	Enables or disables integrated circuit card identifier ICCIDs collection functionality. If enabled, then both SIM 1 and SIM 2 ICCIDs will be collected; otherwise it will default to SIM 1. This will be displayed under mobile stats. <table border="1"> <tr> <td>Default: 1</td> <td>Enabled</td> </tr> <tr> <td>0</td> <td>Disabled</td> </tr> </table>	Default: 1	Enabled	0	Disabled					
Default: 1	Enabled									
0	Disabled									
Web: Force Mode UCI: mobile.main.force_mode Opt: force_mode	Defines whether to operate mobile modem in PPP or Ethernet mode. The mode will be dependent on the service provided by the mobile provider. In general, this is Ethernet mode (default). <p>Note: It should not be necessary to force PPP mode – contact your support representative for advice.</p> <table border="1"> <thead> <tr> <th>Web</th> <th>UCI</th> <th>Description</th> </tr> </thead> <tbody> <tr> <td>Automatic</td> <td></td> <td>Ethernet mode (option not present)</td> </tr> <tr> <td>PPP</td> <td>tty</td> <td>Enable PPP mode</td> </tr> </tbody> </table>	Web	UCI	Description	Automatic		Ethernet mode (option not present)	PPP	tty	Enable PPP mode
Web	UCI	Description								
Automatic		Ethernet mode (option not present)								
PPP	tty	Enable PPP mode								
Web: Temperature Polling Interval UCI: mobile.main.temp_poll_interval_sec Opt: temp_poll_interval_sec	Defines the time in seconds to poll the mobile module for temperature. Set to 0 to disable.									
Web: Automatic Firmware Selection UCI: mobile.main.enable_firmware_autoselect Opt: enable_firmware_autoselect	Enables the selection of an operator-specific firmware in the radio module. The selection is based on the ICCID of the used SIM. At module initialisation the IMSI is checked and if necessary, the correct firmware image in the module will be activated. <p>Note: activation of the firmware will lead to a delayed startup of the network interface associated with the radio module.</p> <p>Note: this feature is currently only supported for the Telit LE910NA V2 module. Here Verizon-specific firmware will be selected if the ICCID starts with "891480".</p> <table border="1"> <tr> <td>Default: 0</td> <td>Disabled</td> </tr> <tr> <td>1</td> <td>Enabled</td> </tr> </table>	Default: 0	Disabled	1	Enabled					
Default: 0	Disabled									
1	Enabled									
Web: Allow USB Power Cycle UCI: mobile.main.allow_usb_powercycle Opt: allow_usb_powercycle	Defines whether to automatically power cycle the USB modem if a mobile module is not detected for 40 seconds. <table border="1"> <tr> <td>Default: 1</td> <td>Enabled</td> </tr> <tr> <td>0</td> <td>Disabled</td> </tr> </table>	Default: 1	Enabled	0	Disabled					
Default: 1	Enabled									
0	Disabled									

13.1.3. Mobile Manager: LTE Settings

MAIN

Basic Advanced **LTE** CDMA

SIM1: LTE Bands ⓘ *Comma-seprated list of LTE bands to use with SIM1*

SIM2: LTE Bands ⓘ *Comma-seprated list of LTE bands to use with SIM2*

SIM 1: Default bearer APN enabled

SIM1: Default bearer APN

SIM1: Default bearer APN username

SIM1: Default bearer APN password ⓘ

SIM1: Default bearer APN authentication type **CHAP** ⓘ *Selects APN authentication type*

SIM 1: Default bearer IPv4 enabled

SIM 1: Default bearer IPv6 enabled

SIM 2: Default bearer APN enabled

The mobile manager LTE settings page

Web Field/UCI/Package Option	Description									
Web: SIM1: LTE bands UCI: mobile.main.sim1_lte_bands Opt: sim1_lte_bands	Depending on the SIM card, specify the LTE bands for SIM 1. Comma delimiter. Example: <pre>option sim1_lte_bands '3,20'</pre> Limits LTE bands to 3 and 20 Note: currently only supported by Hucom/Wetelcom, SIMCom7100, Cellient MPL200, Asiatel and Quectel radio modules. <table border="1"> <tr> <td>Default:</td> <td>Blank</td> </tr> <tr> <td>Range</td> <td>LTE bands range from 1 to 70.</td> </tr> </table>	Default:	Blank	Range	LTE bands range from 1 to 70.					
Default:	Blank									
Range	LTE bands range from 1 to 70.									
Web: SIM2: LTE bands UCI: mobile.main.sim2_lte_bands Opt:sim2_lte_bands	Depending on the SIM card, specify the LTE bands for SIM 2. Comma delimiter. Example: <pre>option sim2_lte_bands '3,20'</pre> Limits LTE bands to 3 and 20 Note: currently only supported by Hucom/Wetelcom, SIMCom7100, Cellient MPL200, Asiatel and Quectel radio modules. <table border="1"> <tr> <td>Default:</td> <td>Blank</td> </tr> <tr> <td>Range</td> <td>LTE bands range from 1 to 70.</td> </tr> </table>	Default:	Blank	Range	LTE bands range from 1 to 70.					
Default:	Blank									
Range	LTE bands range from 1 to 70.									
Web: SIM1: Default bearer APN enabled UCI: mobile.main.sim1_lte_default_apn_enabled Opt: sim1_lte_default_apn_enabled	Enables the use of a specific LTE attach bearer. <table border="1"> <tr> <td>Default: 0</td> <td>Disabled</td> </tr> <tr> <td>1</td> <td>Enabled</td> </tr> </table>	Default: 0	Disabled	1	Enabled					
Default: 0	Disabled									
1	Enabled									
Web: SIM1: Default bearer APN UCI: mobile.main.sim1_lte_default_apn Opt: sim1_lte_default_apn	Specifies the LTE attach bearer APN.									
Web: SIM1: Default bearer APN username UCI: mobile.main.sim1_lte_default_apn_username Opt: sim1_lte_default_apn_username	Username for authentication with attach bearer APN.									
Web: SIM1: Default bearer APN password UCI: mobile.main.sim1_lte_default_apn_password Opt: sim1_lte_default_apn_password	Password for authentication with attach bearer APN. <table border="1"> <thead> <tr> <th>Web</th> <th>Description</th> <th>UCI</th> </tr> </thead> <tbody> <tr> <td>CHAP</td> <td>CHAP authentication</td> <td>2</td> </tr> <tr> <td>PAP</td> <td>PAP authentication</td> <td>1</td> </tr> </tbody> </table>	Web	Description	UCI	CHAP	CHAP authentication	2	PAP	PAP authentication	1
Web	Description	UCI								
CHAP	CHAP authentication	2								
PAP	PAP authentication	1								
Web: SIM1: Default bearer IPv4 enabled UCI: mobile.main.sim1_lte_default_apn_ipv4 Opt: sim1_lte_default_apn_ipv4	Enables IPv4 for the attach bearer <table border="1"> <tr> <td>Default: 0</td> <td>IPv4 disabled</td> </tr> <tr> <td>1</td> <td>IPv4 enabled</td> </tr> </table>	Default: 0	IPv4 disabled	1	IPv4 enabled					
Default: 0	IPv4 disabled									
1	IPv4 enabled									
Web: SIM1: Default bearer IPv6 enabled UCI: mobile.main.sim1_lte_default_apn_ipv6 Opt: sim1_lte_default_apn_ipv6	Enables IPv6 for the attach bearer. <table border="1"> <tr> <td>Default: 0</td> <td>Disabled</td> </tr> <tr> <td>1</td> <td>Enabled</td> </tr> </table>	Default: 0	Disabled	1	Enabled					
Default: 0	Disabled									
1	Enabled									
Web: SIM2: Default bearer APN UCI: mobile.main.sim2_lte_default_apn Opt: sim2_lte_default_apn	Specifies the LTE attach bearer APN.									
Web: SIM2: Default bearer APN username UCI: mobile.main.sim2_lte_default_apn_username	Username for authentication with attach bearer APN.									

Web Field/UCI/Package Option	Description									
Opt: sim2_lte_default_apn_username										
Web: SIM2: Default bearer APN password UCI: mobile.main.sim2_lte_default_apn_password Opt: sim2_lte_default_apn_password	Password for authentication with attach bearer APN.									
Web: SIM2: Default bearer APN authentication type UCI: mobile.main.sim2_lte_default_apn_password Opt: sim2_lte_default_apn_password	Selects the APN authentication mechanism. <table border="1"> <thead> <tr> <th>Web</th> <th>Description</th> <th>UCI</th> </tr> </thead> <tbody> <tr> <td>CHAP</td> <td>CHAP authentication</td> <td>2</td> </tr> <tr> <td>PAP</td> <td>PAP authentication</td> <td>1</td> </tr> </tbody> </table>	Web	Description	UCI	CHAP	CHAP authentication	2	PAP	PAP authentication	1
Web	Description	UCI								
CHAP	CHAP authentication	2								
PAP	PAP authentication	1								
Web: SIM2: Default bearer IPv4 enabled UCI: mobile.main.sim2_lte_default_apn_ipv4 Opt: sim2_lte_default_apn_ipv4	Enables IPv4 for the attach bearer <table border="1"> <tbody> <tr> <td>Default: 0</td> <td>IPv4 disabled</td> </tr> <tr> <td>1</td> <td>IPv4 enabled</td> </tr> </tbody> </table>	Default: 0	IPv4 disabled	1	IPv4 enabled					
Default: 0	IPv4 disabled									
1	IPv4 enabled									
Web: SIM2: Default bearer IPv6 enabled UCI: mobile.main.sim2_lte_default_apn_ipv6 Opt: sim2_lte_default_apn_ipv6	Enables IPv6 for the attach bearer <table border="1"> <tbody> <tr> <td>Default: 0</td> <td>IPv6 disabled</td> </tr> <tr> <td>Range</td> <td>IPv6 enabled</td> </tr> </tbody> </table>	Default: 0	IPv6 disabled	Range	IPv6 enabled					
Default: 0	IPv6 disabled									
Range	IPv6 enabled									

13.1.4. Mobile Manager: CDMA Settings

This configuration page is only supported for CDMA modules.

MAIN

Basic Advanced **LTE** CDMA

IMSI ⓘ *If specified over-writes IMSI stored in radio module*

HDR Auth User ID ⓘ *AN-PPP user id. Supported on Cellient module only*

HDR Auth Password ⓘ *AN-PPP password. Supported on Cellient module only*

Ordered Registration triggers module reboot

Station Class Mark

Slot Cycle Index

Slot Mode

Mobile Directory Number

MOB_TERM_HOME registration flag

MOB_TERM_FOR_SID registration flag

MOB_TERM_FOR_NID registration flag

The mobile manager CDMA page

Web Field/UCI/Package Option	Description				
Web: IMSI UCI: mobile.main.imsi Opt: imsi	Allows the IMSI (International Mobile Subscriber Identity) to be changed. <table border="1"> <tr> <td>Default:</td> <td>Programmed in module.</td> </tr> <tr> <td>Range</td> <td>Up to 15 digits</td> </tr> </table>	Default:	Programmed in module.	Range	Up to 15 digits
Default:	Programmed in module.				
Range	Up to 15 digits				
Web: HDR Auth User ID UCI: mobile.main.hdr_userid Opt: hdr_userid	AN-PPP user ID. Supported on Cellient CDMA modem only. <table border="1"> <tr> <td>Default:</td> <td>Blank</td> </tr> <tr> <td>Range</td> <td>Depends on the CDMA provider.</td> </tr> </table>	Default:	Blank	Range	Depends on the CDMA provider.
Default:	Blank				
Range	Depends on the CDMA provider.				
Web: HDR Auth User Password UCI: mobile.main.hdr_password Opt: hdr_password	AN-PPP password. Supported on Cellient CDMA modem only. <table border="1"> <tr> <td>Default:</td> <td>Blank</td> </tr> <tr> <td>Range</td> <td>Depends on the CDMA provider.</td> </tr> </table>	Default:	Blank	Range	Depends on the CDMA provider.
Default:	Blank				
Range	Depends on the CDMA provider.				
Web: Ordered Registration triggers module reboot UCI: mobile.main. mobile.main.cdma_ordered_registration_reboot_enabled Opt: cdma_ordered_registration_reboot_enabled	Enables or disables rebooting the module after the order registration command is received from a network. <table border="1"> <tr> <td>Default: 0</td> <td>Disabled</td> </tr> <tr> <td>1</td> <td>Enabled</td> </tr> </table>	Default: 0	Disabled	1	Enabled
Default: 0	Disabled				
1	Enabled				
Web: Station Class Mark UCI: mobile.main.cdma_station_class_mark Opt: cdma_station_class_mark	Allows the station class mark for the MS to be changed. <table border="1"> <tr> <td>Default:</td> <td>58</td> </tr> <tr> <td>Range</td> <td>0-255</td> </tr> </table>	Default:	58	Range	0-255
Default:	58				
Range	0-255				
Web: Slot Cycle Index UCI: mobile.main.cdma_slot_cycle_index Opt: cdma_slot_cycle_index	Defines the desired slot cycle index if different from the default. <table border="1"> <tr> <td>Default:</td> <td>2</td> </tr> <tr> <td>Range</td> <td>0-7</td> </tr> </table>	Default:	2	Range	0-7
Default:	2				
Range	0-7				
Web: Slot Mode UCI: mobile.main.cdma_slot_mode Opt: cdma_slot_mode	Specifies the slot mode. <table border="1"> <tr> <td>Default:</td> <td>0</td> </tr> <tr> <td>Range</td> <td></td> </tr> </table>	Default:	0	Range	
Default:	0				
Range					
Web: Mobile Directory Number UCI: mobile.main.cdma_mobile_directory_number Opt: cdma_mobile_directory_number	Allows the mobile directory number (MDN) to be changed. <table border="1"> <tr> <td>Default:</td> <td>Programmed in module.</td> </tr> <tr> <td>Range</td> <td>Up to 15 digits</td> </tr> </table>	Default:	Programmed in module.	Range	Up to 15 digits
Default:	Programmed in module.				
Range	Up to 15 digits				
Web: MOB_TERM_HOME registration flag UCI: mobile.main. cdma_mob_term_home_registration_flag Opt: cdma_mob_term_home_registration_flag	The MOB_TERM_HOME registration flag. <table border="1"> <tr> <td>Default: 1</td> <td>Enabled</td> </tr> <tr> <td>0</td> <td>Disabled</td> </tr> </table>	Default: 1	Enabled	0	Disabled
Default: 1	Enabled				
0	Disabled				
Web: MOB_TERM_FOR_SID registration flag UCI: mobile.main. cdma_mob_term_for_sid_registration_flag Opt: cdma_mob_term_for_sid_registration_flag	The MOB_TERM_FOR_SID registration flag. <table border="1"> <tr> <td>Default: 1</td> <td>Enabled</td> </tr> <tr> <td>0</td> <td>Disabled</td> </tr> </table>	Default: 1	Enabled	0	Disabled
Default: 1	Enabled				
0	Disabled				
Web: MOB_TERM_FOR_NID registration flag UCI: mobile.main. cdma_mob_term_for_nid_registration_flag Opt: cdma_mob_term_for_sid_registration_flag	The MOB_TERM_FOR_NID registration flag. <table border="1"> <tr> <td>Default: 1</td> <td>Enabled</td> </tr> <tr> <td>0</td> <td>Disabled</td> </tr> </table>	Default: 1	Enabled	0	Disabled
Default: 1	Enabled				
0	Disabled				
Web: Access Overload Control UCI: mobile.main.cdma_access_overload_control	Allows the access overload class to be changed. <table border="1"> <tr> <td>Default:</td> <td>Programmed into module as part of IMSI</td> </tr> </table>	Default:	Programmed into module as part of IMSI		
Default:	Programmed into module as part of IMSI				

Web Field/UCI/Package Option	Description				
Opt: cdma_access_overload_control	<table border="1"> <tr> <td>1</td> <td>Enabled</td> </tr> </table>	1	Enabled		
1	Enabled				
Web: Preferred Serving System UCI: mobile.main.cdma_preferred_serving_system Opt: cdma_preferred_serving_system	The CDMA Preferred Serving System(A/B). <table border="1"> <tr> <td>Default:</td> <td>5</td> </tr> </table>	Default:	5		
Default:	5				
Web: Digital Analog Mode Preference UCI: cdma_digital_analog_mode_preference Opt: cdma_digital_analog_mode_preference	Digital/analog mode preference. <table border="1"> <tr> <td>Default:</td> <td>4</td> </tr> </table>	Default:	4		
Default:	4				
Web: Primary Channel A UCI: mobile.main.cdma_primary_channel_a Opt: cdma_primary_channel_a.	Allows the primary channel (A) to be changed. <table border="1"> <tr> <td>Default:</td> <td>283</td> </tr> <tr> <td>Range</td> <td>1-2016. Any band class 5 channel number.</td> </tr> </table>	Default:	283	Range	1-2016. Any band class 5 channel number.
Default:	283				
Range	1-2016. Any band class 5 channel number.				
Web: Primary Channel B UCI: mobile.main.cdma_primary_channel_b Opt: cdma_primary_channel_b	Allows the primary channel (B) to be changed. <table border="1"> <tr> <td>Default:</td> <td>384</td> </tr> <tr> <td>Range</td> <td>1-2016. Any band class 5 channel number.</td> </tr> </table>	Default:	384	Range	1-2016. Any band class 5 channel number.
Default:	384				
Range	1-2016. Any band class 5 channel number.				
Web: Secondary Channel A UCI: mobile.main.cdma_secondary_channel_a Opt: cdma_secondary_channel_a	Allows the secondary channel (A) to be changed. <table border="1"> <tr> <td>Default:</td> <td>691</td> </tr> <tr> <td>Range</td> <td>1-2016. Any band class 5 channel number.</td> </tr> </table>	Default:	691	Range	1-2016. Any band class 5 channel number.
Default:	691				
Range	1-2016. Any band class 5 channel number.				
Web: Secondary Channel B UCI: mobile.main.cdma_secondary_channel_b Opt: cdma_secondary_channel_b	Allows the secondary channel (B) to be changed. <table border="1"> <tr> <td>Default:</td> <td>777</td> </tr> <tr> <td>Range</td> <td>1-2016. Any band class 5 channel number.</td> </tr> </table>	Default:	777	Range	1-2016. Any band class 5 channel number.
Default:	777				
Range	1-2016. Any band class 5 channel number.				
Web: Preferred Forward & Reverse RC UCI: mobile.main.cdma_preferred_forward_and_reverse_rc Opt: cdma_preferred_forward_and_reverse_rc	The preferred forward & reverse RC value, this takes the form "forward_rc,reverse_rc" <table border="1"> <tr> <td>Default:</td> <td>0,0</td> </tr> <tr> <td>Format</td> <td>forward radio channel, reverse radio channel</td> </tr> </table>	Default:	0,0	Format	forward radio channel, reverse radio channel
Default:	0,0				
Format	forward radio channel, reverse radio channel				
Web: SID-NID pairs UCI: mobile.main.cdma_sid_nid_pairs Opt: cdma_sid_nid_pairs	Allows specification of SID:NID pairs, this takes the form "SID1,NID1,SID2,NID2, <table border="1"> <tr> <td>Default:</td> <td>0,0</td> </tr> <tr> <td>Format</td> <td>SID1 (0-65535),NID (0-65535)</td> </tr> </table>	Default:	0,0	Format	SID1 (0-65535),NID (0-65535)
Default:	0,0				
Format	SID1 (0-65535),NID (0-65535)				

Mobile manager: roaming interface template

For more information on Roaming Interface Template configuration, read the chapter, 'Automatic Operator Selection'.

13.1.5. Mobile Manager: Callers

Callers
Configure caller numbers that may use the SMS service.

Name Name of the caller.

Number Number of the caller. Use * for wildcard matching.

Enable

Respond

The mobile manager CDMA page

Web Field/UCI/Package Option	Description				
Web: Name UCI: mobile.@caller[0].name Opt:name	Name assigned to the caller. <table border="1"> <tr> <td>Default:</td> <td>Blank</td> </tr> <tr> <td>Range</td> <td>No limit</td> </tr> </table>	Default:	Blank	Range	No limit
Default:	Blank				
Range	No limit				
Web: Number UCI: mobile.@caller[0].number Opt:number	Number of the caller allowed to SMS the router. Add in specific caller numbers, or use the * wildcard symbol. <table border="1"> <tr> <td>Default:</td> <td>Blank</td> </tr> <tr> <td>Range</td> <td>No limit</td> </tr> </table>	Default:	Blank	Range	No limit
Default:	Blank				
Range	No limit				
Web: Enable UCI: mobile.@caller[0].enabled Opt:enabled	Enables or disables incoming caller ID. <table border="1"> <tr> <td>Default: 0</td> <td>Disabled</td> </tr> <tr> <td>1</td> <td>Enabled</td> </tr> </table>	Default: 0	Disabled	1	Enabled
Default: 0	Disabled				
1	Enabled				
Web: Respond UCI: mobile.@caller[0].respond Opt: respond	If checked, the router will return an SMS. Select Respond if you want the router to reply. <table border="1"> <tr> <td>Default: 0</td> <td>Disabled</td> </tr> <tr> <td>1</td> <td>Enabled</td> </tr> </table>	Default: 0	Disabled	1	Enabled
Default: 0	Disabled				
1	Enabled				

13.2. Configuring Mobile Manager Using UCI

The configuration files for mobile manager are stored on `/etc/config/mobile`

The following example shows how to enable the SMS functionality to receive and respond from certain caller ID numbers.

```
root@VA_router:~# uci show mobile

uci set mobile.main=mobile

uci set mobile.main.sim1pin=0000

uci set mobile.main.sim2pin=0000

uci set mobile.main.sim1_lte_bands='3,20'

uci set mobile.main.sim2_lte_bands='4,5'

uci set mobile.main.temp_poll_interval_sec=61

uci set mobile.main.enable_firmware_autoselect=0

uci set mobile.main.allow_usb_powercycle=1

uci set mobile.main.roaming_sim=none

uci set mobile.main.sms=1

uci set mobile.main.hdr_password=5678

uci set mobile.main.hdr_userid=1234

uci set mobile.main.init_get_iccids=1

uci set mobile.@caller[0]=caller

uci set mobile.@caller[0].name=user1

uci set mobile.@caller[0].number=3538712345678

uci set mobile.@caller[0].enabled=1

uci set mobile.@caller[0].respond=1

uci set mobile.@caller[1]=caller

uci set mobile.@caller[1].name=user2

uci set mobile.@caller[1].number=3538723456789

uci set mobile.@caller[1].enabled=1

uci set mobile.@caller[1].respond=1
```

Mobile manager using package options

```
root@VA_router:~# uci export mobile

package mobile

config mobile 'main'

option sim1pin '0000'

option sim2pin '0000'

option roaming_sim 'none' option sms '1'

option hdr_password '5678'

option hdr_userid '1234'

option init_get_jccids '1'

option sim1_lte_bands '3,20'

option sim2_lte_bands '4,5'

option temp_poll_interval_sec '61'

option enable_firmware_autoselect '0'

option allow_usb_powercycle '1'

config caller

option name 'vasupport' option number '353871234567'

option enabled '1'

option respond '1'

config caller

option name 'vasupport1' option number '353872345678'

option enabled '1'

option respond '1'
```

13.3. Monitoring SMS

You can monitor inbound SMS messages using the router's web browser or via an SSH session

To monitor SMS using the web browser, login and select **Status > system log**. Scroll to the bottom of the log to view the SMS message.

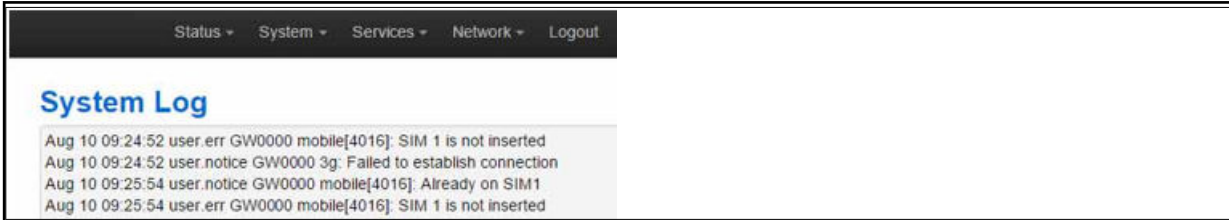

Example of output from system log

To monitor using SSH, login and enter:

```
logread -f &
```

Or, when logging system messages to a flash file at /root/syslog.messages

```
tail -f /root/syslog.messages &
```

13.3.1. Sending SMS From The Router

You can send an outgoing message via the command line using the following syntax:

```
sendsms 353879876543 'hello'  
root@VirtualAccess:~# Aug 10 16:29:1 user:notice VirtualAccess  
mobile[1737]: Queue sms to 353879876543 "hello"
```

13.3.2. Sending SMS To The Router

The router can accept UCI show and set commands via SMS if the caller is enabled.



NOTE

Commands are case sensitive.

An example would be to SMS the SIM card number by typing the following command on the phone and checking the SMS received from the router.

```
uci show mobile.@caller[0].number
```

Multiple commands can be sent in a single SMS using a semicolon (;) separator; for example, to set the router to factory config and then reboot.

```
vacmd set next config factconf;reboot
```

14. Configuring Multi-APNs For Mobile Interfaces

Some of our routers, including the Merlin Series, support simultaneous multiple APN connections to be connected using a single SIM card. Up to two APNs per SIM are currently supported.

Support for this feature is limited to specific mobile modules.

Supported Mobile Modules

Vendor	Module
Quectel	Quectel EC25
SIMCOM	SIMCOM7600E-H

Configuration Package Used

Package	Sections
network	interface

14.1. Multi-APN Overview

A PDP (Packet Data Protocol) context is a data structure that exists within the mobile service provider's network that contains a subscriber's session information when the subscriber has an active session. The PDP context data structure contains:

- the subscriber's IP address,
- IMSI (International Mobile Subscriber Identity), and
- APN (Access Point Name)

It is sometimes required to connect to two different APNs at the same time. This can be achieved with a single SIM card using separate PDP contexts.



NOTE

The SIM card must allow connection to each of the APNs. Also, two PDP contexts from the same SIM card cannot use the same APN.

You can use routing and VRF support for each PDP context by referring to the unique interface name that the APN is configured under. Routing and VRF support can be utilised for each PDP context. For more information on these features, read chapters 'Configuring Static Routes' and 'VRF: Virtual Router Forwarding'.

Multi-WAN can control routing to each PDP context in the same way it can control routing to other interfaces. However, in package multiwan option `manage_state`, set to `no` for both multiwan interface configurations. Multiwan will then control routing through each PDP context by altering the interface metric to '-1' when it determines the interface has failed its health check.

14.2. Configuring Multi-APN Using The Web Interface

To configure Multi-APN, select **Network -> Interface**. A unique PDP context needs to be configured on each mobile interface. For more information on how to configure a mobile interface, read the chapter 'Configuring a mobile connection'.



NOTE

On each mobile interface set **option sim** to the same number and not to **any**.

The screenshot shows the 'Interfaces' section of a network management interface. It features a table with columns for 'Network', 'Status', and 'Actions'. The table lists five interfaces: MOBILE1 (qrimux0), MOBILE2 (qrimux1), LAN (Master 'OpenWiFi'), LOOPBACK (lo), and WLAN (wlan). Each interface row includes its name, status (e.g., 'Uptime: 0h 10m 23s'), and a set of four action buttons: 'Connect', 'Stop', 'Edit', and 'Delete'. The WLAN interface is marked as 'Unsupported protocol type'.

The network interface page

On the the desired mobile interface, select **Edit** and then select **Advanced Settings**.

The screenshot displays the 'Advanced Settings' tab for the MOBILE1 interface. It includes several configuration options: 'Bring up on boot' (checked), 'Monitor interface state' (unchecked), 'Authentication type' set to 'CHAP', 'PDP context' set to '1', 'Enable IPv6 negotiation on the PPP link' (unchecked), 'Modem init timeout' set to '20', 'Use default gateway' (checked), 'Use gateway metric' set to '1', 'IPv4 Mode' set to 'DHCP', and 'IPv6 Mode' set to 'None'. Each option has a help icon and a tooltip.

The mobile interface advanced settings page

Web Field/UCI/Package Option	Description				
Web: PDP context UCI: network.[interface].pdp_context Opt:pdp_context	Defines the PDP context ID. Should multiple active PDP contexts be supported, you must configure interfaces with different PDP context IDs.				
	<table border="1"> <tr> <td>1</td> <td></td> </tr> <tr> <td>Range</td> <td>1-4</td> </tr> </table>	1		Range	1-4
1					
Range	1-4				

14.3. Configuring Multi-APN Using The Command Line

You can configure multi-APN using the interface configuration section in the network package `/etc/config/network` using the option `pdp_context`. The option value should be an integer that is unique to each APN configuration.

14.3.1. Configuring Multi-APN Using UCI

```
root@VA_router:~# uci show network
package network

network.Mobile1=interface
network.Mobile1.proto=3g
network.Mobile1.apn=open.internet
network.Mobile1.username=gprs
network.Mobile1.password=gprs
network.Mobile1.sim=1
network.Mobile1.service=auto
network.Mobile1.metric=1
```

```
network.Mobile1.pdp_context=1
network.Mobile2=interface
network.Mobile2.proto=3g
network.Mobile2.apn=3ireland.ie
network.Mobile2.sim=1
network.Mobile2.service=auto
network.Mobile2.metric=1
network.Mobile2.pdp_context=2
```

Configuring multi-APN using package options

```
root@VA_router:~# uci export
network package network
#####
config interface 'Mobile1'
option proto '3g'
option apn 'open.internet'
option username 'gprs'
option password 'gprs'
option sim '1'
option service 'auto'
option metric '1'
option pdp_context '1'
config interface 'Mobile2'
option proto '3g'
option apn '3ireland.ie'
option sim '1'
option service 'auto'
option metric '1'
option pdp_context '2'
```

Example of simple routing over multi-APN using UCI

```
root@VA_router:~# uci show network
package network
network.Mobile1=interface
network.Mobile1.proto=3g
network.Mobile1.apn=open.internet
network.Mobile1.username=gprs
network.Mobile1.password=gprs
network.Mobile1.sim=1
network.Mobile1.service=auto
network.Mobile1.metric=1
network.Mobile1.pdp_context=1
network.Mobile1.defaultroute=0
network.Mobile2=interface
network.Mobile2.proto=3g
network.Mobile2.apn=3ireland.ie
network.Mobile2.sim=1
network.Mobile2.service=auto
network.Mobile2.metric=1
network.Mobile2.pdp_context=2
network.Mobile1.defaultroute=0
#####
network.8888=route
network.8888.interface=Mobile1
network.8888.target=8.8.8.8
network.8888.netmask=255.255.255.255
network.8844=route
network.8844.interface=Mobile1
network.8844.target=8.8.4.4
network.8844.netmask=255.255.255.255
```

14.4. Multi-APN Diagnostics

Interface Status

When active, to see the status of interfaces with multiple APNs, enter:

```
root@VA_router:~# ifconfig

#####

qmimux0 Link encap:UNSPEC HWaddr 00-00-00-00-00-00-00-00-00-00
inet addr:10.205.77.223 P-t-P:10.205.77.223 Mask:255.255.255.192
inet6 addr: fe80::9bb3:25f7:278c:a8f1/64 Scope:Link
```

```
UP POINTOPOINT RUNNING NOARP MULTICAST MTU:1500 Metric:1

RX packets:5 errors:0 dropped:0 overruns:0 frame:0 TX packets:23 errors:0 dropped:0 overruns:0 carrier:0 collisions:0 txqueuelen:1

RX bytes:1540 (1.5 KiB) TX bytes:3976 (3.8 KiB)

qmimux1 Link encap:UNSPEC HWaddr 00-00-00-00-00-00-00-00-00-00
inet addr:10.209.38.182 P-t-P:10.209.38.182 Mask:255.255.255.252
inet6 addr: fe80::89f2:b5d5:f017:ae91/64 Scope:Link

UP POINTOPOINT RUNNING NOARP MULTICAST MTU:1500 Metric:1

RX packets:94 errors:0 dropped:0 overruns:0 frame:0 TX packets:293 errors:0 dropped:0 overruns:0 carrier:0 collisions:0
txqueuelen:1

RX bytes:9032 (8.8 KiB) TX bytes:20860 (20.3 KiB)
```

To check which mobile interface corresponds to the output from the ifconfig command shown above, enter:

```
root@VA_router:~# network_status -a

Interface: Mobile1

Status: Up

Uptime: 00h 05m 30s

IPv4 addresses: 10.202.187.228/29 MAC address: 00:00:00:00:00:00

Device name: "qmimux0"

Interface: Mobile2

Status: Up

Uptime: 00h 05m 27s

IPv4 addresses: 10.201.206.252/29 MAC address: 00:00:00:00:00:00

Device name: "qmimux1"
```

14.4.1. Routing Table

To check the routing table, enter:

```
root@VA_router:~# ip route
8.8.4.4 via 10.204.5.101 dev qmimux0
8.8.8.8 via 10.204.5.101 dev qmimux0
10.204.5.100/30 dev qmimux0 proto kernel scope link src 10.204.5.102
10.209.38.180/30 dev qmimux1 proto kernel scope link src 10.209.38.182
192.168.100.0/24 dev eth0 proto kernel scope link src 192.168.100.1
192.168.101.0/24 dev wlan0 proto kernel scope link src 192.168.101.1
192.168.101.0/24 dev wlan1 proto kernel scope link src 192.168.101.1
```

15. Configuring A GRE Interface

General Routing Encapsulation (GRE) is a tunnelling protocol used for encapsulation of other communication protocols inside point to point links over IP.

Configuration Packages Used

Package	Sections
network	interface

15.1. Creating A GRE Connection Using The Web Interface

To create GRE interfaces through the web interface, in the top menu, select **Network -> interfaces**.

There are three sections in the interfaces page.

Section	Description
Interface overview	Shows existing interfaces and their status. You can create new, and edit existing, interfaces here.
Port Map	In this section, you can map device ports to Ethernet interfaces. Ports are marked with capital letters starting with 'A'. Type in space-separated port numbers in the port map fields.
ATM Bridges	ATM bridges expose encapsulated Ethernet in AAL5 connections as virtual Linux network interfaces, which can be used in conjunction with DHCP or PPP to dial into the provider network.

In the Interface Overview section, click **Add new interface**. The Create Interface page appears.

The create interface page

Web Field/UCI/Package Option	Description																										
Web: Name of the new interface UCI: network.<if name> Opt: config interface	Assigns a logical name to the GRE tunnel. The network interface section will be assigned this name <if name>. Type the name of the new interface. Allowed characters are A-Z, a-z, 0-9 and _. Must be less than 11 characters.																										
Web: Protocol of the new interface UCI: network.<if name> .proto Opt: proto	Specifies what protocol the interface will operate on. Select GRE . <table border="1" data-bbox="632 461 1370 920"> <thead> <tr> <th>Option</th> <th>Description</th> </tr> </thead> <tbody> <tr> <td>Static</td> <td>Static configuration with fixed address and netmask.</td> </tr> <tr> <td>DHCP Client</td> <td>Address and netmask are assigned by DHCP</td> </tr> <tr> <td>Unmanaged</td> <td>Unspecified</td> </tr> <tr> <td>IPv6-inIPv4 (RFC4213)</td> <td>Used with tunnel brokers</td> </tr> <tr> <td>IPv6-over-IPv4</td> <td>Stateless IPv6 over IPv4 transport</td> </tr> <tr> <td>GRE</td> <td>Generic Routing Encapsulation protocol</td> </tr> <tr> <td>IOT</td> <td></td> </tr> <tr> <td>L2TP</td> <td>Layer 2 Tunnelling Protocol</td> </tr> <tr> <td>PPP</td> <td>Point to Point Protocol</td> </tr> <tr> <td>PPPoE</td> <td>PPP over Ethernet</td> </tr> <tr> <td>PPPoATM</td> <td>PPP over ATM</td> </tr> <tr> <td>LTE/UMTS/GPRS/EV-DO</td> <td>CDMA, UMTS, or GPRS connection using an AT-style 3g modem</td> </tr> </tbody> </table>	Option	Description	Static	Static configuration with fixed address and netmask.	DHCP Client	Address and netmask are assigned by DHCP	Unmanaged	Unspecified	IPv6-inIPv4 (RFC4213)	Used with tunnel brokers	IPv6-over-IPv4	Stateless IPv6 over IPv4 transport	GRE	Generic Routing Encapsulation protocol	IOT		L2TP	Layer 2 Tunnelling Protocol	PPP	Point to Point Protocol	PPPoE	PPP over Ethernet	PPPoATM	PPP over ATM	LTE/UMTS/GPRS/EV-DO	CDMA, UMTS, or GPRS connection using an AT-style 3g modem
Option	Description																										
Static	Static configuration with fixed address and netmask.																										
DHCP Client	Address and netmask are assigned by DHCP																										
Unmanaged	Unspecified																										
IPv6-inIPv4 (RFC4213)	Used with tunnel brokers																										
IPv6-over-IPv4	Stateless IPv6 over IPv4 transport																										
GRE	Generic Routing Encapsulation protocol																										
IOT																											
L2TP	Layer 2 Tunnelling Protocol																										
PPP	Point to Point Protocol																										
PPPoE	PPP over Ethernet																										
PPPoATM	PPP over ATM																										
LTE/UMTS/GPRS/EV-DO	CDMA, UMTS, or GPRS connection using an AT-style 3g modem																										
Web: Create a bridge over multiple interfaces UCI: network.<if name> Opt: n/a	Not applicable for GRE.																										
Create a bridge over multiple interfaces UCI: network.< name> Opt: n/a	Not applicable for GRE.																										

Click **Submit**. The Common Configuration page appears. There are three sections in the Common Configurations page.

Section	Description
General Setup	Configure the basic interface settings such as protocol, IP address, mask length, local interface, remote IP address, TTL, tunnel key and MTU.
Advanced Settings	'Bring up on boot' and 'monitor interface state' settings.
Firewall Settings	Assign a firewall zone to the connection.

15.1.1. GRE Connection: Common Configuration: General Setup

Common Configuration

General Setup [Advanced Settings](#) [Firewall Settings](#)









Status  gre-Tunnel1 RX: 0.00 B (0 Pkts.)
TX: 0.00 B (0 Pkts.)

Protocol:

Tunnel IP Address:

Mask Length:

Local Interface:

- 3G: 
- ADSL: 
- Test_BC: 
- lan: 
- lan2: 
- lan3: 
- lan4: 
- loopback: 
- ethalias: *(no interfaces attached)*

Remote IP Address:

TTL:

Tunnel key:

MTU:

The GRE common configuration page

Web Field/UCI/Package Option	Description				
Web: Protocol of the new interface UCI: network.<if name>.proto Opt: proto	Shows the protocol the interface will operate on . GRE should be currently selected.				
Web: Tunnel IP Address UCI: network.<if name>.ipaddr Opt: ipaddr	Configures local IP address of the GRE interface.				
Web: Mask length UCI: network.<if name> .ipaddr Opt: mask_length	Subnet mask, in CIDR notation, to be applied to the tunnel. Typically '30' for point-to-point tunnels. <table border="1" data-bbox="555 600 694 674"> <tr> <td>Default</td> <td>24</td> </tr> <tr> <td>Range</td> <td>0-30</td> </tr> </table>	Default	24	Range	0-30
Default	24				
Range	0-30				
Web: Local Interface UCI: network. <if name> .remote_ip Opt: local interface	Specifies which interface is going to be linked with the GRE tunnel interface (optional).				
Web: Remote IP address UCI: network. <if name> .remote_ip Opt: remote_ip	For point-to-point tunnels. Specifies remote IP address.				
Web: TTL UCI: network. <if name> .key Opt: key	Sets Time-To-Live value on the interface. <table border="1" data-bbox="555 1025 687 1099"> <tr> <td>Default</td> <td>128</td> </tr> <tr> <td>Range</td> <td></td> </tr> </table>	Default	128	Range	
Default	128				
Range					
Web: Tunnel key UCI: network. <if name> .key Opt: key	Sets GRE tunnel ID key (optional). Usually an integer.				
Web: MTU UCI: nwtwork. <if name> .mtu Opt: mtu	Sets GRE MTU (maximum transmission unit) size of PDUs using this interface. <table border="1" data-bbox="555 1308 699 1382"> <tr> <td>Default</td> <td>1472</td> </tr> <tr> <td>Range</td> <td></td> </tr> </table>	Default	1472	Range	
Default	1472				
Range					

15.1.2. Configuring IPv6 Routes Using The Web Interface

You can also specify IPv6 routes by defining one or more IPv6 routes. In the IPv6 routes section, click **Add**.

Web Field/UCI/Package Option	Description				
Web: Interface UCI: network@route[1].interface Opt: interface	Specifies the logical interface name of the parent or master interface this route belongs to. It must refer to one of the defined interface sections.				
Web: target UCI: network@route[1].target Opt: target	Specifies the route network IP address, or subnet in CIDR notation: Example: 2001:0DB8:100:F00:BA3::1/64				
Web: Gateway UCI: network@route[1].gateway Opt: Gateway	Network gateway. If omitted, the gateway from the parent interface is taken. If set to 0.0.0.0 no gateway will be specified for the route.				
Web: Metric UCI: network@route[1].metric Opt: metric	Specifies the route metric to use. <table border="1"> <tr> <td>Default</td> <td>0</td> </tr> <tr> <td>Range</td> <td></td> </tr> </table>	Default	0	Range	
Default	0				
Range					
Web: MTU UCI: network@route[1].mtu Opt: mtu	Defines a specific MTU for this route. If omitted the MTU from the parent interface will be taken. <table border="1"> <tr> <td>Default</td> <td>Empty</td> </tr> <tr> <td>Range</td> <td></td> </tr> </table>	Default	Empty	Range	
Default	Empty				
Range					

When you have made your changes, click **Save & Apply**.

15.1.3. GRE Connection: Common Configuration-Advanced Settings

Common Configuration

General Setup **Advanced Settings** Firewall Settings

Bring up on boot

Monitor interface state This interface state would be reported to VA Monitor via keep-alive

Dependant interfaces

- GRETUNNEL1:
- MOBILE_amylan:
- MOBILE_voda:
- PoAADSL:
- SUBNET1: (no interfaces attached)
- SUBNET2:
- SUBNET3:
- SUBNET4:
- loopback:

Check interfaces which should start after this interface is started and stop after this interface is stopped

SNMP Alias ifindex: Alias ifindex SNMP agent. Alias indexes are present at 1000 offset. So setting 1 here will create snmp ifTable entry 1001. Useful when interface creates new linux interface on every startup (e.g. ppp interface). With this set the interface could be monitored via constant snmp agent interface table entry

The GRE advanced settings page

Web Field/UCI/Package Option	Description										
Web: Bring up on boot UCI: network.<if name>.auto Opt: auto	Enables the interface to connect automatically on boot up. <table border="1"> <tr> <td>Default: 1</td> <td>Enabled</td> </tr> <tr> <td>0</td> <td>Disabled</td> </tr> </table>	Default: 1	Enabled	0	Disabled						
Default: 1	Enabled										
0	Disabled										
Web: Monitor interface state UCI: network.<if name>.monitored Opt: monitored	Enabled if status of interface is presented on Monitoring platform. <table border="1"> <tr> <td>Default: 1</td> <td>Enabled</td> </tr> <tr> <td>0</td> <td>Disabled</td> </tr> </table>	Default: 1	Enabled	0	Disabled						
Default: 1	Enabled										
0	Disabled										
Web: Dependant Interfaces UCI: network.[..].dependants Opt: dependants	Lists interfaces that are dependant on this parent interface. Dependant interfaces will go down when parent interface is down and will start or restart when parent interface starts. Separate multiple interfaces by a space when using UCI. Example: option dependants 'PPPADSL MOBILE' This replaces the following previous options in child interfaces. <table border="1"> <tr> <td>gre</td> <td>option local_interface</td> </tr> <tr> <td>lt2p</td> <td>option src_ipaddr</td> </tr> <tr> <td>iot</td> <td>option wan1 wan2</td> </tr> <tr> <td>6in4</td> <td>option ipaddr</td> </tr> <tr> <td>6to4</td> <td>option ipaddr</td> </tr> </table>	gre	option local_interface	lt2p	option src_ipaddr	iot	option wan1 wan2	6in4	option ipaddr	6to4	option ipaddr
gre	option local_interface										
lt2p	option src_ipaddr										
iot	option wan1 wan2										
6in4	option ipaddr										
6to4	option ipaddr										
Web: SNMP Alias ifindex UCI: network.[..].snmp_alias_ifindex Opt: snmp_alias_ifindex	Defines a static SNMP interface alias index for this interface, that can be polled via the SNMP interface index (snmp_alias_ifindex+1000). For more information, read the chapter 'Configuring SNMP'. <table border="1"> <tr> <td>Default: Blank</td> <td>No SNP interface alias index</td> </tr> <tr> <td>Range</td> <td>0-4294966295</td> </tr> </table>	Default: Blank	No SNP interface alias index	Range	0-4294966295						
Default: Blank	No SNP interface alias index										
Range	0-4294966295										

15.1.4. GRE Connection: Firewall Settings

Use this section to select the firewall zone you want to assign to this interface.

Select **unspecified** to remove the interface from the associated zone or fill out the create field to define a new zone and attach the interface to it.

The screenshot shows the 'Firewall Settings' tab in a management interface. Under 'Create / Assign firewall-zone', there are three radio button options:

- lan: lan: (selected)
- wan: ADSL: 3G: (selected)
- unspecified -or- create: [text input field]

Below the options is a help message: "Choose the firewall zone you want to assign to this interface. Select unspecified to remove the interface from define a new zone and attach the interface to it." At the bottom of the configuration area are buttons for 'Back to Overview', 'Save & Apply', 'Save', and 'Reset'.

GRE firewall settings

Click **Save and Apply**. This will save the current settings and return you to the Interface Overview page. To configure further settings on the GRE interface select **EDIT** for the relevant GRE interface.

15.1.5. GRE Connection: Adding A Static Route

After you have configured the GRE interface, you must configure a static route, to route the desired traffic over the GRE tunnel. To do this, browse to **Network -> Static Routes**. For more information, read the chapter 'Configuring Static Routes'.

15.2. Configuring GRE Using UCI

GRE using Command Line

The configuration file is stored on `/etc/config/network`.

For the examples below, `tunnel1` is used as the interface logical name.

```
root@VA_router:~# uci show network
network.tunnel1=interface
network.tunnel1.proto=gre
network.tunnel1.monitored=0
network.tunnel1.ipaddr=172.255.255.2
network.tunnel1.mask_length=24
network.tunnel1.local_interface=wan
network.tunnel1.remote_ip=172.255.255.100
network.tunnel1.ttl=128
network.tunnel1.key=1234
network.tunnel1.mtu=1472
network.tunnel1.auto=1
```

GRE Configuration using Package Options

```
root@VA_router:~# uci export network
config interface 'tunnel1'
option proto 'gre'
option monitored '0'
option ipaddr '172.255.255.2'
option mask_length '24'
option local_interface 'wan'
option remote_ip '172.255.255.100'
option ttl '128'
option key '1234'
option mtu '1472'
option auto '1'
```

To change any of the above values use `uci set` command.

To show the current running interfaces, enter:

```
root@VA_router:~# ifconfig

base0
Link encap:Ethernet HWaddr 00:00:00:00:01:01
inet6 addr: fe80::200:ff:fe00:101/64 Scope:Link
UP BROADCAST RUNNING MULTICAST MTU:1504 Metric:1
RX packets:39810 errors:0 dropped:0 overruns:0 frame:0 TX packets:365 errors:0 dropped:0 overruns:0 carrier:0 collisions:0
txqueuelen:1000
RX bytes:10889090 (10.3 MiB) TX bytes:68820 (67.2 KiB)

eth4
Link encap:Ethernet HWaddr 00:1E:10:1F:00:00
inet addr:10.68.66.54 Bcast:10.68.66.55 Mask:255.255.255.252
inet6 addr: fe80::21e:10ff:fe1f:0/64 Scope:Link
UP BROADCAST RUNNING MULTICAST MTU:1500 Metric:1
RX packets:81 errors:0 dropped:0 overruns:0 frame:0 TX packets:127 errors:0 dropped:0 overruns:0 carrier:0 collisions:0
txqueuelen:1000
RX bytes:8308 (8.1 KiB) TX bytes:12693 (12.3 KiB)

gre-Tunnel1 Link encap:UNSPEC HWaddr 0A-44-42-36-DB-B0-00-48-00-00-00-00- 00-00-00-00
inet addr:13.13.13.2 Mask:255.255.255.248
inet6 addr: fe80::5efe:a44:4236/64 Scope:Link UP RUNNING MULTICAST MTU:1472 Metric:1
RX packets:7 errors:0 dropped:0 overruns:0 frame:0 TX packets:7 errors:0 dropped:0 overruns:0 carrier:0 collisions:0 txqueuelen:0
RX bytes:912 (912.0 B) TX bytes:884 (884.0 B)

lo
Link encap:Local Loopback
inet addr:127.0.0.1 Mask:255.0.0.0 inet6 addr: ::1/128 Scope:Host
```

```
UP LOOPBACK RUNNING MTU:16436 Metric:1
RX packets:1465 errors:0 dropped:0 overruns:0 frame:0 TX packets:1465 errors:0 dropped:0 overruns:0 carrier:0 collisions:0
txqueuelen:0
RX bytes:166202 (162.3 KiB) TX bytes:166202 (162.3 KiB)
```

To display a specific GRE interface, enter `ifconfig gre-<if name>`:

```

root@VA_router:~# ifconfig gre-Tunnel1

gre-Tunnel1 Link encap:UNSPEC HWaddr 0A-44-42-36-00-00-7F-E2-00-00-00- 00-00-00-00-00
inet addr:13.13.13.2 Mask:255.255.255.248
inet6 addr: fe80::5efe:a44:4236/64 Scope:Link UP RUNNING MULTICAST MTU:1472 Metric:1
RX packets:7 errors:0 dropped:0 overruns:0 frame:0 TX packets:7 errors:0 dropped:0 overruns:0 carrier:0 collisions:0 txqueuelen:0
RX bytes:912 (912.0 B) TX bytes:8GRE route status

```

To show the current GRE route status, enter:

```

root@VA_router:~# route -n

```

Kernel IP routing table							
Destination	Gateway	Genmask	Flags	Metric	Ref	Use	Iface
0.0.0.0	10.68.66.53	0.0.0.0	UG	0	0	0	eth4
0.0.0.0	13.13.13.1	0.0.0.0	UG	1	0	0	0 gre-Tunnel1
10.68.66.52	0.0.0.0	255.255.255.252	U	0	0	0	eth4
13.13.13	.0 0.0.0.0	255.255.255.248	U	0	0	0	gre-Tunnel1
172.19.101.3	13.13.13.1	255.255.255.255	UGH	0	0	0	gre-Tunnel1



NOTE

A GRE route will only be displayed in the routing table when the interface is up.

15.3. GRE Diagnostics

GRE Interface Status

To show the current running interfaces, enter:

```
root@VA_router:~# ifconfig

base0 Link encap:Ethernet HWAddr 00:00:00:00:01:01
inet6 addr: fe80::200:ff:fe00:101/64 Scope:Link
UP BROADCAST RUNNING MULTICAST MTU:1504 Metric:1
RX packets:39810 errors:0 dropped:0 overruns:0 frame:0
TX packets:365 errors:0 dropped:0 overruns:0 carrier:0
collisions:0 txqueuelen:1000
RX bytes:10889090 (10.3 MiB) TX bytes:68820 (67.2 KiB)

eth4 Link encap:Ethernet HWAddr 00:1E:10:1F:00:00
inet addr:10.68.66.54 Bcast:10.68.66.55 Mask:255.255.255.252
inet6 addr: fe80::21e:10ff:fe1f:0/64 Scope:Link
UP BROADCAST RUNNING MULTICAST MTU:1500 Metric:1
RX packets:81 errors:0 dropped:0 overruns:0 frame:0
TX packets:127 errors:0 dropped:0 overruns:0 carrier:0
collisions:0 txqueuelen:1000
RX bytes:8308 (8.1 KiB) TX bytes:12693 (12.3 KiB)

gre-Tunnel1 Link encap:UNSPEC HWAddr 0A-44-42-36-DB-B0-00-48-00-00-00-00- 00-00-00-00
inet addr:13.13.13.2 Mask:255.255.255.248
inet6 addr: fe80::5efe:a44:4236/64 Scope:Link
UP RUNNING MULTICAST MTU:1472 Metric:1
RX packets:7 errors:0 dropped:0 overruns:0 frame:0
TX packets:7 errors:0 dropped:0 overruns:0 carrier:0
collisions:0 txqueuelen:0
RX bytes:912 (912.0 B) TX bytes:884 (884.0 B)

lo Link encap:Local Loopback
inet addr:127.0.0.1 Mask:255.0.0.0
inet6 addr: ::1/128 Scope:Host
UP LOOPBACK RUNNING MTU:16436 Metric:1
RX packets:1465 errors:0 dropped:0 overruns:0 frame:0
TX packets:1465 errors:0 dropped:0 overruns:0 carrier:0
collisions:0 txqueuelen:0
RX bytes:166202 (162.3 KiB) TX bytes:166202 (162.3 KiB)
```

To display a specific GRE interface, enter `ifconfig gre-<if name>`:

```

root@VA_router:~# ifconfig gre-Tunnel1
gre-Tunnel1 Link encap:UNSPEC HWaddr 0A-44-42-36-00-00-7F-E2-00-00-00- 00-00-00-00-00
inet addr:13.13.13.2 Mask:255.255.255.248
inet6 addr: fe80::5efe:a44:4236/64 Scope:Link
UP RUNNING MULTICAST MTU:1472 Metric:1
RX packets:7 errors:0 dropped:0 overruns:0 frame:0
TX packets:7 errors:0 dropped:0 overruns:0 carrier:0
collisions:0 txqueuelen:0
RX bytes:912 (912.0 B) TX bytes:8GRE route status

```

To show the current GRE route status, enter:

```

root@VA_router:~# route -n
Kernel IP routing table

```

Destination	Gateway	Genmask	Flags	Metric	Ref	Use	Iface
0.0.0.0	10.68.66.53	0.0.0.0	UG	0	0	0	eth4
0.0.0.0	13.13.13.1	0.0.0.0	UG	1	0	0	0 gre-Tunnel1
10.68.66.52	0.0.0.0	255.255.255.252	U	0	0	0	eth4
13.13.13	.0 0.0.0.0	255.255.255.248	U	0	0	0	gre-Tunnel1
172.19.101.3	13.13.13.1	255.255.255.255	UGH	0	0	0	gre-Tunnel1

Note: a GRE route will only be displayed in the routing table when the interface is up.

16. Configuring VRF (Virtual Router Forwarding)

Virtual Routing and Forwarding (VRF) is a technology that allows multiple instances of a routing table to exist in a router and work simultaneously. Traffic between routing tables is segregated and so increases security.

VRF overview

An interface is configured to belong to a VRF. Interfaces included in the VRF form an independent routing domain, so routing of incoming and outgoing packets only happens within a VRF. It is also possible to add individual routes to a VRF using static routes.

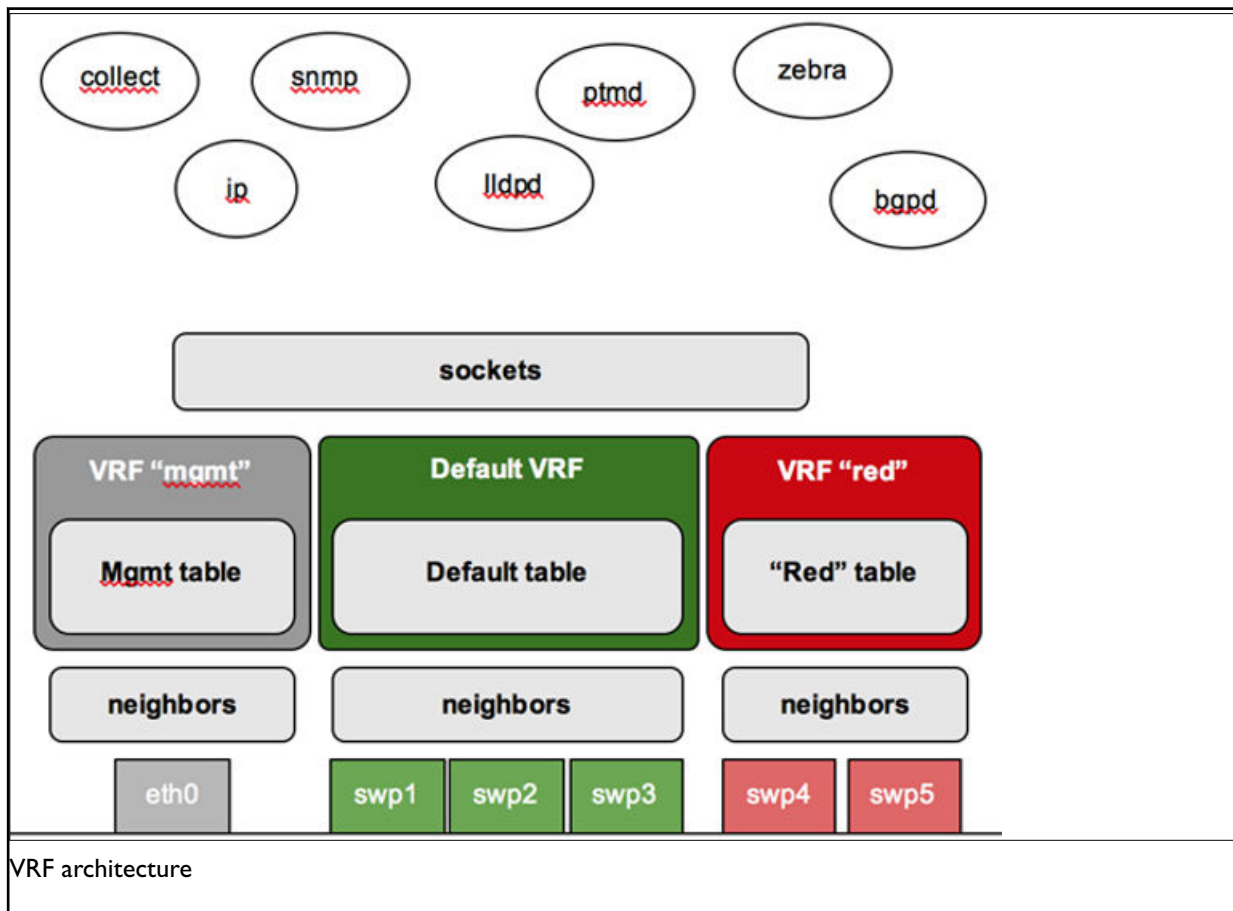

Configuration package used

Package	Sections
network	interface
	route

16.1. Configuring VRF Using The Web Interface

Setting the VRF for an Interface

To create VRFs, you must add interfaces. To add an interface to a VRF instance, select **Network - > Interfaces**, select the desired interface to edit then select **Common Configuration - > Advanced Settings**.

Enter in the relevant VRF name in the VRF field.

WLAN MOBILE2 MOBILE LAN

Interfaces - LAN

On this page you can configure the network interfaces. You can bridge several interfaces by ticking the "bridge interfaces" field and enter the names of spaces. You can also use VLAN notation `INTERFACE.VLANNR` (e.g.: `eth0.1`).

Common Configuration

General Setup Advanced Settings Physical Settings Firewall Settings

Bring up on boot

Monitor interface state [This interface state would be reported to VA Monitor via keep-alive](#)

Override MAC address

Override MTU

Use gateway metric

Dependant interfaces:

- Mobile:
- Mobile2:
- lan:
- loopback:
- wlan: (no interfaces attached)

[Check interfaces which should start after this interface is started and stop after this interface is stopped](#)

SNMP Alias ifIndex [Alias ifIndex for SNMP agent. Alias indexes are present at 1000 offset. So setting 1 h 1001. Useful when interface creates new linux interface on every startup \(e.g. ppp interface\). With this set the interface could be interface table entry](#)

SNMP Alias ifDescr [Alias ifDescr for SNMP agent. Allows to specify a custom ifDescr string](#)

VRF [Assign interface to this VRF](#)

The interfaces configuration page

Web Field/UCI/Package Option	Description				
Web: VRF	Defines the VRF name to which this interface belongs.				
UCI: network.<if name>.vrf	Note: the name must be consistent across all interfaces that want to reside on that VRF.				
Opt: vrf	<table border="1"> <tr> <td>(empty)</td> <td>Interface is not attached to a VRF</td> </tr> <tr> <td>Range</td> <td>0-15 characters</td> </tr> </table>	(empty)	Interface is not attached to a VRF	Range	0-15 characters
(empty)	Interface is not attached to a VRF				
Range	0-15 characters				

To add additional interfaces to a VRF, repeat the above for the relevant interface(s).

For example, the above configuration creates a VRF on a LAN interface. To configure this VRF to be used by traffic from a camera on a LAN interface to a VRF on a mobile interface, repeat the above instructions for a mobile interface so the camera VRF will now contain a local network and mobile interface to route traffic.



NOTE

The default VRF is created automatically and is not assigned any VRF name. It is recommended to use this default VRF to access router services and applications; for example, HTTP, SSH, SNMP etc.

16.1.1. Configuring A VRF On A Static Route

Each VRF has its own routing table and static routes can be added to a VRF routing table. To define a static route on a VRF, select **Network - >Static Routes**.

The static routes configuration page

Web Field/UCI/Package Option	Description
Web: VRF	Defines the VRF name.
UCI: network.route.vrf	Note: 'none' is a special name to move a route out of a VRF.
Opt: vrf	Example: network.route.vrf=none
	(empty) Interface is not attached to a VRF
	Range 0-15 characters

16.2. Configuring The VRFs Using The Command Line

You configure a VRF using the interface configuration section in the network etc/config/network.

The VRF name must be consistent across all interfaces that want to reside on that VRF.

For the command line examples below, two VRFs called Camera and Management are configured.

VRF using UCI

```
root@VA_router:~# uci show network | grep vrf
network.lan.vrf=Camera
network.Mobile1.vrf=Camera
network.Mobile2.vrf=Management
```

VRF using Package Options

```
root@VA_router:~# uci export network
package network
config interface lan
option vrf 'Camera'
config interface Mobile1
option vrf 'camera'
config interface Mobile2
option vrf 'Management'
```

16.2.1. VRF Using UCI

```
root@VA_router:~# uci show network | grep vrf network.lan.vrf=Camera network.Mobile1.vrf=Camera
network.Mobile2.vrf=Management
```

VRF using Package Options

```
root@VA_router:~# uci export network package network
config interface lan
option vrf 'Camera'
config interface Mobile1
```

```
option vrf 'Camera'
config interface Mobile2
option vrf 'Management'
```

To display a list of running VRFs, enter:

```
root@VA_router:~# ip vrf Name Table
Management 10
Camera 10
```

16.3. VRF Diagnostics

To display a list of running VRFs, enter:

```
root@VA_router:~# ip vrf
Name Table
-----
Management 10
Camera 10
```

VRF Table

To display the routing table for a VRF, enter the command:

```
ip router list vrf <vrf name>
```

VRF Routes

To display the routing table for a VRF, enter the command:

```
ip route list vrf <vrf name>.
```

```
root@VA_router:~# ip route list vrf Camera
default via 10.92.163.130 dev qmimux0
10.92.163.128/30 dev qmimux0 proto kernel scope link src 10.92.163.129
172.16.100.0/24 dev eth1 proto kernel scope link src 172.16.100.1
root@VA_router:~# ip route list vrf Management
default via 10.176.120.94 dev qmimux1
10.176.120.92/30 dev qmimux1 proto kernel scope link src 10.176.120.93
```

17. Configuring Static Routes

It is possible to define arbitrary IPv4 routes on specific interfaces using route sections. As for aliases, multiple sections can be attached to an interface. These types of routes are most commonly known as static routes.

You can add static routes to the routing table to forward traffic to specific subnets when dynamic routing protocols are not used or they are not configured for such subnets.

They can be created based on an outgoing interface or next hop IP address.

Configuration Package Used

Package	Sections
network	router

17.1. Configuring Static Routes Using The Web Interface

In the top menu, select Network -> Static Routes. The Routes page appears.

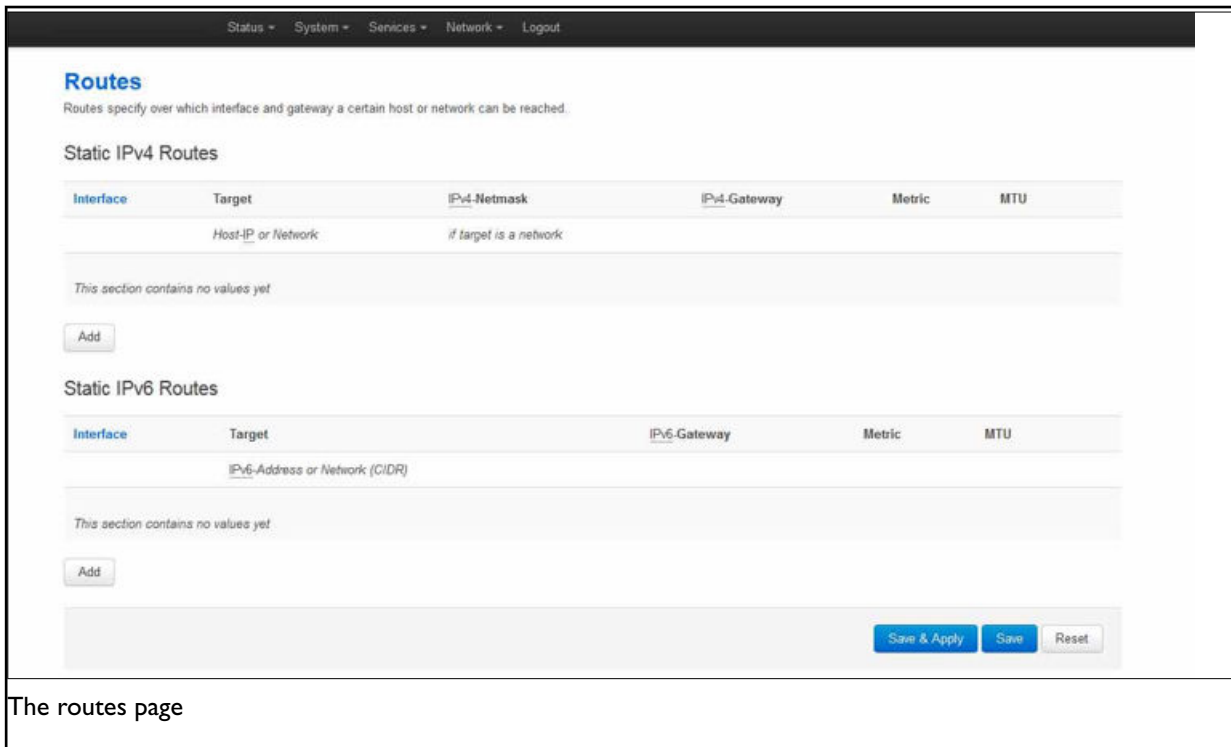

In the IPv4 Routes section , click **Add**.

Web Field/UCI/Package Option	Description				
Web: Interface UCI: network.@route[0].interface Opt: interface	Specifies the logical interface name of the parent or master interface this route belongs to. It must refer to one of the defined interface sections.				
Web: target UCI: network.@router[0].target Opt: target	Specifies the route network IP address.				
Web: netmask UCI: network.@route[0].netmask Opt: netmask	Defines the route netmask. If omitted, 255.255.255.255 is assumed, which makes the target a host address.				
Web: Gateway UCI: network.@route[0].gateway Opt: Gateway	Network gateway. If omitted, the gateway from the parent interface is taken. If set to 0.0.0.0 no gateway will be specified for the route.				
Web: Metric UCI: network.@route[0].metric Opt: metric	Specifies the route metric to use. <table border="1" data-bbox="555 860 668 931"> <tr> <td>Default</td> <td>0</td> </tr> <tr> <td>Range</td> <td></td> </tr> </table>	Default	0	Range	
Default	0				
Range					
Web: MTU UCI: network.@route[0].mtu Opt:mtu	Defines a specific MTU for this route. If omitted, the MTU from the parent interface will be taken. <table border="1" data-bbox="555 1025 699 1097"> <tr> <td>Default</td> <td>Blank</td> </tr> <tr> <td>Range</td> <td></td> </tr> </table>	Default	Blank	Range	
Default	Blank				
Range					

17.2. Configuring Routes Using Command Line

By default all routes are named 'route', it is identified by @route then the route's position in the package as a number. For example, for the first route in the package using UCI:

```
network.@route[0]=route
network.@route[0].interface=lan
```

Or using package options:

```
config route
option 'interface' 'lan'
```

However, you can give a route a name if desired. For example, a route named 'myroute' will be: `network.myroute`.

To define a named route using UCI, enter:

```
network.name_your_route=route
network.name_your_route.interface=lan
```

To define a named route using package options, enter:

```
config route 'name_your_route'  
option 'interface' 'lan'
```

17.3. IPv4 Routes Using UCI

The command line example routes in the subsections below do not have a configured name.

```
root@VA_router:~# uci show network  
network.@route[0]=route  
network.@route[0].interface=lan  
network.@route[0].target=3.3.3.10  
network.@route[0].netmask=255.255.255.255  
network.@route[0].gateway=10.1.1.2  
network.@route[0].metric=3  
network.@route[0].mtu=1400
```

IPv4 Routes using Package Options

```
root@VA_router:~# uci export network  
package network  
  
config route  
option interface 'lan'  
option target '2.2.2.2'  
option netmask '255.255.255.255'  
option gateway '192.168.100.1'  
option metric '1'  
option mtu '1500'
```

17.4. IPv6 Routes Using UCI

```
root@VA_router:~# uci show network  
network.@route[1]=route  
network.@route[1].interface=lan  
network.@route[1].target=2001:0DB8:100:F00:BA3::1/64  
network.@route[1].gateway=2001:0DB8:99::1  
network.@route[1].metric=1  
network.@route[1].mtu=1500
```

IPv6 routers using Package Options

```

root@VA_router:~# uci export network
package network

config route

option interface 'lan'
option target '2001:0DB8:100:F00:BA3::1/64'
option gateway '2001:0DB8:99::1'
option metric '1'
option mtu '1500'

```

17.5. Static Routes Diagnostics

To show the current routing status, enter:

Root@VA_router:~# route							
Kernel IP routing table							
Destination	Gateway	Genmask	Flags	Metric	Ref	Use	Iface
192.168.100.1	*	255.255.255.0	0	0	0	0	eth 0



NOTE

A route will only be displayed in the routing table when the interface is up.

17.6. Configuring IPv6 Routes Using The Web Interface

You can also specify IPv6 routes by defining one or more IPv6 routes. In the IPv6 routes section, click **Add**.

Web Field/UCI/Package Option	Description				
Web: Interface UCI: network.@route[1].interface Opt: interface	Specifies the logical interface name of the parent or master interface this route belongs to. It must refer to one of the defined interface sections.				
Web: target UCI: network.@route[1].target Opt: target	Specifies the route network IP address, or subnet in CIDR notation: Example: 2001:0DB8:100:F00:BA3::1/64				
Web: Gateway UCI: network.@route[1].gateway Opt: Gateway	Network gateway. If omitted, the gateway from the parent interface is taken. If set to 0.0.0.0 no gateway will be specified for the route.				
Web: Metric UCI: network.@route[1].metric Opt: metric	Specifies the route metric to use. <table border="1"> <tr> <td>Default</td> <td>0</td> </tr> <tr> <td>Range</td> <td></td> </tr> </table>	Default	0	Range	
Default	0				
Range					
Web: MTU UCI: network.@route[1].mtu Opt: mtu	Defines a specific MTU for this route. If omitted the MTU from the parent interface will be taken. <table border="1"> <tr> <td>Default</td> <td>Empty</td> </tr> <tr> <td>Range</td> <td></td> </tr> </table>	Default	Empty	Range	
Default	Empty				
Range					

When you have made your changes, click **Save & Apply**.

18. Configuring BGP (Border Gateway Protocol)

BGP is a protocol for exchanging routing information between gateway hosts, each with its own router, in a network of autonomous systems. BGP is often the protocol used between gateway hosts on the internet. The routing table contains a list of known routers, the addresses they can reach, and a cost metric associated with the path to each router so that the best available route is chosen.

Configuration package used

Package	Sections
bgpd	routing
	peer
	routemap

18.1. Configuring BGP Using The Web Interface

In the top menu, select **Network -> BGP**. The BGP configuration page appears.

The page has three sections: Global Settings, BGP Neighbours and BGP Route Map.

The BGP page

BGP Global Settings

To configure global BGP settings, click **Add**. The Global Settings page appears.

BGP

Global Settings

BGP Enabled

Router ID

Scan Time ⓘ *The interval in seconds between RIB scans*

Autonomous System
Number

Log keepalives

Log events

Log filters

Log fsm

Log updates

Network ⓘ

ⓘ *These networks will be announced to neighbours*

The BGP global settings page

Web Field/UCI/Package Option	Description				
Web: BGP Enabled UCI: bgpd.bgpd.enabled Opt: enabled	Enables or disables BGP protocol. <table border="1"> <tr> <td>Default: 0</td> <td>Disabled</td> </tr> <tr> <td>1</td> <td>Enabled</td> </tr> </table>	Default: 0	Disabled	1	Enabled
Default: 0	Disabled				
1	Enabled				
Web: Router ID UCI: bgpd.bgpd.router_id Opt: router_id	Sets a unique router ID in 4 byte format 0.0.0.0.				
Web: Scan Time UCI: bgpd.bgpd.scan_time Opt: scan_time	Defines the interval in seconds between RIB scans. <table border="1"> <tr> <td>Default</td> <td>60 seconds</td> </tr> <tr> <td>Range</td> <td></td> </tr> </table>	Default	60 seconds	Range	
Default	60 seconds				
Range					
Web: Autonomous System Number UCI: bgpd.bgpd.asn Opt: asn	Defines the ASN for the local router. Type in the ASN. <table border="1"> <tr> <td>Default</td> <td>Blank</td> </tr> <tr> <td>Range</td> <td>1-4294967295</td> </tr> </table>	Default	Blank	Range	1-4294967295
Default	Blank				
Range	1-4294967295				
Web: Log keepalives UCI: bgpd.bgpd.debug_keepalive Opt: debug_keepalives	Defines whether to enable BGP keepalives to the system log. <table border="1"> <tr> <td>Default: 0</td> <td>Disabled</td> </tr> <tr> <td>1</td> <td>Enabled</td> </tr> </table>	Default: 0	Disabled	1	Enabled
Default: 0	Disabled				
1	Enabled				
Web: Log events UCI: bgpd.bgpd.debug_events Opt: debug_events	Defines whether to enable BGP event to the system log. <table border="1"> <tr> <td>Default: 0</td> <td>Disabled</td> </tr> <tr> <td>1</td> <td>Enabled</td> </tr> </table>	Default: 0	Disabled	1	Enabled
Default: 0	Disabled				
1	Enabled				
Web: Log filters UCI: bgpd.bgpd.debug_filters Opt: debug_filters	Defines whether to enable BGP filter events to the system log. <table border="1"> <tr> <td>Default: 0</td> <td>Disabled</td> </tr> <tr> <td>1</td> <td>Enabled</td> </tr> </table>	Default: 0	Disabled	1	Enabled
Default: 0	Disabled				
1	Enabled				
Web: Log fsm UCI: bgpd.bgpd.debug_fsm Opt: debug_fsm	Defines whether to enable BGP state changes to the system log. <table border="1"> <tr> <td>Default: 0</td> <td>Disabled</td> </tr> <tr> <td>1</td> <td>Enabled</td> </tr> </table>	Default: 0	Disabled	1	Enabled
Default: 0	Disabled				
1	Enabled				
Web: Log Updates UCI: bgpd.bgpd.debug_updates Opt: debug_updates	Defines whether to enable BGP updates to the system log. <table border="1"> <tr> <td>Default: 0</td> <td>Disabled</td> </tr> <tr> <td>1</td> <td>Enabled</td> </tr> </table>	Default: 0	Disabled	1	Enabled
Default: 0	Disabled				
1	Enabled				
Web: Network UCI: bgpd.bgpd.network Opt: list network	Sets the list of networks that will be advertised to neighbours in prefix format 0.0.0.0/0. Separate multiple networks by a space using UCI. Ensure the network prefix matches the one shown in the routing table. For more information, read the 'Routes' section below.				
Web: n/a UCI: bgpd.bgpd.vrf Opt: vrf	Defines the VRF with which to associate this BGP routing instance.				

18.2. Optionally Configure A BGP Route Map

Route maps provide a means to both filter and/or apply actions to a route. This allows a policy to be applied to routes. Route maps are an ordered list of route map entries each with a set of criteria that must be matched before specific attributes of the route are modified.

Scroll down to the BGP Route Map section.

Type in a name for the BGP route map name and then click **Add**. The BGP Route Map configuration section appears. You can configure multiple route maps. The examples below are for a route map named ROUTEMAP.

ROUTEMAP	
Order	<input type="text" value="10"/>
Policy Type	<input type="text" value="Permit"/>
Match Type	<input type="text" value="IP Address"/>
Match Value	<input type="text" value="192.168.101.1/32"/> ⓘ <small>Format depends on Match Type. In case of IP Address and BGP Community value is parsed as list of items to match. Use ':' prefix to deny match</small>
Set Option	<input type="text" value="Route Weight"/>
Set Value	<input type="text" value="150"/>

The route map section

Web: Match Type	Defines match type. Available options are as follows:																		
Web: Order UCI: bgpd.ROUTEMAP.order Opt: order	Defines the route map order number. <table border="1"> <tr> <td>Default</td> <td>Blank</td> </tr> <tr> <td>Range</td> <td>1-65535</td> </tr> </table>	Default	Blank	Range	1-65535														
Default	Blank																		
Range	1-65535																		
Web: Policy Type UCI: bgpd.ROUTEMAP.permit Opt: permit	Defines the actions taken if the entry is matched. <table border="1"> <tr> <td>Default: Permit</td> <td>Permits the route to process the set actions for this entry.</td> </tr> <tr> <td>Deny</td> <td>Denies the route.</td> </tr> </table>	Default: Permit	Permits the route to process the set actions for this entry.	Deny	Denies the route.														
Default: Permit	Permits the route to process the set actions for this entry.																		
Deny	Denies the route.																		
UCI: bgpd.ROUTEMAP.match_type Opt: match_type	Defines match type. Available options are as follows: <table border="1"> <tr> <td>IP address</td> <td>Matches IP address</td> </tr> <tr> <td>IP Next Hop</td> <td>Matches next hop IP address</td> </tr> <tr> <td>AS-Path</td> <td>Matches AS path</td> </tr> <tr> <td>Route Metric</td> <td>Matches route metric</td> </tr> <tr> <td>BGP Community</td> <td>Matches BGP community</td> </tr> </table>	IP address	Matches IP address	IP Next Hop	Matches next hop IP address	AS-Path	Matches AS path	Route Metric	Matches route metric	BGP Community	Matches BGP community								
IP address	Matches IP address																		
IP Next Hop	Matches next hop IP address																		
AS-Path	Matches AS path																		
Route Metric	Matches route metric																		
BGP Community	Matches BGP community																		
Web: Match value UCI: bgpd.ROUTEMAP.match Opt: match	Defines the value of the match type. Format depends on the match type selected. In the case of IP address and BGP Community values, the match value is parsed as a list of items to match. Enter '-' prefix to deny match.																		
Web: Set Option UCI: bgpd.ROUTEMAP.set_type Opt: set_type	Defines the set option to be processed on a match. Available options are shown below. <table border="1"> <tr> <td>None</td> <td></td> </tr> <tr> <td>IP Next Hop</td> <td>Setting option for IP next hop.</td> </tr> <tr> <td>Local Preference</td> <td>Setting option for Local Preference</td> </tr> <tr> <td>Router Weight</td> <td>Setting option for Route Weight</td> </tr> <tr> <td>BGP MED</td> <td>Setting option for BGP multi-exit discriminator (BGP metric)</td> </tr> <tr> <td>AS Path to Prepend</td> <td>Setting option to prepend AS to AS path</td> </tr> <tr> <td>BGP Community</td> <td>Setting option for BGP community</td> </tr> <tr> <td>IPv6 Next Hop</td> <td>Setting option for IPv6 Next Hop Global</td> </tr> <tr> <td>IPv6 Next Hop Local</td> <td>Setting option for IPv6 Next Hop Local</td> </tr> </table>	None		IP Next Hop	Setting option for IP next hop.	Local Preference	Setting option for Local Preference	Router Weight	Setting option for Route Weight	BGP MED	Setting option for BGP multi-exit discriminator (BGP metric)	AS Path to Prepend	Setting option to prepend AS to AS path	BGP Community	Setting option for BGP community	IPv6 Next Hop	Setting option for IPv6 Next Hop Global	IPv6 Next Hop Local	Setting option for IPv6 Next Hop Local
None																			
IP Next Hop	Setting option for IP next hop.																		
Local Preference	Setting option for Local Preference																		
Router Weight	Setting option for Route Weight																		
BGP MED	Setting option for BGP multi-exit discriminator (BGP metric)																		
AS Path to Prepend	Setting option to prepend AS to AS path																		
BGP Community	Setting option for BGP community																		
IPv6 Next Hop	Setting option for IPv6 Next Hop Global																		
IPv6 Next Hop Local	Setting option for IPv6 Next Hop Local																		
Web: Value UCI: bgpd.ROUTEMAP.set Opt: set	Defines the set value when a match occurs. Value format depends on the set option you have selected.																		
Web: n/a UCI: bgpd.ROUTEMAP.routing Opt: set	Defines the routing section this BGP route map is related to.																		

18.3. Configure BGP Neighbours

To configure BGP neighbours, in the BGP neighbours section, click **Add**. The BGP Neighbours page appears. You can configure multiple BGP neighbours.

BGP Neighbours

IP Address	Autonomous System Number	Route Map	Route Map Direction	IPv6	Local Peer	Holdtime	Keepalive Interval	Connect Timer
<input type="text" value="11.11.11.1"/>	<input type="text" value="2"/>	<input type="text"/>	In ▾	<input type="checkbox"/>	<input type="checkbox"/>	seconds <input type="text"/>	seconds <input type="text"/>	seconds <input type="text"/>

The BGP neighbours section

Web Field/UCI/Package Option	Description				
Web: IP Address UCI: bgpd.@peer[0].ipaddr Opt: ipaddr	Sets the IP address of the neighbour.				
Web: Autonomous System Number UCI: bgpd.@peer[0].asn Opt: asn	Sets the ASN of the remote peer. <table border="1"> <tr> <td>Default</td> <td>Blank</td> </tr> <tr> <td>Range</td> <td>1-4294967295</td> </tr> </table>	Default	Blank	Range	1-4294967295
Default	Blank				
Range	1-4294967295				
Web: Route Map UCI: bgpd.@peer[0].route_map Opt: route_map	Sets route map name to use with this neighbour.				
Web: Route Map Direction UCI: bgpd.@peer[0].route_map_in Opt: route_map_in	Defines what direction to apply to the route map. <table border="1"> <tr> <td>Default: 1</td> <td>In</td> </tr> <tr> <td>0</td> <td>Out</td> </tr> </table>	Default: 1	In	0	Out
Default: 1	In				
0	Out				
Web: IPv6 UCI: bgpd.@peer[0].ipv6 Opt: ipv6	Defines whether the peer is connected over IPv6. <table border="1"> <tr> <td>Default</td> <td>0</td> </tr> <tr> <td></td> <td>1</td> </tr> </table>	Default	0		1
Default	0				
	1				
Web: Local Peer UCI: bgpd.@peer[0].next_hop_self Opt: next_hop_self	Defines an announced route's next hop as being equivalent to the address of the router if it is learned via BGP. <table border="1"> <tr> <td>Default</td> <td>0</td> </tr> <tr> <td></td> <td>1</td> </tr> </table>	Default	0		1
Default	0				
	1				
Web: Holdtime UCI: bgpd.@peer[0].holdtime_sec Opt: holdtime_sec	Defines how long to wait for incoming BGP messages before assuming peer is dead. The timer is reset every time a BGP message is received. <table border="1"> <tr> <td>Default</td> <td>0</td> </tr> <tr> <td>Range</td> <td></td> </tr> </table>	Default	0	Range	
Default	0				
Range					
Web: Keepalive Interval UCI: bgpd.@peer[0].keepalive_sec Opt: keepalive_sec	Defines the interval in seconds for between two successive BGP keep alive messages. <table border="1"> <tr> <td>Default</td> <td>0</td> </tr> <tr> <td>Range</td> <td></td> </tr> </table>	Default	0	Range	
Default	0				
Range					
Web: Connect Timer UCI: bgpd.@peer[0].connect_sec Opt: connect_sec	Defines how long to wait after interface is up before retrying the connection on it. <table border="1"> <tr> <td>Default</td> <td>0</td> </tr> <tr> <td>Range</td> <td></td> </tr> </table>	Default	0	Range	
Default	0				
Range					
Web: n/a UCI: bgpd.@peer[0].routing Opt: routing	Defines the routing section this BGP peer is related to.				

18.4. Configuring BGP Using Command Line

Configuring BGP using UCI

You can configure BGP using UCI. The configuration file is stored on:

`/etc/config/bgpd`

```
root@VA_router:~# uci show bgpd
bgpd.bgpd=routing
bgpd.bgpd.enabled=yes
bgpd.bgpd.router_id=3.3.3.3
bgpd.bgpd.asn=1
bgpd.bgpd.network=11.11.11.0/29 192.168.103.1/32
bgpd.bgpd.vrf=datavrf
bgpd.@peer[0]=peer
bgpd.@peer[0].route_map_in=yes
bgpd.@peer[0].ipaddr=11.11.11.1
bgpd.@peer[0].asn=1
bgpd.@peer[0].route_map=ROUТЕMAP
bgpd.@peer[0].ipv6=0
bgpd.@peer[0].next_hop_self=0
bgpd.@peer[0].holdtime_sec=0
bgpd.@peer[0].keepalive_sec=0
bgpd.@peer[0].connect_sec=0
bgpd.@peer[0].routing='bgpd'
bgpd.ROUТЕMAP=routemap
bgpd.ROUТЕMAP.order=10
bgpd.ROUТЕMAP.permit=yes
bgpd.ROUТЕMAP.match_type=ip address
bgpd.ROUТЕMAP.match=192.168.101.1/32
bgpd.ROUТЕMAP.set_type=ip next-hop
bgpd.ROUТЕMAP.set='192.168.101.2/32'
bgpd.ROUТЕMAP.vrf='bgpd'
```

To change any of the above values use **UCI set** command.

Configuring BGP using Package Options

```
root@VA_router:~# uci export bgpd

package bgpd

config routing 'bgpd'

option enabled 'yes'

option router_id '3.3.3.3'

option asn '1'

list network '11.11.11.0/29'

list network '192.168.103.1/32'

config peer

option route_map_in 'yes'

option ipaddr '11.11.11.1'

option asn '1'

option route_map 'ROUTEMAP' option ipv6 '0'

option next_hop_self '0'

option holdtime_sec '0'

option keepalive_sec '0'

option connect_sec '0'

option routing 'bgpd'

config routemap 'ROUTEMAP'

option order '10' option permit 'yes'

option match_type 'ip address'

option match '192.168.101.1/32'

option set_type 'ip next-hop'

option set '192.168.101.2/32'

option routing 'bgpd'
```

18.5. View Routes Statistics

To view routes statistics, in the top menu click **Status -> Routes**. The routing table appears.

Routes

The following rules are currently active on this system.

ARP

IPv4-Address	MAC-Address	Interface
192.168.210.100	50:b7:c3:0c:1e:4b	br-lan
10.1.1.124	d4:ae:52:cd:61:21	eth1
10.1.10.83	00:13:60:51:39:56	eth1

Active IPv4-Routes

Network	Target	IPv4-Gateway	Metric
wan	0.0.0.0/0	10.64.64.64	0
wan	0.0.0.0/0	10.64.64.64	1
LAN2	10.1.0.0/16	0.0.0.0	0
wan	10.64.64.64	0.0.0.0	0
LAN2	192.168.101.1	10.1.10.83	0
lan	192.168.210.0/24	0.0.0.0	0
wan	217.67.129.143	10.64.64.64	0

Active IPv6-Routes

Network	Target	IPv6-Gateway	Metric
loopback	0:0:0:0:0:0:0:0	0:0:0:0:0:0:0:0	FFFFFFFF
loopback	0:0:0:0:0:0:0:0	0:0:0:0:0:0:0:0	FFFFFFFF
loopback	0:0:0:0:0:0:0:1	0:0:0:0:0:0:0:0	00000000
LAN2	FF02:0:0:0:0:0:0:FB	0:0:0:0:0:0:0:0	00000000
(base0)	FF00:0:0:0:0:0:0:8	0:0:0:0:0:0:0:0	00000100
lan	FF00:0:0:0:0:0:0:8	0:0:0:0:0:0:0:0	00000100
LAN2	FF00:0:0:0:0:0:0:8	0:0:0:0:0:0:0:0	00000100
loopback	0:0:0:0:0:0:0:0	0:0:0:0:0:0:0:0	FFFFFFFF

The routing table

To view routes via the command line, enter:

```
root@support:~# route -n
```

Destination	Gateway	Genmask	Flags	Metric	Ref	Use	Iface
10.1.0.0	0.0.0.0	255.255.0.0	U	0	0	0	br-lan2

19. Configuring OSPF

Introduction

OSPF is a standardised link state routing protocol, designed to scale efficiently to support larger networks. Link state protocols track the status and connection type of each link and produce a calculated metric based on these and other factors, including some set by the network administrator. Link state protocols will take a path which has more hops, but that uses a faster medium over a path using a slower medium with fewer hops. OSPF adheres to the following link state characteristics:

- OSPF adheres to the following link state characteristics:
- OSPF employs a hierarchical network design using areas.
- OSPF will form neighbour relationships with adjacent routers in the same area. Instead of advertising the distance to connected networks, OSPF advertises the status of directly connected links using Link-State Advertisements (LSAs)
- OSPF sends updates (LSAs) when there is a change to one of its links, and will only send the change in the update. LSAs are additionally refreshed every 30 minutes.
- OSPF traffic is multicast either to address 224.0.0.5 for all OSPF routers or 224.0.0.6 for all designated routers.
- OSPF uses the Dijkstra shortest path first algorithm to determine the shortest path.
- OSPF is a classless protocol, and therefore supports Variable Length Subnet Masks (VLSMs).

Other characteristics of OSPF include:

- OSPF supports only IP routing.
- OSPF routes have an administrative distance is 110.
- OSPF uses cost as its metric, which is computed based on the bandwidth of the link. OSPF has no hop-count limit.

The OSPF process builds and maintains three separate tables:

- **A neighbour table** containing a list of all neighbouring routers.
- **A topology table** containing a list of all possible routes to all known networks within an area.
- **A routing table** containing the best route for each known network.

19.1. OSPF Areas

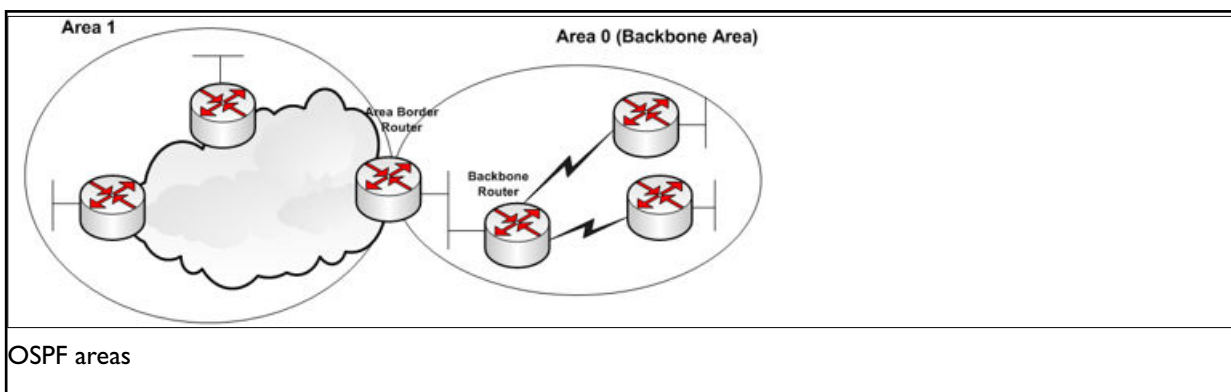

OSPF has a number of features that allow it to scale well for larger networks. One of these features is OSPF areas. OSPF areas break up the topology so that routers in one area know less topology information about the

subnets in the other area, and they do not know anything about the routers in the other area at all. With smaller topology databases, routers consume less memory and take less processing time to run SPF. The Area Border Router (ABR) is the border between two areas. The ABR does not advertise full topology information about the part of the network in area 0 to routers in area 1. Instead the ABR advertises summary information about the subnets in area 0. Area 1 will just see a number of subnets reachable via area 0.

19.2. OSPF Neighbours

OSPF forms neighbour relationships, called adjacencies, with other routers in the same area by exchanging 'hello' packets to multicast address 224.0.0.5. Only after an adjacency is formed can routers share routing information.

Each OSPF router is identified by a unique router ID. The router ID can be determined in one of three ways:

- The router ID can be manually specified.
- If not manually specified, the highest IP address configured on any loopback interface on the router will become the router ID.
- If no loopback interface exists, the highest IP address configured on any physical interface will become the router ID.

By default, hello packets are sent out of OSPF-enabled interfaces every 10 seconds for broadcast and point-to-point interfaces, and 30 seconds for non-broadcast and point-to-multipoint interfaces.

OSPF also has a 'dead interval', which indicates how long a router will wait without hearing any hellos before announcing a neighbour as 'down'. The default setting for the dead interval is 40 seconds for broadcast and point-to-point interfaces; and 120 seconds for non-broadcast and point-to-multipoint interfaces. By default, the dead interval timer is four times the hello interval.

OSPF routers will only become neighbours if the following parameters within a hello packet are identical on each router:

- Area ID
- Area type (stub, NSSA, etc.)
- Prefix
- Subnet mask
- Hello interval
- Dead interval
- Network type (broadcast, point-to-point, etc.)
- Authentication

The hello packets also serve as keepalives to allow routers to quickly discover if a neighbour is down. Hello packets also contain a neighbour field that lists the router IDs of all neighbours the router is connected to. A neighbour table is constructed from the OSPF hello packets, which includes the following information:

- The router ID of each neighbouring router
- The current 'state' of each neighbouring router
- The interface directly connecting to each neighbour
- The IP address of the remote interface of each neighbour

19.3. OSPF Designated Routers

In multi-access networks such as Ethernet, there is the possibility of many neighbour relationships on the same physical segment. This leads to a considerable amount of unnecessary Link State Advertisement (LSA) traffic. If a link of a router were to fail, it would flood this information to all neighbours. Each neighbour, in turn, would then flood that same information to all other neighbours. This is a waste of bandwidth and processor load.

To prevent this, OSPF will elect a Designated Router (DR) for each multi-access network, accessed via multicast address 224.0.0.6. For redundancy purposes, a Backup Designated Router (BDR) is also elected.

OSPF routers will form adjacencies with the DR and BDR. If a change occurs to a link, the update is forwarded only to the DR, which then forwards it to all other routers. This greatly reduces the flooding of LSAs. DR and BDR elections are determined by a router's OSPF priority, which is configured on a per-interface basis as a router can have interfaces in multiple multi-access networks. The router with the highest priority becomes the DR; second highest becomes the BDR. If there is a tie in priority, whichever router has the highest router ID will become the DR.

19.4. OSPF Neighbour States

Neighbour adjacencies will progress through several states, described in the table below.

State	Description						
Down	Indicates that no hellos have been heard from the neighbouring router.						
Init	Indicates a hello packet has been heard from the neighbour, but a two-way communication has not yet been initialised.						
2-Way	Indicates that bidirectional communication has been established. Recalls that hello packets contain a neighbour field; thus, communication is considered 2-way when a router sees its own router ID in its neighbour's hello packet. Designated and backup designated routers are elected at this stage.						
ExStart	Indicates that the routers are preparing to share link state information. Master/slave relationships are formed between routers to determine who will begin the exchange.						
Exchange	Indicates that the routers are exchanging Database Descriptors (DBDs). DBDs contain a description of the router's topology database. A router will examine a neighbour's DBD to determine if it has information to share.						
Loading	Indicates the routers are finally exchanging link state advertisements, containing information about all links connected to each router. Essentially, routers are sharing their topology tables with each other.						
Full	Indicates that the routers are fully synchronised. The topology table of all routers in the area should now be identical. Depending on the role of the neighbour, the state may appear as: <table border="1" data-bbox="304 1084 1398 1238"> <tbody> <tr> <td>Full/DR</td> <td>Indicating that the neighbour is a Designated Router (DR)</td> </tr> <tr> <td>Full/BDR</td> <td>Indicating that the neighbour is a Backup Designated Router (BDR)</td> </tr> <tr> <td>Full/DROther</td> <td>Indicating that the neighbour is neither the DR nor BDR. On a multi-access network, OSPF routers will only form full adjacencies with DRs and BDRs. Non-DRs and non-BDRs will still form adjacencies but will remain in a 2-way state. This is normal OSPF behaviour.</td> </tr> </tbody> </table>	Full/DR	Indicating that the neighbour is a Designated Router (DR)	Full/BDR	Indicating that the neighbour is a Backup Designated Router (BDR)	Full/DROther	Indicating that the neighbour is neither the DR nor BDR. On a multi-access network, OSPF routers will only form full adjacencies with DRs and BDRs. Non-DRs and non-BDRs will still form adjacencies but will remain in a 2-way state. This is normal OSPF behaviour.
Full/DR	Indicating that the neighbour is a Designated Router (DR)						
Full/BDR	Indicating that the neighbour is a Backup Designated Router (BDR)						
Full/DROther	Indicating that the neighbour is neither the DR nor BDR. On a multi-access network, OSPF routers will only form full adjacencies with DRs and BDRs. Non-DRs and non-BDRs will still form adjacencies but will remain in a 2-way state. This is normal OSPF behaviour.						

19.5. OSPF Network Types

OSPF's functionality is different across several different network topology types.

State	Description
Broadcast Multi-Access	<p>Indicates a topology where broadcast occurs. Examples include Ethernet, Token Ring and ATM. OSPF characteristics are:</p> <p>OSPF will elect DRs and BDRs</p> <p>Traffic to DRs and BDRs is multicast to 224.0.0.6.</p> <p>Traffic from DRs and BDRs to other routers is multicast to 224.0.0.5 Neighbours do not need to be manually specified.</p>
Point-to-Point	<p>Indicates a topology where two routers are directly connected. An example would be a point-to-point T1. OSPF characteristics are:</p> <p>OSPF will not elect DRs and BDRs</p> <p>All OSPF traffic is multicast to 224.0.0.5 Neighbours do not need to be manually specified</p>
Point-to-Multipoint	<p>Indicates a topology where one interface can connect to multiple destinations. Each connection between a source and destination is treated as a point-to-point link. For example, point to point-to-multipoint frame relay. OSPF characteristics are:</p> <p>OSPF will not elect DRs and BDRs.</p> <p>All OSPF traffic is multicast to 224.0.0.5. Neighbours do not need to be manually specified.</p>
Non-broadcast Multi-access Network (NBMA)	<p>Indicates a topology where one interface can connect to multiple destinations; however, broadcasts cannot be sent across a NBMA network. For example, Frame Relay. OSPF characteristics are:</p> <p>OSPF will elect DRs and BDRs.</p> <p>OSPF neighbours must be manually defined, so all OSPF traffic is unicast instead of multicast.</p> <p>Note: on non-broadcast networks, neighbours must be manually specified, as multicast hellos are not allowed.</p>

19.6. The OSPF Hierarchy

OSPF is a hierarchical system that separates an autonomous system into individual areas. OSPF traffic can either be:

- intra-area (within one area),
- inter-area (between separate areas), or
- external (from another AS).

OSPF routers build a topology database of all links within their area, and all routers within an area will have an identical topology database. Routing updates between these routers will only contain information about links local to their area. Limiting the topology database to include only the local area conserves bandwidth and reduces CPU loads.

Area 0 is required for OSPF to function, and is considered the backbone area. As a rule, all other areas must have a connection into Area 0, though this rule can be bypassed using virtual links. Area 0 is often referred to as the transit area to connect all other areas.

OSPF routers can belong to multiple areas, and therefore contain separate topology databases for each area. These routers are known as Area Border Routers (ABRs).

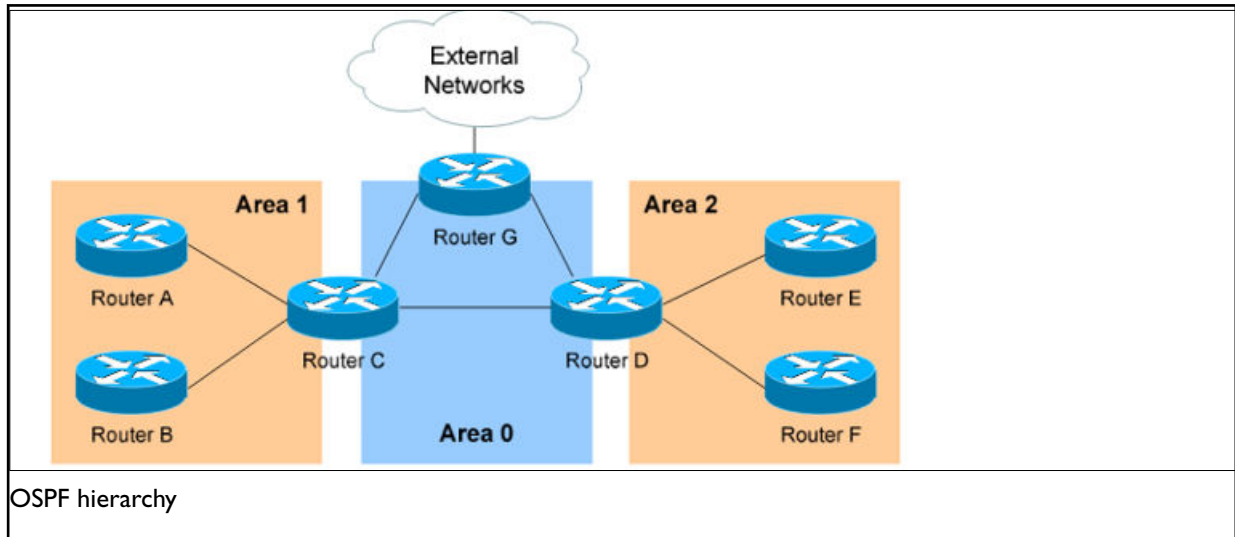

In the above example three areas exist: Area 0, Area 1, and Area 2. Area 0 is the backbone area for this autonomous system.

Both Area 1 and Area 2 must directly connect to Area 0. Routers A and B belong fully to Area 1, while routers E and F belong fully to Area 2. These are known as internal routers.

Router C belongs to both Area 0 and Area 1; so it is an ABR. Because it has an interface in Area 0, it can also be considered a Backbone Router (BR). The same can be said for Router D, as it belongs to both Area 0 and Area 2.

Router G also belongs to Area 0 however it also has a connection to the internet, which is outside this autonomous system. This makes Router G an Autonomous System Border Router (ASBR).

A router can become an ASBR in one of two ways:

- By connecting to a separate Autonomous System, such as the internet
- By redistributing another routing protocol into the OSPF process.

ASBRs provide access to external networks. OSPF defines two types of external routes, as shown in the table below.

Type 2 (E2)	Includes only the external cost to the destination network. External cost is the metric being advertised from outside the OSPF domain. This is the default type assigned to external routes.
Type 1 (E1)	Includes both the external cost, and the internal cost to reach the ASBR, to determine the total metric to reach the destination network. Type 1 routes are always preferred over Type 2 routes to the same destination.

19.7. OSPF Router Types

The four separate OSPF router types are shown in the table below.

Route Type	Description
Internal Router	All router interfaces belong to only one area.
Area Border Router (ABR)	Have interfaces in at least two separate areas.
Backbone Router	Have at least one interface in area 0.
Autonomous System Border Router (ASBR)	Have a connection to a separate autonomous system.

19.8. Configuring OSPF Using The Web Interface

Configuration Package Used

Package	Sections
ospfd	routing
	network
	interface

Select **Network -> OSPF**. The OSPF page appears.

There are three sections in the OSPF page:

Section	Description
Global Settings	Enables OSPF and configures the OSPF routing section containing global configuration parameters. The web automatically names the routing section ospfd.
Topology Configuration	Configures the network sections.
Interfaces Configuration	Configures the interface sections. Defines interface configuration for OSPF and interface specific parameters.

19.8.1. Global Settings

The Global Settings section configures the ospfd routing section. The web automatically names the routing section 'ospfd'.

OSPF

Global Settings

OSPF Enabled

Router ID ? IP address format, must be unique, if blank it generates Router ID automatically

Make Default Router

The OSPF global settings configuration page

Web Field/UCI/Package Option	Description				
Web: OSPF Enabled UCI: ospfd.ospfd.enabled Opt: enabled	Enables OSPF advertisements on router. <table border="1"> <tr> <td>Default: 0</td> <td>Disabled</td> </tr> <tr> <td>1</td> <td>Enabled</td> </tr> </table>	Default: 0	Disabled	1	Enabled
Default: 0	Disabled				
1	Enabled				
Web: Router ID UCI: ospfd.ospfd.router_id Opt: router_id	This sets the router ID of the OSPF process. The router ID may be an IP address of the router, but need not be - it can be any arbitrary 32bit number. However it MUST be unique within the entire OSPF domain to the OSPF speaker. If one is not specified, then ospfd will obtain a router-ID automatically from the zebra daemon. <table border="1"> <tr> <td>Default</td> <td>Empty</td> </tr> <tr> <td>Range</td> <td></td> </tr> </table>	Default	Empty	Range	
Default	Empty				
Range					
Web: Make Default Router UCI: ospfd.ospfd.default_info_originate Opt: default_info_originate	Defines whether to originate an AS-External (type-5) LSA describing a default route into all external-routing capable areas, of the specified metric and metric type. <table border="1"> <tr> <td>Default: 0</td> <td>Disabled</td> </tr> <tr> <td>1</td> <td>Enabled</td> </tr> </table>	Default: 0	Disabled	1	Enabled
Default: 0	Disabled				
1	Enabled				
Web: n/a UCI: ospfd.ospfd.vty_enabled Opt: vty_enabled	Enable vty for OSPFd (telnet to localhost:2604)				
Web: n/a UCI: ospfd.ospfd.vrf Opt: vrf	Defines the VRF for OSPF <table border="1"> <tr> <td>Default</td> <td>No VRF</td> </tr> <tr> <td>Range</td> <td></td> </tr> </table>	Default	No VRF	Range	
Default	No VRF				
Range					

19.8.2. Topology Configuration

The Topology Configuration section configures the ospfd network section. This section specifies the OSPF enabled interface(s). The router can provide network information to the other OSPF routers via this interface.



NOTE

To advertise OSPF on an interface, the network mask prefix length for the topology configuration statement for the desired interface advertisement must be equal or smaller, that is, a larger network, than the network mask prefix length for the interface.

For example, the topology configuration statement in the screenshot below does not enable OSPF on an interface with address 12.1.1.1/23, but it would enable OSPF on an interface with address 12.1.1.129/25.

Topology Configuration

Network	Mask Length	Area	Stub Area
<i>Only for non-backbone areas</i>			
<input type="text" value="12.1.1.1"/>	<input type="text" value="24"/>	<input type="text" value="0"/>	<input checked="" type="checkbox"/>
<input type="button" value="Add"/>			

The OSPF topology configuration page

Web Field/UCI/Package Option	Description				
Web: Network UCI: ospfd.@network[0].ip_addr Opt: ip_addr	Specifies the IP address for OSPF enabled interface. Format: A.B.C.D				
Web: Mask Length UCI: ospfd.@network[0].mask_length Opt: mask_length	Specifies the mask length for OSPF enabled interface. The mask length should be entered in CIDR notation.				
Web: Area UCI: ospfd.@network[0].area Opt: area	Specifies the area number for OSPF enabled interface.				
Web: Stub Area UCI: ospfd.@network[0].stub_area Opt: stub_area	<p>Only for non-backbone areas.</p> <p>Configures the area to be a stub area. That is, an area where no router originates routes external to OSPF and hence an area where all external routes are via the ABR(s).</p> <p>ABRs for such an area do not need to pass AS-External LSAs (type-5s) or ASBR-Summary LSAs (type-4) into the area. They need only pass network-summary (type-3) LSAs into such an area, along with a default-route summary.</p> <table border="1"> <tr> <td>Default: 0</td> <td>Disabled</td> </tr> <tr> <td>1</td> <td>Enabled</td> </tr> </table>	Default: 0	Disabled	1	Enabled
Default: 0	Disabled				
1	Enabled				

19.8.3. Interfaces Configuration

The Interfaces Configuration section contains settings to configure the OSPF interface. It defines interface configurations for OSPF and interface specific parameters.

OSPFv2 allows packets to be authenticated using either an insecure plain text password, included with the packet, or by a more secure MD5 based HMAC (keyed-Hashing for Message Authentication). Enabling authentication prevents routes being updated by unauthenticated remote routers, but still can allow routes, that is, the entire OSPF routing table, to be queried remotely, potentially by anyone on the internet, via OSPFv1.

This section defines key_chains to be used for MD5 authentication.

Interfaces Configuration

Interface LAN: (no interfaces attached)

LAN1: 

MOBILE1: 

PPPoADSL: 

loopback: 

Network Type Leave as default if unknown. Default depends on the type of interface

Passive

Hello Interval Defaults: broadcast/point-to-point 10 secs, non-broadcast/point-to-multipoint 30 secs

Dead Interval Defaults: broadcast/point-to-point 40 secs, non-broadcast/point-to-multipoint 120 secs

Routing priority OSPF route priority, zero for never

Authentication

Text Auth. Key

The OSPF interfaces configuration section

Web Field/UCI/Package Option	Description										
Web: Interface UCI: ospfd.@interface[0].ospf_interface Opt: ospf_interface	Defines the interface name.										
Web: Network Type UCI: ospfd.@interface[0].network_type Opt: network_type	Defines the network type for specified interface. <table border="1" data-bbox="639 409 1398 611"> <tr> <td>Default</td> <td>Autodetect: it will broadcast. If broadcast is not supported on that interface then use point-to-point.</td> </tr> <tr> <td>broadcast</td> <td></td> </tr> <tr> <td>non-broadcast</td> <td></td> </tr> <tr> <td>point-to-point</td> <td></td> </tr> <tr> <td>point-to-multipoint</td> <td></td> </tr> </table>	Default	Autodetect: it will broadcast. If broadcast is not supported on that interface then use point-to-point.	broadcast		non-broadcast		point-to-point		point-to-multipoint	
Default	Autodetect: it will broadcast. If broadcast is not supported on that interface then use point-to-point.										
broadcast											
non-broadcast											
point-to-point											
point-to-multipoint											
Web: Passive UCI: ospfd.@interface[0].passive Opt: passive	Does not send hello packets on the given interface, but does advertise the interface as a stub link in the router-LSA (Link State Advertisement) for this router. This allows you to advertise addresses on such connected interfaces without having to originate AS-External/Type-5 LSAs, which have global flooding scope, as would occur if connected addresses were redistributed into OSPF. This is the only way to advertise non-OSPF links into stub areas. <table border="1" data-bbox="639 840 826 909"> <tr> <td>Default: 0</td> <td>Disabled</td> </tr> <tr> <td>1</td> <td>Enabled</td> </tr> </table>	Default: 0	Disabled	1	Enabled						
Default: 0	Disabled										
1	Enabled										
Web: Hello Interval UCI: ospfd.@interface[0].hello_interval Opt: hello_interval	Defines the number of seconds for the Hello Interval timer value. A hello packet will be sent every x seconds, where x is the configured hello interval value on the specified interface. This value must be the same for all routers attached to a common network. The default is every 10 seconds for broadcast and point-to-point interfaces, and 30 seconds for non-broadcast and point-to- multipoint interfaces. <table border="1" data-bbox="639 1162 826 1232"> <tr> <td>Default</td> <td>10 seconds</td> </tr> <tr> <td>Range</td> <td></td> </tr> </table>	Default	10 seconds	Range							
Default	10 seconds										
Range											
Web: Dead interval UCI: ospfd.@interface[0].dead_interval Opt: dead_interval	Defines the number of seconds for the dead interval timer value used for wait timer and inactivity timer. This value must be the same for all routers attached to a common network. The default is 40 seconds for broadcast and point-to-point interfaces, and 120 seconds for non-broadcast and point-to- multipoint interfaces. By default, the dead interval timer is four times the hello interval. <table border="1" data-bbox="639 1462 826 1532"> <tr> <td>Default</td> <td>40 seconds</td> </tr> <tr> <td>Range</td> <td></td> </tr> </table>	Default	40 seconds	Range							
Default	40 seconds										
Range											
Web: Routing priority UCI: ospfd.@interface[0].priority Opt: priority	Defines priority to become the designated router. A value of 0 means never become a designated router; other values in the range 1-255 are allowed, with 255 being most likely to be a designated router, and 1 being least likely. <table border="1" data-bbox="639 1706 788 1776"> <tr> <td>Default</td> <td>1</td> </tr> <tr> <td>Range</td> <td>0-255</td> </tr> </table>	Default	1	Range	0-255						
Default	1										
Range	0-255										
Web: Authentication UCI: ospfd.@interface[0].auth_mode Opt: auth_mode	OSPFv2 (only) allows packets to be authenticated via either an insecure plain text password, included with the packet, or via a more secure MD5 based HMAC (keyed-Hashing for Message AuthentIcation). Enabling authentication prevents routes being updated by unauthenticated remote routers, but still can allow routes, that is, the entire OSPF routing table to be queried remotely, potentially by anyone on the internet, via OSPFv1. <table border="1" data-bbox="639 1986 1238 2018"> <tr> <td>Default: no</td> <td>No authentication</td> </tr> </table>	Default: no	No authentication								
Default: no	No authentication										

Web Field/UCI/Package Option	Description	
	md5	Sets the interface with OSPF MD5 authentication.
	text	Sets the interface with OSPF simple password authentication.
Web: Text Auth. Key UCI: ospfd.@interface[0].text_auth_key Opt: text_auth_key	This command sets authentication string for text authentication. text_auth_key option can have length up to 8 characters. Displayed only when authentication is set to text .	
Web: Key ID UCI: ospfd.@interface[0].key_id Opt: key_id	Specifies key ID. Must be unique and match at both ends. Displayed only when authentication is set to MD5 .	
Web: MD5 Auth. Key UCI: ospfd.@interface[0].md5_auth_key Opt: md5_auth_key	Specifies keyed MD5 chain. Displayed only when authentication is set to MD5 .	

19.9. Configuring OSPF Using The Command Line

OSPF is configured under the ospfd package /etc/config/ospfd. There are three config sections: ospfd, interface and network. You can configure multiple interface and network sections.

By default, all OSPF interface instances are named interface, instances are identified by @interface then the interface position in the package as a number. For example, for the first interface in the package using UCI:

```
ospfd.@interface[0]=interface
ospfd.@interface[0].ospf_interface=lan
```

Or using package options:

```
config interface
option ospf_interface 'lan'
```

By default, all OSPF network instances are named network, it is identified by @network then the interface position in the package as a number. For example, for the first network in the package using UCI:

```
ospfd.@network[0]=network
ospfd.@network[0].ip_addr=12.1.1.1
```

Or using package options:

```
config network
option ip_addr '12.1.1.1'
```

19.10. Configuring OSPF Using UCI

```
root@VA_router:~# uci show ospfd
ospfd.ospfd=routing
ospfd.ospfd.enabled=yes
ospfd.ospfd.default_info_originate=yes
ospfd.ospfd.router_id=1.2.3.4
ospfd.ospfd.vrf=datavrf
ospfd.@network[0]=network
ospfd.@network[0].ip_addr=12.1.1.1
ospfd.@network[0].mask_length=24
ospfd.@network[0].area=0
ospfd.@network[0].stub_area=yes
ospfd.@interface[0]=interface
ospfd.@interface[0].ospf_interface=lan8
ospfd.@interface[0].hello_interval=10
ospfd.@interface[0].dead_interval=40
ospfd.@interface[0].priority=1
ospfd.@interface[0].network_type=broadcast
ospfd.@interface[0].passive=yes
ospfd.@interface[0].auth_mode=text
ospfd.@interface[0].text_auth_key=secret
ospfd.@interface[1]=interface
ospfd.@interface[1].ospf_interface=lan7
ospfd.@interface[1].network_type=point-to-point
ospfd.@interface[1].passive=no
ospfd.@interface[1].hello_interval=30
ospfd.@interface[1].dead_interval=120
ospfd.@interface[0].priority=2
ospfd.@interface[1].auth_mode=md5
ospfd.@interface[1].key_id=1
ospfd.@interface[1].md5_auth_key=test
```

OSPF using package options

```
root@VA_router:~# uci export ospfd
package ospfd
config routing 'ospfd'
option enabled 'yes'
option default_info_originate 'yes'
option router_id '1.2.3.4'
option vrf 'datavrf'
config network
option ip_addr '12.1.1.1'
option mask_length '24'
option area '0'
option stub_area 'yes'
config interface
option ospf_interface 'lan8'
option hello_interval '10'
option dead_interval '40'
option priority '1'
option network_type 'broadcast'
option passive 'yes'
option auth_mode 'text'
option text_auth_key 'secret'
config interface
option ospf_interface 'lan7'
option network_type 'point-to-point'
option passive 'no'
option hello_interval '30'
option dead_interval '120'
option priority '2'
option auth_mode 'md5'
option key_id '1'
option md5_auth_key 'test'
```

19.11. OSPF Diagnostics

Route Status

To show the current routing status, enter:

```
root@VA_router:~# route -n
```

Kernel IP routing table							
Destination	Gateway	Genmask	Flags	Metric	Ref	Use	Iface
0.0.0.0	10.206.4.65	0.0.0.0	UG	1	0	0	usb0
10.1.0.0	0.0.0.0	255.255.0.0	U	0	0	0	eth1
10.206.4.64	0.0.0.0	255.255.255.252	U	0	0	0	usb0
11.11.11.0	0.0.0.0	255.255.255.248	U	0	0	0	gre-GRE
89.101.154.151	10.206.4.65	255.255.255.255	UGH	0	0	0	usb0
192.168.100.0	0.0.0.0	255.255.255	U	0	0	0	eth0
192.168.101	11.11.11.1	255.255.255.255	UGH	11	0	0	gre-GRE
192.168.104.1	11.11.11.4	255.255.255.255	UGH	20	0	0	gre-GRE



NOTE

A route will only be displayed in the routing table when the interface is up.

Tracing OSPF Packets

Typically, OSPF uses IP as its transport protocol. The well-known IP protocol type for OSPF traffic is 0x59. To trace OSPF packets on any interface on the router, enter:

```
tcpdump -i any -n proto ospf &
```

```
root@VA_router:~# tcpdump -i any -n proto ospf & root@VA_router:~# tcpdump: verbose output suppressed, use -v or -vv for full protocol decode
listening on any, link-type LINUX_SLL (Linux cooked), capture size 65535 bytes
```

To stop tracing, enter **fg** to bring tracing task to foreground, and then **<ctrl-C>** to stop the trace.

```
root@VA_router:~# fg
tcpdump -i any -n proto ospf
^C 33 packets captured
33 packets received by filter
0 packets dropped by kernel
```

19.11.1. Quagga/Zebra Console OSPF

Quagga is the routing protocol suite embedded in the router firmware. Quagga is split into different daemons for implementation of each routing protocol. Zebra is a core daemon for Quagga, providing the communication layer to the underlying Linux kernel, and routing updates to the client daemons.

Quagga has a console interface to Zebra for advanced debugging of the routing protocols.

To access, enter:

```
root@VA_router:~# telnet localhost zebra
Entering character mode Escape character is '^]'.
Hello, this is Quagga (version 0.99.21).
Copyright 1996-2005 Kunihiro Ishiguro, et al.
User Access Verification
Password:
```

To see OSPF routing from Zebra console, enter:

```
root@VA_router:~# sh ip route
Codes: K - kernel route, C - connected, S - static, R - RIP,
O - OSPF, I - IS-IS, B - BGP, P - PIM, H - HSLs, o - OLSR,
b - BATMAN, A - Babel,
> - selected route, * - FIB route
K>* 0.0.0.0/0 via 10.206.4.65, usb0
O 10.1.0.0/16 [110/11] via 11.11.11.1, gre-GRE, 02:35:28
C>* 10.1.0.0/16 is directly connected, eth1
C>* 10.206.4.64/30 is directly connected, usb0
O 11.11.11.0/29 [110/10] is directly connected, gre-GRE, 02:35:29
C>* 11.11.11.0/29 is directly connected, gre-GRE
K>* 89.101.154.151/32 via 10.206.4.65, usb0
C>* 127.0.0.0/8 is directly connected, lo
C>* 192.168.100.0/24 is directly connected, eth0
O>* 192.168.101.1/32 [110/11] via 11.11.11.1, gre-GRE, 02:35:28
O>* 192.168.104.1/32 [110/20] via 11.11.11.4, gre-GRE, 02:30:45
O 192.168.105.1/32 [110/10] is directly connected, lo, 02:47:52
C>* 192.168.105.1/32 is directly connected, lo
```

19.11.2. OSPF Debug Console

When option `vtty_enabled` is enabled in the OSPF configuration, the OSPF debug console can be accessed for advanced OSPF debugging. For more information, read the Global Settings section above.

To access OSPF debug console enter: `telnet localhost ospfd (password zebra)`

```

root@VA_router:~# telnet localhost ospfd

Entering character mode

Escape character is '^'.

Hello, this is Quagga (version 0.99.21).

Copyright 1996-2005 Kunihiro Ishiguro, et al.

User Access Verification

Password:

```

To see OSPF routing from OSPF debug console, enter:

```

UUT> sh ip ospf route

===== OSPF network routing table =====

N 10.1.0.0/16 [11] area: 0.0.0.0

via 11.11.11.1, gre-GRE

N 11.11.11.0/29 [10] area: 0.0.0.0

directly attached to gre-GRE

N 192.168.101.1/32 [11] area: 0.0.0.0

via 11.11.11.1, gre-GRE

N 192.168.104.1/32 [20] area: 0.0.0.0

via 11.11.11.4, gre-GRE

N 192.168.105.1/32 [10] area: 0.0.0.0

directly attached to lo

===== OSPF router routing table =====

===== OSPF external routing table =====

```

To see OSPF neighbours from OSPF debug console, enter:

```

root@VA_router:~# sh ip ospf neighbor

```

Neighbor ID	Pri State	Dead Time Address	Interface	RXmtL	RqstL	DBsmL
1.1.1.1	255 Full/DR	33.961s 11.11.11.1	gre-GRE:11.11.11.5	0	0	0

To see OSPF interface details from OSPF debug console, enter:

```
root@VA_router:~# sh ip ospf interface
base0 is up
ifindex 8, MTU 1518 bytes, BW 0 Kbit <UP,BROADCAST,RUNNING,MULTICAST>
OSPF not enabled on this interface
eth0 is up
ifindex 9, MTU 1500 bytes, BW 0 Kbit <UP,BROADCAST,RUNNING,MULTICAST>
OSPF not enabled on this interface
eth1 is up
```



```
ifindex 10, MTU 1500 bytes, BW 0 Kbit
<UP,BROADCAST,RUNNING,PROMISC,MULTICAST>
OSPF not enabled on this interface
eth2 is down
ifindex 11, MTU 1500 bytes, BW 0 Kbit <BROADCAST,MULTICAST>
OSPF not enabled on this interface
eth3 is down
ifindex 12, MTU 1500 bytes, BW 0 Kbit <BROADCAST,MULTICAST>
OSPF not enabled on this interface
eth4 is down
ifindex 13, MTU 1500 bytes, BW 0 Kbit <BROADCAST,MULTICAST>
OSPF not enabled on this interface
eth5 is down
ifindex 14, MTU 1500 bytes, BW 0 Kbit <BROADCAST,MULTICAST>
OSPF not enabled on this interface
eth6 is down
ifindex 15, MTU 1500 bytes, BW 0 Kbit <BROADCAST,MULTICAST>
OSPF not enabled on this interface
eth7 is down
ifindex 16, MTU 1500 bytes, BW 0 Kbit <BROADCAST,MULTICAST>
OSPF not enabled on this interface
gre-GRE is up
ifindex 19, MTU 1472 bytes, BW 0 Kbit <UP,RUNNING,MULTICAST>
Internet Address 11.11.11.5/29, Area 0.0.0.0 MTU mismatch detection:enabled
Router ID 192.168.105.1, Network Type BROADCAST, Cost: 10
Transmit Delay is 1 sec, State Backup, Priority 1
Designated Router (ID) 1.1.1.1, Interface Address 11.11.11.1
Backup Designated Router (ID) 192.168.105.1, Interface Address 11.11.11.5
Multicast group memberships: OSPFAllRouters OSPFDesignatedRouters
Timer intervals configured, Hello 10s, Dead 40s, Wait 40s, Retransmit 5
Hello due in 3.334s
Neighbor Count is 1, Adjacent neighbor count is 1
gre0 is down
ifindex 6, MTU 1476 bytes, BW 0 Kbit <NOARP>
OSPF not enabled on this interface
ifb0 is down
```

```

ifindex 2, MTU 1500 bytes, BW 0 Kbit <BROADCAST,NOARP>

OSPF not enabled on this interface

ifb1 is down

ifindex 3, MTU 1500 bytes, BW 0 Kbit <BROADCAST,NOARP>

OSPF not enabled on this interface

lo is up

ifindex 1, MTU 16436 bytes, BW 0 Kbit <UP,LOOPBACK,RUNNING>

Internet Address 192.168.105.1/32, Broadcast 192.168.105.1, Area 0.0.0.0 MTU mismatch detection:enabled

Router ID 192.168.105.1, Network Type LOOPBACK, Cost: 10 Transmit Delay is 1 sec, State Loopback, Priority 1

No designated router on this network

No backup designated router on this network Multicast group memberships: <None>

Timer intervals configured, Hello 10s, Dead 40s, Wait 40s, Retransmit 5 Hello due in inactive

Neighbor Count is 0, Adjacent neighbor count is 0

sit0 is down

ifindex 7, MTU 1480 bytes, BW 0 Kbit <NOARP>

OSPF not enabled on this interface

teq|0 is down

ifindex 4, MTU 1500 bytes, BW 0 Kbit <NOARP>

OSPF not enabled on this interface

tunl0 is down

ifindex 5, MTU 1480 bytes, BW 0 Kbit <NOARP>

OSPF not enabled on this interface

usb0 is up

ifindex 17, MTU 1500 bytes, BW 0 Kbit <UP,BROADCAST,RUNNING,MULTICAST>

OSPF not enabled on this interface

```

To see OSPF database details from OSPF debug console, enter:

```

root@VA_router:~# sh ip ospf database

OSPF Router with ID (192.168.105.1)

Router Link States (Area 0.0.0.0)

```

```

Link ID ADV Router Age Seq# CkSum Link count 1.1.1.1 1.1.1.1 873 0x80006236 0xd591 3
192.168.104.1 192.168.104.1 596 0x8000000a 0x3a2d 2
192.168.105.1 192.168.105.1 879 0x8000000b 0x4919 2

Net Link States (Area 0.0.0.0)

Link ID ADV Router Age Seq# CkSum 11.11.11.1 1.1.1.1 595 0x80000004 0x5712

```

20. Configuring VRRP

Virtual Router Redundancy Protocol (VRRP) is a networking protocol designed to eliminate the single point of failure inherent in the static default routed environment.

VRRP specifies an election protocol that dynamically assigns responsibility for a virtual router to one of the VRRP routers on a LAN. The VRRP router controlling the IP address(es) associated with a virtual router is called the Master, and forwards packets sent to these IP addresses. The election process provides dynamic failover in the forwarding responsibility from the Master to a backup router should the Master become unavailable. This process allows the virtual router IP address(es) on the LAN to be used as the default first hop router by end hosts. The advantage gained from using VRRP is a higher availability default path without requiring configuration of dynamic routing or router discovery protocols on every end host.

Two or more routers forming the redundancy cluster are configured with the same router ID and virtual IP address. A VRRP router group operates within the scope of the single LAN. Additionally, the VRRP routers are configured with its initial role (Master or Backup) and the router priority, which is a factor in the master router election process. You can also configure a password authentication to protect VRRP protocol messages against spoofing.

The VRRP protocol is implemented according to internet standard RFC2338.

Configuration package used

Package	Sections
vrrp	main
	vrrp_group

20.1. Configuring Static Routes Using The Web Interface

In the top menu, select Network -> Static Routes. The Routes page appears.

The routes page

In the IPv4 Routes section , click **Add**.

Web Field/UCI/Package Option	Description				
Web: Interface UCI: network.@route[0].interface Opt: interface	Specifies the logical interface name of the parent or master interface this route belongs to. It must refer to one of the defined interface sections.				
Web: target UCI: network.@router[0].target Opt: target	Specifies the route network IP address.				
Web: netmask UCI: network.@route[0].netmask Opt: netmask	Defines the route netmask. If omitted, 255.255.255.255 is assumed, which makes the target a host address.				
Web: Gateway UCI: network.@route[0].gateway Opt: Gateway	Network gateway. If omitted, the gateway from the parent interface is taken. If set to 0.0.0.0 no gateway will be specified for the route.				
Web: Metric UCI: network.@route[0].metric Opt: metric	Specifies the route metric to use. <table border="1" data-bbox="555 922 670 996"> <tr> <td>Default</td> <td>0</td> </tr> <tr> <td>Range</td> <td></td> </tr> </table>	Default	0	Range	
Default	0				
Range					
Web: MTU UCI: network.@route[0].mtu Opt:mtu	Defines a specific MTU for this route. If omitted, the MTU from the parent interface will be taken. <table border="1" data-bbox="555 1093 699 1162"> <tr> <td>Default</td> <td>Blank</td> </tr> <tr> <td>Range</td> <td></td> </tr> </table>	Default	Blank	Range	
Default	Blank				
Range					

20.2. Configuring VRRP Using The Web Interface

To configure VRRP through the web interface, in the top menu, select **Network -> VRRP**. The VRRP page appears.

Section	Description
Global Settings	Enables VRRP
VRRP Group Configuration	Configures the VRRP group settings

20.3. VRRP Global Settings

The Global Settings section configures the vrrp package main section. To access configuration settings, click **ADD**.

VRRP

Global Settings

VRRP Enabled

The VRRP global settings configuration page

Web Field/UCI/Package Option	Description				
Web: VRRP Enabled	Globally enables VRRP on the router.				
UCI: vrrp.main.enabled	<table border="1"> <tr> <td>Default: 0</td> <td>Disabled</td> </tr> <tr> <td>1</td> <td>Enabled</td> </tr> </table>	Default: 0	Disabled	1	Enabled
Default: 0	Disabled				
1	Enabled				
Opt: Enabled					

20.4. VRRP Group Configuration Settings

The VRRP Group Configuration section configures vrrp package vrrp_group section. To access configuration settings, enter a VRRP group name and click **ADD**.

VRRP Group Configuration

Use the 'Add' textbox to enter a new VRRP group name and create a VRRP group

This section contains no values yet

The VRRP group name configuration page

VRRP Group Configuration

Group enabled

Interface LAN1: (no interfaces attached)

LAN2: 

LAN3: 

MOBILE1: 

PoAASDL: 

loopback: 

Interface to serve

Current State

Track interfaces LAN1: (no interfaces attached)

LAN2: 

LAN3: 

MOBILE1: 

PoAASDL: 

loopback: 

Interfaces to monitor

Track IPsec Tunnel IPsecTunnel1

IPsecTunnel2

IPsec connection(s) to monitor

Track IPsec Fail Time  Consider IPsec tunnel failed if tunnel is down for that many seconds

IPsec Connection  IPsec connection to bring down/up when VRRP enters BACKUP/MASTER state

Start role

Router ID

Priority

The VRRP group configuration page

Web Field/UCI/Package Option	Description				
Web: Group Enabled UCI: vrrp.@vrrp_group[X].enabled Opt: Enabled	Enables a VRRP group on the router. <table border="1"> <tr> <td>Default: 0</td> <td>Disabled</td> </tr> <tr> <td>1</td> <td>Enabled</td> </tr> </table>	Default: 0	Disabled	1	Enabled
Default: 0	Disabled				
1	Enabled				
Web: Interface UCI: vrrp.@vrrp_group[X].interface Opt: interface	Sets the local LAN interface name in which the VRRP cluster is to operate. For example, 'lan'. The interface name is taken from the network package and all configured interfaces will be displayed. <table border="1"> <tr> <td>Default</td> <td>lan</td> </tr> <tr> <td>Range</td> <td></td> </tr> </table>	Default	lan	Range	
Default	lan				
Range					
Web: Track Interfaces UCI: vrrp.@vrrp_group[X].track_iface Opt: list track_iface	Defines one or more WAN interfaces that VRRP should monitor. If a monitored interface goes down on the master VRRP router, it goes into 'Fault' state and the backup VRRP router becomes the master. Multiple interfaces are entered using uci set and uci add_list commands. Example: <pre>uci set vrrp.@vrrp_group[0].track_iface=wan1 uci add_list vrrp.@vrrp_group[0].track_iface=wan2</pre> or using a list of options via package options <pre>list track_iface 'wan1' list track_iface 'wan2'</pre> <table border="1"> <tr> <td>Default</td> <td>Wan</td> </tr> <tr> <td>Range</td> <td></td> </tr> </table>	Default	Wan	Range	
Default	Wan				
Range					
Web: Track IPsec Tunnel UCI: vrrp.@vrrp_group[X].track_ipsec Opt: list track_ipsec	Defines one or more IPsec tunnels that VRRP should monitor. If a monitored tunnel goes down on the master VRRP router for the configured Track IPsec Fail Time, it goes into 'Fault' state and the backup VRRP router becomes the master. Multiple IPsec connections are entered using uci set and uci add_list commands. Example: <pre>uci set vrrp.@vrrp_group[0].track_ipsec=Tunnel1 uci add_list vrrp.@vrrp_group[0].track_ipsec=Tunnel2</pre> or using a list of options via package options <pre>list track_ipsec 'Tunnel1' list track_ipsec 'Tunnel2'</pre> <table border="1"> <tr> <td>Default: Blank</td> <td>No IPsec connection to track</td> </tr> <tr> <td>Range</td> <td></td> </tr> </table>	Default: Blank	No IPsec connection to track	Range	
Default: Blank	No IPsec connection to track				
Range					
Web: Track IPsec Fail Time UCI: vrrp.@vrrp_group[X]. track_ipsec_fail_sec Opt: track_ipsec_fail_sec	Defines duration in seconds to determine IPsec tunnel failure. <table border="1"> <tr> <td>Default</td> <td>300 seconds</td> </tr> <tr> <td>Range</td> <td></td> </tr> </table>	Default	300 seconds	Range	
Default	300 seconds				
Range					
Web: IPsec connection UCI: vrrp.@vrrp_group[X].ipsec_connection Opt: ipsec_connection	Sets which IPsec connection to bring up or down when VRRP enters 'backup/master' state. Multiple IPsec connections are entered via the package option using a space separator. Example: <pre>option ipsec_connection 'IPsecTunnel1 IPsecTunnel2'</pre> <table border="1"> <tr> <td>Default</td> <td>Blank. No IPsec connection to toggle</td> </tr> <tr> <td>Range</td> <td></td> </tr> </table>	Default	Blank. No IPsec connection to toggle	Range	
Default	Blank. No IPsec connection to toggle				
Range					
Web: Start role	Sets the initial role in which a VRRP router starts up. In a cluster of VRRP routes, set one as a master and the others as backup.				

Web Field/UCI/Package Option	Description				
UCI: vrrp.@vrrp_group[X].init_state Opt: init_state	<table border="1"> <tr> <td>Default</td> <td>BACKUP</td> </tr> <tr> <td></td> <td>MASTER</td> </tr> </table>	Default	BACKUP		MASTER
Default	BACKUP				
	MASTER				
Web: Router ID UCI: vrrp.@vrrp_group[X].router_id Opt: router_id	Sets the VRRP router ID (1 to 255). All co-operating VRRP routers serving the same LAN must be configured with the same router ID. <table border="1"> <tr> <td>Default</td> <td>1</td> </tr> <tr> <td>Range</td> <td>1-255</td> </tr> </table>	Default	1	Range	1-255
Default	1				
Range	1-255				
Web: Priority UCI: vrrp.@vrrp_group[X].priority Opt: priority	Sets the VRRP router's priority. Higher values equal higher priority. The VRRP routers must use priority values between 1-254. The master router uses a higher priority. <table border="1"> <tr> <td>Default</td> <td>100</td> </tr> <tr> <td>Range</td> <td>0-255</td> </tr> </table>	Default	100	Range	0-255
Default	100				
Range	0-255				
Web: Advert intvl UCI: vrrp.@vrrp_group[X].advert_int_sec Opt: advert_int_sec	Sets the VRRP hello value in seconds. This value must match the value set on a peer. <table border="1"> <tr> <td>Default</td> <td>120 seconds</td> </tr> <tr> <td>Range</td> <td>Enable</td> </tr> </table>	Default	120 seconds	Range	Enable
Default	120 seconds				
Range	Enable				
Web: Password UCI: vrrp.@vrrp_group[X].password Opt: password	Sets the password to use in the VRRP authentication (simple password authentication method). This field may be left blank if no authentication is required.				
Web: Virtual IP UCI: vrrp.@vrrp_group[X].virtual_ipaddr Opt: virtual_ipaddr	Sets the virtual IP address and mask in prefix format. For example, '11.1.1.99/24'. All co-operating VRRP routers serving the same LAN must be configured with the same virtual IP address.				
Web: GARP delay UCI: vrrp.@vrrp_group[X].garp_delay_sec Opt: garp_delay_sec	Sets the gratuitous ARP message sending delay in seconds.				

20.5. Configuring VRRP Using Command Line

The configuration file is stored on `/etc/config/vrrp`. There are two config sections: `main` and `vrrp_group`.

You can configure multiple VRRP groups. By default, all VRRP group instances are named 'vrrp_group'. Instances are identified by `@vrrp_group` then the `vrrp_group` position in the package as a number. For example, for the first `vrrp_group` in the package using UCI:

```
vrrp.@vrrp_group[0]=vrrp_group
vrrp.@vrrp_group[0].enabled=1
```

Or using package options:

```
config vrrp_group
option enabled '1'
```

However, to better identify, it is recommended to give the `vrrp_group` instance a name. For example, to define a `vrrp_group` instance named 'g1' using UCI, enter:

```
vrrp.g1.vrrp_group
vrrp.g1.enabled=1
```

To define a named keepalive instance using package options, enter:

```
config vrrp_group 'g1'
option enabled '1'
```

20.5.1. VRRP Using UCI

To view the configuration in UCI format, enter:

```
root@VA_router:~# uci show vrrp
vrrp.main=vrrp
vrrp.main.enabled=yes
vrrp.g1=vrrp_group
vrrp.g1.enabled=yes
vrrp.g1.interface=lan
vrrp.g1.track_iface=WAN MOBILE
vrrp.g1.init_state=BACKUP
vrrp.g1.router_id=1
vrrp.g1.priority=100
vrrp.g1.advert_int_sec=120
vrrp.g1.password=secret
vrrp.g1.virtual_ipaddr=10.1.10.150/16
vrrp.g1.garp_delay_sec=5
vrrp.g1.ipsec_connection=Test
vrrp.g1.track_ipsec=conn1 conn2
```

VRRP using package options

To view the configuration in package option format, enter:

```
root@VA_router:~# uci export vrrp
package vrrp
config vrrp 'main'
option enabled 'yes'

config vrrp_group 'g1'
option enabled 'yes'
option interface 'lan'
list track_iface 'WAN'
list track_iface 'MOBILE'
option init_state 'BACKUP'
option router_id '1'
option priority '100'
option advert_int_sec '120'
option password 'secret'
option virtual_ipaddr '10.1.10.150/16'
option garp_delay_sec '5'
option ipsec_connection 'Test'
list track_ipsec 'conn1'
list track_ipsec 'conn2'
```

20.6. VRRP Diagnostics

VRRP Process using UCI

The VRRP process has its own subset of commands.

```
root@VA_router:~# /etc/init.d/vrrp
Syntax: /etc/init.d/vrrp [command]
```

Available commands:

```
start Start the service stop Stop the service restart Restart the service
reload Reload configuration files (or restart if that fails) enable Enable service autostart
disable Disable service autostart
```

To restart VRRP, enter:

```
root@VA_router:~# /etc/init.d/vrrp restart
```

21. Configuring RIP

RIP is a dynamic routing algorithm used on IP-based internet networks.

A distance vector routing algorithm is used by RIP to assist in maintaining network convergence. It uses a metric or 'hop' count as the only routing criteria. Each route is advertised with the number of hops a datagram would take to reach the destination network. The maximum metric for RIP is 15. This limits the size of the network that RIP can support. Smaller metrics are more efficient based on the cost associated with each metric.

RIP protocol is most useful as an Interior Gateway Protocol (IGP). An IGP refers to the routing protocol used within a single autonomous system. There may be a number of autonomous systems, using different routing protocols, combined together to form a large network. In most networking environments, RIP is not the preferred choice for routing as its time to converge and scalability are poor compared to EIGRP or OSPF.

21.1. RIP Characteristics

RIP is a standardised distance vector protocol, designed for use on smaller networks. RIP was one of the first true distance vector routing protocols, and is supported on a wide variety of systems.

RIP adheres to the following distance vector characteristics:

- RIP sends out periodic routing updates, every 30 seconds
- RIP sends out the full routing table every periodic update
- RIP uses a form of distance as its metric, in this case, hopcount
- RIP uses the Bellman-Ford distance vector algorithm to determine the best path to a particular destination

Other characteristics of RIP include:

- RIP supports IP and IPX routing
- RIP utilises UDP port 520
- RIP routes have an administrative distance of 120
- RIP has a maximum hopcount of 15 hops. Any network that is 16 hops away or more is considered unreachable to RIP, thus the maximum diameter of the network is 15 hops. A metric of 16 hops in RIP is considered a poison route or infinity metric.

If multiple paths exist to a particular destination, RIP will load balance between those paths, by default, up to 4, only if the metric (hopcount) is equal. RIP uses a round-robin system of load balancing between equal metric routes, which can lead to pinhole congestion.

For example, two paths might exist to a particular destination, one going through a 9600 baud link, the other via a T1. If the metric (hopcount) is equal, RIP will load balance, sending an equal amount of traffic down the 9600 baud link and the T1. This will cause the slower link to become congested.

21.2. RIP Versions

RIP has two versions, Version 1 (RIPv1) and Version 2 (RIPv2).

RIPv1 (RFC 1058) is classful, and therefore does not include the subnet mask with its routing table updates. Because of this, RIPv1 does not support Variable Length Subnet Masks (VLSMs). When using RIPv1, networks must be contiguous, and subnets of a major network must be configured with identical subnet masks. Otherwise, route table inconsistencies or worse will occur.

RIPv1 sends updates as broadcasts to address 255.255.255.255.

RIPv2 (RFC 2453) is classless, and therefore does include the subnet mask with its routing table updates. RIPv2 fully supports VLSMs, allowing discontinuous networks and varying subnet masks to exist.

Other enhancements offered by RIPv2 include:

- Routing updates are sent via multicast, using address 224.0.0.9
- Encrypted authentication can be configured between RIPv2 routers
- Route tagging is supported

RIPv2 can interoperate with RIPv1. By default:

- RIPv1 routers will sent only Version 1 packets
- RIPv1 routers will receive both Version 1 and 2 updates
- RIPv2 routers will both send and receive only Version 2 updates

The Merlin's **ripd** package supports RIP version 2 as described in RFC2453 and RIP version 1 as described in RFC1058. It is part of Quagga suite of applications for routing.

21.3. Configuring RIP Using The Web Interface

Configuration package used

Package	Sections
ripd	routing
	interface
	key_chain
	offset

To configure RIP using the web interface, select **Network -> RIP**. The RIP page appears. There are four sections in the RIP page.

Section	Description
Global Settings	Enables RIP and configures the RIP routing section containing global configuration parameters. The web automatically names the routing section ripd
Interfaces Configuration	Configures the interface sections. Defines interface configuration for RIP and interface specific parameters.
Offset Configuration	Configures the offset sections for metric manipulation
MD5 Authentication Key Chains	Configures the key_chain sections. Defines MD5 authentication settings.

RIP global settings

The web browser automatically names the routing section 'ripd'.

RIP

Global Settings

Delete

RIP Enabled

RIP Version

Network/Interface

A, B, C, D/mask or interface name, e.g. 192.168.100.100/24 or gre1

RIP Neighbor Address

A, B, C, D, e.g. 192.168.100.100

Update Timer Every update timer seconds, the RIP process is awakened to send an unsolicited Response message containing the complete routing table to all neighboring RIP routers

Timeout Timer Upon expiration of the timeout, the route is no longer valid, however, it is retained in the routing table for a short time so that neighbors can be notified that the route has been dropped

Garbage Collect Timer Upon expiration, the route is finally removed from the routing table.

Make Default Router

Redistribute Kernel Routes

The RIP global settings configurations page

Web Field/UCI/Package Option	Description				
Web: RIP Enabled UCI: ripd.ripd.enabled Opt: enabled	Enables RIP advertisements on router. <table border="1"> <tr> <td>Default: 0</td> <td>Disabled</td> </tr> <tr> <td>1</td> <td>Enabled</td> </tr> </table>	Default: 0	Disabled	1	Enabled
Default: 0	Disabled				
1	Enabled				
Web: RIP Version UCI: ripd.ripd.version Opt: version	Specifies the RIP version that will be used. Version 2 is recommended. <table border="1"> <tr> <td>1</td> <td>RIP version 1</td> </tr> <tr> <td>Default: 2</td> <td>RIP version 2</td> </tr> </table>	1	RIP version 1	Default: 2	RIP version 2
1	RIP version 1				
Default: 2	RIP version 2				
Web: Network/Interface UCI: ripd.ripd.network Opt: list network	Defines the list of the interfaces that will be used to advertise RIP packets. Format: A.B.C.D/mask or interface name Multiple RIP interfaces are entered using uci set and uci add_list commands. Example: <pre>uci set ripd.ripd.network=lan1 uci add_list ripd.ripd.network=lan2</pre> or using a list of options via package options <pre>list network 'lan1' list network 'lan2'</pre>				
Web: RIP Neighbor Address UCI: ripd.ripd.neighbor Opt: list neighbor	Specifies the list of RIP neighbours. When a neighbour does not understand multicast, this command is used to specify neighbours. In some cases, not all routers will be able to understand multicasting, where packets are sent to a network or a group of addresses. In a situation where a neighbour cannot process multicast packets, it is necessary to establish a direct link between routers. The neighbour command allows the network administrator to specify a router as a RIP neighbour. Multiple RIP neighbours are entered using uci set and uci add_list commands. Example: <pre>uci set ripd.ripd.neighbor=1.1.1.1 uci add_list ripd.ripd.neighbor=2.2.2.2</pre> or using a list of options via package options <pre>list neighbor '1.1.1.1' list neighbor '2.2.2.2'</pre>				
Web: Update Timer UCI: ripd.ripd.tb_update_sec Opt: tb_update_sec	Every update timer seconds, the RIP process is awakened to send an unsolicited response message containing the complete routing table to all neighbouring RIP routers. <table border="1"> <tr> <td>Default</td> <td>30</td> </tr> <tr> <td>Range</td> <td></td> </tr> </table>	Default	30	Range	
Default	30				
Range					
Web: Timeout Timer UCI: ripd.ripd.tb_timeout_sec Opt: tb_timeout_sec	Defines timeout in seconds. Upon expiration of the timeout, the route is no longer valid; however, it is retained in the routing table for a short time so that neighbours can be notified that the route has been dropped. <table border="1"> <tr> <td>Default</td> <td>180</td> </tr> <tr> <td>Range</td> <td></td> </tr> </table>	Default	180	Range	
Default	180				
Range					
Web: Garbage Collect Timer UCI: ripd.ripd.tb_garbage_sec Opt: tb_garbage_sec	Upon expiration of the garbage-collection timer, the route is finally removed from the routing table. This timer starts when Timeout timer expires or when route is advertised as "unreachable". The reason for using this two-stage marking and deleting removal method is to give the router that declared the route no longer reachable a chance to propagate				

Web Field/UCI/Package Option	Description				
	<p>this information to other routers. When the timer expires the route is deleted. If during the garbage collection period a new RIP response for the route is received, then the deletion process is aborted: the garbage- collection timer is cleared, the route is marked as valid again, and a new Timeout timer starts.</p> <table border="1"> <tr> <td>Default</td> <td>120</td> </tr> <tr> <td>Range</td> <td></td> </tr> </table>	Default	120	Range	
Default	120				
Range					
Web: Make Default Router UCI: ripd.ripd.default_info_originate Opt: default_info_originate	Advertising a default route via RIP. <table border="1"> <tr> <td>Default: 0</td> <td>Disabled</td> </tr> <tr> <td>1</td> <td>Enabled</td> </tr> </table>	Default: 0	Disabled	1	Enabled
Default: 0	Disabled				
1	Enabled				
Web: Redistribute Kernel Routes UCI: ripd.ripd.redistribute_kernel_routes Opt: redistribute_kernel_routes	Redistributes routing information from kernel route entries into the RIP tables. <table border="1"> <tr> <td>Default: 0</td> <td>Disabled</td> </tr> <tr> <td>1</td> <td>Enabled</td> </tr> </table>	Default: 0	Disabled	1	Enabled
Default: 0	Disabled				
1	Enabled				
Web: n/a UCI: ripd.ripd.vty_enabled Opt: vty_enabled	Enable vty for RIPd (telnet to localhost:2602).				

21.3.1. RIP Interfaces Configuration

Interfaces Configuration

Interface	Split Horizon	Poison Reverse	Passive	Authentication	Text Auth. Key	MD5 Key Chain Name	
<i>RIPv2 only</i>							
lan	<input checked="" type="checkbox"/>	<input checked="" type="checkbox"/>	<input checked="" type="checkbox"/>	no			Delete
lan2	<input checked="" type="checkbox"/>	<input type="checkbox"/>	<input type="checkbox"/>	text	secret		Delete
lan3	<input checked="" type="checkbox"/>	<input type="checkbox"/>	<input type="checkbox"/>	md5		chain	Delete

Add

The RIP interfaces configuration page

Web Field/UCI/Package Option	Description						
Web: Interface UCI: ripd.@interface[0].rip_interface Opt: rip_interface	Specifies the interface name.						
Web: Split Horizon UCI: ripd.@interface[0].split_horizon Opt: split_horizon	Prohibits the router from advertising a route back onto the interface from which it was learned. <table border="1"><tr><td>0</td><td>Disabled</td></tr><tr><td>Default: 1</td><td>Enabled</td></tr></table>	0	Disabled	Default: 1	Enabled		
0	Disabled						
Default: 1	Enabled						
Web: Poison Reverse UCI: ripd.@interface[0].poison_reverse Opt: poison_reverse	Router tells its neighbour gateways that one of the gateways is no longer connected. Notifies the gateway, setting the hop count to the unconnected gateway to 16 which would mean "infinite". <table border="1"><tr><td>Default: 0</td><td>Disabled</td></tr><tr><td>1</td><td>Enabled</td></tr></table>	Default: 0	Disabled	1	Enabled		
Default: 0	Disabled						
1	Enabled						
Web: Passive UCI: ripd.@interface[0].passive Opt: passive	Sets the specified interface to passive mode. On passive mode interface, all receiving packets are processed as normal and ripd does not send either multicast or unicast RIP packets except to RIP neighbour specified with a neighbour command. <table border="1"><tr><td>Default: 0</td><td>Disabled</td></tr><tr><td>1</td><td>Enabled</td></tr></table>	Default: 0	Disabled	1	Enabled		
Default: 0	Disabled						
1	Enabled						
Web: Authentication UCI: ripd.@interface[0].auth_mode Opt: auth_mode	RIPv2 (only) allows packets to be authenticated via either an insecure plain text password, included with the packet, or via a more secure MD5 based HMAC (keyed-Hashing for Message AuthentiCation). Enabling authentication prevents routes being updated by unauthenticated remote routers, but still can allow routes, that is, the entire RIP routing table, to be queried remotely, potentially by anyone on the internet, via RIPv1. <table border="1"><tr><td>Default: no</td><td>No authentication.</td></tr><tr><td>md5</td><td>Sets the interface with RIPv2 MD5 authentication.</td></tr><tr><td>text</td><td>Sets the interface with RIPv2 simple password authentication.</td></tr></table>	Default: no	No authentication.	md5	Sets the interface with RIPv2 MD5 authentication.	text	Sets the interface with RIPv2 simple password authentication.
Default: no	No authentication.						
md5	Sets the interface with RIPv2 MD5 authentication.						
text	Sets the interface with RIPv2 simple password authentication.						
Web: Text Auth. Key UCI: ripd.@interface[0].auth_key Opt: auth_key	This command sets the authentication string for text authentication. The string must be shorter than 16 characters.						
Web: MD5 Key Chain Name UCI: ripd.@interface[0].key_chain Opt: key_chain	Specify Keyed MD5 chain.						

21.3.2. Offset Configuration

This section is used for RIP metric manipulation. RIP metric is a value for distance in the network. Usually, ripd package increments the metric when the network information is received. Redistributed routes' metric is set to 1.

Offset Configuration Delete

Metric

Match

Add

The RIP offset configuration section

Web Field/UCI/Package Option	Description		
Web: Metric UCI: ripd.@offset[0].metric Opt: metric	Defines the metric offset value. This modifies the default metric value for redistributed and connected routes. <div style="border: 1px solid black; padding: 2px; width: fit-content;"> <table border="1"> <tr><td>1</td></tr> <tr><td>Range</td></tr> </table> </div>	1	Range
1			
Range			
Web: Match UCI: ripd.@offset[0].match_network Opt: match_network	Defines the prefixes to match. Format: A.B.C.D/mask		

21.3.3. MD5 Authentication Key Chains

RIPv2 (only) allows packets to be authenticated using either an insecure plain text password, included with the packet, or by a more secure MD5 based HMAC (keyed- Hashing for Message Authentication). Enabling authentication prevents routes being updated by unauthenticated remote routers, but still can allow routes, that is, the entire RIP routing table, to be queried remotely, potentially by anyone on the internet, using RIPv1.

This section defines key_chains to be used for MD5 authentication.

MD5 Authentication Key Chains

Key Chain Name

Key ID e.g. 1, 2... Must be unique and match at both ends

Authentication key

The MD5 authentication key chains configuration section

Web Field/UCI/Package Option	Description
Web: Key Chain Name UCI: ripd.@key_chain[0].key_chain_name Opt: key_chain_name	Specifies the chain name.
Web: Key ID UCI: ripd.@key_chain[0].key_id Opt: key_id	Specifies the key ID. Must be unique and match at both ends.
Web: Authentication key UCI: ripd.@key_chain[0].auth_key Opt: auth_key	Specifies the keyed MD5 chain.

21.4. Configuring RIP Using Command Line

RIP is configured under the ripd package `/etc/config/ripd`.

There are four config sections ripd, interface, key_chain and offset. You can configure multiple interface, key_chain and offset sections.

By default, all RIP interface instances are named interface, it is identified by @interface then the interface position in the package as a number. For example, for the first interface in the package using UCI:

```
ripd.@interface[0]=interface
ripd.@interface[0].rip_interface=lan
```

Or using package options:

```
config interface
option rip_interface 'lan'
```

By default, all RIP `key_chain` instances are named `key_chain`, it is identified by `@key_chain` then the `key_chain` position in the package as a number. For example, for the first `key_chain` in the package using UCI:

```
ripd.@key_chain[0]=key_chain
ripd.@key_chain[0].key_chain_name=Keychain1
```

Or using package options:

```
config key_chain
option key_chain_name 'Keychain1'
```

By default, all RIP `offset` instances are named `offset`, it is identified by `@offset` then the `offset` position in the package as a number. For example, for the first `offset` in the package using UCI:

```
ripd.@offset[0]=offset
ripd.@offset[0].metric=1
```

Or using package options:

```
config offset
option metric '1'
```

21.4.1. RIP Using UCI

```
root@VA_router:~# uci show ripd
ripd.ripd=routing
ripd.ripd.version=2
ripd.ripd.enabled=yes
ripd.ripd.network=lan2 gre1
ripd.ripd.neighbor=10.1.1.100 10.1.2.100
ripd.ripd.tb_update_sec=30
ripd.ripd.tb_timeout_sec=180
ripd.ripd.tb_garbage_sec=120
ripd.ripd.default_info_originate=yes
ripd.ripd.redistribute_kernel_routes=yes
ripd.@interface[0]=interface
ripd.@interface[0].rip_interface=lan
ripd.@interface[0].auth_mode=no
ripd.@interface[0].split_horizon=1
ripd.@interface[0].poison_reverse=0
ripd.@interface[0].passive=0
ripd.@interface[1]=interface
ripd.@interface[1].rip_interface=lan2
ripd.@interface[1].split_horizon=1
ripd.@interface[1].poison_reverse=0
ripd.@interface[1].passive=0
ripd.@interface[1].auth_mode=text
ripd.@interface[1].auth_key=secret
```

```
ripd.@interface[2]=interface
ripd.@interface[2].rip_interface=lan3
ripd.@interface[2].split_horizon=1
ripd.@interface[2].poison_reverse=0
ripd.@interface[2].passive=0
ripd.@interface[2].auth_mode=md5
ripd.@interface[2].key_chain=Keychain1
ripd.@key_chain[0]=key_chain
ripd.@key_chain[0].key_chain_name=Keychain1
ripd.@key_chain[0].key_id=1
ripd.@key_chain[0].auth_key=123
ripd.@offset[0]=offset
ripd.@offset[0].metric=1
ripd.@offset[0].match_network=10.1.1.1/24
```

21.4.2. RIP Using Package Options

```
root@VA_router:~# uci export ripd
package ripd
config routing 'ripd'
option version '2'
option enabled 'yes'
list network 'lan2'
list network 'gre1'
list neighbor '10.1.1.100'
list neighbor '10.1.2.100'
option tb_update_sec '30'
option tb_timeout_sec '180'
option tb_garbage_sec '120'
option default_info_originate 'yes'
option redistribute_kernel_routes 'yes'
config interface
```

```
option rip_interface 'lan'  
option auth_mode 'no'  
option split_horizon '1'  
option poison_reverse '0'  
option passive '0'  
  
config interface  
option rip_interface 'lan2'  
option split_horizon '1'  
option poison_reverse '0'  
option passive '0'  
option auth_mode 'text'  
option auth_key 'textsecret'  
  
config interface  
option rip_interface 'lan3'  
option split_horizon '1'  
option poison_reverse '0'  
option passive '0'  
option auth_mode 'md5'  
option key_chain 'keychain1'  
config key_chain  
option key_chain_name 'Keychain1'  
option key_id '1'  
option auth_key '123'  
  
config offset  
option metric '1'  
option match_network '10.1.1.1/24'
```

21.5. RIP Diagnostics

Route Status

To show the current routing status, enter:

```
root@VA_router:~# route -n
```

Kernel IP routing table							
Destination	Gateway	Genmask	Flags	Metric	Ref	Use	Iface
0.0.0.0	10.206.4.65	0.0.0.0	UG	1	0	0	usb0
10.1.0.0	0.0.0.0	255.255.0.0	U	0	0	0	eth1
10.206.4.64	0.0.0.0	255.255.255.252	U	0	0	0	usb0
11.11.11.0	0.0.0.0	255.255.255.248	U	0	0	0	gre-GRE
89.101.154.151	10.206.4.65	255.255.255.255	UGH	0	0	0	usb0
192.168.100.0	0.0.0.0	255.255.255	U	0	0	0	eth0
192.168.101	11.11.11.1	255.255.255.255	UGH	11	0	0	gre-GRE
192.168.104.1	11.11.11.4	255.255.255.255	UGH	20	0	0	gre-GRE

Note: a route will only be displayed in the routing table when the interface is up.

21.5.1. Tracing RIP Packets

RIP uses UDP port 520. To trace RIP packets on any interface on the router, enter:

`tcpdump -i any -n -p port 520 &`

```
root@VA_router:~# tcpdump -i any -n -p port 520 &
tcpdump: verbose output suppressed, use -v or -vv for full protocol decode
listening on any, link-type LINUX_SLL (Linux cooked), capture size 65535 bytes
```

To stop tracing enter **fg** to bring tracing task to foreground, and then **<CTRL-C>** to stop the trace.

```
root@VA_router:~# fg
tcpdump -i any -n -p port 67
^C
33 packets captured
33 packets received by filter
0 packets dropped by kernel
```

21.5.2. Quagga/Zebra Console RIP

Quagga is the routing protocol suite embedded in the router firmware. Quagga is split into different daemons for implementation of each routing protocol. Zebra is a core daemon for Quagga, providing the communication layer to the underlying Linux kernel, and routing updates to the client daemons.

Quagga has a console interface to Zebra for advanced debugging of the routing protocols.

To access, enter: `telnet localhost zebra` (password: zebra)

```
root@VA_router:~# telnet localhost zebra
Entering character mode Escape character is '^]'.
Hello, this is Quagga (version 0.99.21).
Copyright 1996-2005 Kunihiro Ishiguro, et al.
User Access Verification
Password:
```

To see RIP routing information from Zebra console, enter:

```

root@VA_router:~# sh ip route

Codes: K - kernel route, C - connected, S - static, R - RIP,
O - OSPF, I - IS-IS, B - BGP, P - PIM, H - HSLs, o - OLSR, b - BATMAN, A - Babel,
> - selected route, * - FIB route

K>* 0.0.0.0/0 via 10.205.154.65, usb0

C>* 10.1.0.0/16 is directly connected, eth1

C>* 10.205.154.64/30 is directly connected, usb0 C>* 11.11.11.0/29 is directly connected, gre-GRE K>* 89.101.154.151/32 via
10.205.154.65, usb0

C>* 127.0.0.0/8 is directly connected, lo

C>* 192.168.100.0/24 is directly connected, eth0

R>* 192.168.104.1/32 [120/3] via 11.11.11.4, gre-GRE, 15:54:47

```

```

C>* 192.168.105.1/32 is directly connected, lo

R>* 192.168.154.154/32 [120/2] via 11.11.11.1, gre-GRE, 16:09:51

```

21.5.3. RIP Debug Console

When option `vtty_enabled` (see Global settings section above) is enabled in the RIP configuration, RIP debug console can be accessed for advanced RIP debugging.

To access RIP debug console enter: `telnet localhost ripd` (password zebra)

```

root@VA_router:~# telnet localhost ripd

Entering character mode Escape character is '^]'.

Hello, this is Quagga (version 0.99.21). Copyright 1996-2005 Kunihiro Ishiguro, et al.

User Access Verification

Password:

```

To see RIP status from RIP debug console, enter:

```

root@VA_router:~# show ip rip

Codes: R - RIP, C - connected, S - Static, O - OSPF, B - BGP

Sub-codes:

(n) - normal, (s) - static, (d) - default, (r) - redistribute,

(i) - interface

```

Network	Next Hop	Metric From	Tag Time
C(i) 11.11.11.0/29	0.0.0.0	1 self	0
R(n) 192.168.104.1/32	11.11.11.4	3 11.11.11.1	0 02:48
C(i) 192.168.105.1/32	0.0.0.0	1 self	0
R(n) 192.168.154.154/32	11.11.11.1	2 11.11.11.1	0 02:48

To see RIP status from RIP debug console, enter:

```
root@VA_router:~# sh ip rip status
Routing Protocol is "rip"
Sending updates every 30 seconds with +/-50%, next due in 17 seconds
Timeout after 180 seconds, garbage collect after 120 seconds
Outgoing update filter list for all interface is not set
Incoming update filter list for all interface is not set
Default redistribution metric is 1
Redistributing:
Default version control: send version 2, receive version 2
Interface Send Recv Key-chain
gre-GRE 2 2
lo 2 2
Routing for Networks:
11.0.0.0/8
192.168.105.1/32
Routing Information Sources:
Gateway BadPackets BadRoutes Distance Last Update
11.11.11.1 0 0 120 00:00:20
Distance: (default is 120)
```

22. Configuring PIM And IGMP Interfaces

IP multicast is a bandwidth-conserving technology that reduces traffic by simultaneously delivering a single stream of information to potentially thousands of corporate recipients. Applications that take advantage of multicast include video conferencing and corporate communications.

IP multicast delivers application source traffic to multiple receivers without burdening the source or the receivers while using a minimum of network bandwidth.

PIM (Protocol Independent Multicast) and IGMP (Internet Group Management Protocol) are protocols used to create multicasting networks within a regular IP network.

A multicast group is an arbitrary group of receivers that expresses an interest in receiving a particular data stream. The receivers (the designated multicast group) are interested in receiving a data stream from the source. They indicate this by sending an Internet Group Management Protocol (IGMP) host report to their closest router in the network. The routers are then responsible for delivering the data from the source to the receivers. The routers use Protocol Independent Multicast (PIM) between themselves to dynamically create a multicast distribution tree. The data stream will then be delivered only to the network segments that are in the path between the source and the receivers. To summarise: PIM is used between routers while IGMP is used between a receiver and its router only. As a result, PIM must be enabled on all the interfaces on the route from the multicast source to the multicast client while IGMP must be enabled on the interface to the multicast client only.

Configuration Package Used

Package	Sections
pimd	pimd interface

22.1. Configuring PIM And IGMP Using The Web Interface

To configure PIM through the web interface, in the top menu, select **Network -> PIM**. The PIM page appears. To access the Global Settings, click **Add**.

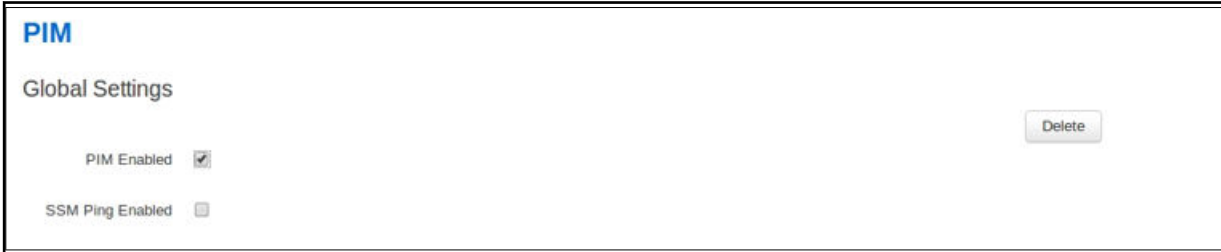

The PIM global settings interface

22.1.1. Global Settings

Web Field/UCI/Package Option	Description				
Web: PIM Enabled UCI: pimd.pimd.enabled Opt: enabled	Globally enables PIM on the router. <table border="1"> <tr> <td>Default: 0</td> <td>Disabled</td> </tr> <tr> <td>1</td> <td>Enabled</td> </tr> </table>	Default: 0	Disabled	1	Enabled
Default: 0	Disabled				
1	Enabled				
Web: SSM Ping Enabled UCI: pimd.pimd.ssm pingd Opt: ssm pingd	Enables answers to SSM pings. <table border="1"> <tr> <td>Default: 0</td> <td>Disabled</td> </tr> <tr> <td>1</td> <td>Enabled</td> </tr> </table>	Default: 0	Disabled	1	Enabled
Default: 0	Disabled				
1	Enabled				

22.1.2. Interfaces Configuration

Web Field/UCI/Package Option	Description				
Web: Enabled UCI: pimd.interface[x].enabled Opt: enabled	Enables multicast management of the given interface by the PIM application. <table border="1"> <tr> <td>Default: 0</td> <td>Disabled</td> </tr> <tr> <td>1</td> <td>Enabled</td> </tr> </table>	Default: 0	Disabled	1	Enabled
Default: 0	Disabled				
1	Enabled				
Web: Interface UCI: pimd.interface[x].interface Opt: interface	Selects the interface to apply PIM settings to.				
Web: Enable IGMP UCI: pimd.interface[x].igmp Opt: igmp	Enable IGMP on given interface. <table border="1"> <tr> <td>Default: 0</td> <td>Disabled</td> </tr> <tr> <td>1</td> <td>Enabled</td> </tr> </table> <p>Note: you must enable PIM SSM and/or IGMP depending on your requirements. ICMP must be enabled on the interface to the multicast client only.</p>	Default: 0	Disabled	1	Enabled
Default: 0	Disabled				
1	Enabled				
Web: Enable SSM UCI: pimd.interface[x].ssm Opt: ssm	Enable SSM on given interface. <table border="1"> <tr> <td>Default: 0</td> <td>Disabled</td> </tr> <tr> <td>1</td> <td>Enabled</td> </tr> </table>	Default: 0	Disabled	1	Enabled
Default: 0	Disabled				
1	Enabled				

To save your configuration updates, click **Save & Apply**.

22.2. Configuring PIM And IGMP Using UCI

You can configure PIM and IGMP through CLI using UCI.

The configuration file is stored on **/etc/config/pimd**

To view the configuration file, enter:

```
root@VA_router:/etc/config1# uci export pimd
package pimd
config routing 'pimd'
option enabled 'yes'

config interface
option enabled 'yes'
option interface 'lan'
option ssm 'yes'
option igmp 'yes'

config interface
option enabled 'yes'
option interface 'wan'
option ssm 'yes'
option igmp 'no'

Alternatively, enter:
uci show pimd
root@VA_router:/etc/config1# uci show pimd
pimd.pimd=routing
pimd.pimd.enabled=yes
pimd.@interface[0]=interface
pimd.@interface[0].enabled=yes
pimd.@interface[0].interface=lan
pimd.@interface[0].ssm=yes
pimd.@interface[0].igmp=yes
pimd.@interface[1]=interface
pimd.@interface[1].enabled=yes
pimd.@interface[1].interface=wan
pimd.@interface[1].ssm=yes
pimd.@interface[1].igmp=no
```

23. Configuring Multi-WAN

Multi-WAN is used for managing WAN interfaces on the router, for example, 3G interfaces to ensure high availability. You can customise Multi-WAN for various needs, but its main use is to ensure WAN connectivity and provide a failover system in the event of failure or poor coverage.

Multi-WAN periodically does a health check on the interface. A health check comprises of a configurable combination of the following:

- interface state
- pings to an ICMP target
- signal level checks using signal threshold, RSCP threshold and ECIO threshold option values

A fail for any of the above health checks, results in a fail. After a configurable number of health check failures, Multi-WAN will move to the next highest priority interface. Multi- WAN will optionally stop the failed interface and start the new interface, if required.

In some circumstances, particularly in mobile environments, it is desirable for a primary interface to be used whenever possible. In this instance Multi-WAN will perform a health check on the primary interface after a configurable period. If the health checks pass for the configured number of recovery health checks then the primary will be used.

Configuration package used

Package	Sections
multiwan	config wan

23.1. Configuring Multi-WAN Using The Web Interface

In the top menu, select **Network -> Multi-Wan**. The Multi-WAN page appears.

Multi-WAN

Multi-WAN allows for the use of multiple uplinks for load balancing and failover.

Enable

Preempt

Alternate Mode  It will use alternate interface after reboot

The multi-WAN page

Web Field/UCI/Package Option	Description				
Web: Enable UCI: multiwan.config.enabled Opt: enabled	Enables or disables Multi-WAN. <table border="1"> <tr> <td>Default: 0</td> <td>Disabled</td> </tr> <tr> <td>1</td> <td>Enabled</td> </tr> </table>	Default: 0	Disabled	1	Enabled
Default: 0	Disabled				
1	Enabled				
Web: Preempt UCI: multiwan.config.preempt Opt: preempt	Enables or disables pre-emption for Multi-WAN. If enabled the router will keep trying to connect to a higher priority interface depending on timer set by ifup_retry_sec <table border="1"> <tr> <td>Default: 0</td> <td>Disabled</td> </tr> <tr> <td>1</td> <td>Enabled</td> </tr> </table>	Default: 0	Disabled	1	Enabled
Default: 0	Disabled				
1	Enabled				
Web: Alternate Mode UCI: multiwan.config.alt_mode Opt: alt_mode	Enables or disables alternate mode for Multi-WAN. If enabled the router will use an alternate interface after reboot. <table border="1"> <tr> <td>Default: 0</td> <td>Disabled</td> </tr> <tr> <td>1</td> <td>Enabled</td> </tr> </table>	Default: 0	Disabled	1	Enabled
Default: 0	Disabled				
1	Enabled				

When you have enabled Multi-WAN, you can add the interfaces that will be managed by Multi-WAN, for example 3G interfaces.

The name used for Multi-WAN must be identical, including upper and lowercases, to the actual interface name defined in your network configuration. To check the names and settings are correct, select **Network -> Interfaces** and view the Interfaces Overview page.

In the WAN interfaces section, enter the name of the WAN interface to configure, and then click **Add**. The new section for configuring specific parameters appears.

WAN Interfaces

Health Monitor detects and corrects network changes and failed connections.

WAN

Health Monitor Interval	<input type="text" value="10 sec."/>	
Health Monitor ICMP Host(s)	<input type="text" value="DNS Server(s)"/>	
Health Monitor Contrack Test Host(s)	<input type="text" value="Default"/>	
Health Monitor ICMP Timeout	<input type="text" value="3 sec."/>	
Health Monitor ICMP Interval	<input type="text" value="1 sec."/>	
Attempts Before WAN Failover	<input type="text" value="3"/>	
Attempts Before WAN Recovery	<input type="text" value="5"/>	
Priority	<input type="text" value="0"/>	? Higher value is higher priority
Exclusive Group	<input type="text" value="0"/>	? Only one interface in group could be up in the same time
Manage Interface State (Up/Down)	<input checked="" type="checkbox"/>	
Minimum ifup Interval	<input type="text" value="300 sec."/>	? Minimum interval between two successive interface start attempts
Interface Start Timeout	<input type="text" value="40 sec."/>	? Time for interface to startup
Signal Threshold (dBm)	<input type="text" value="-115"/>	? Below is a failure
RSCP Threshold for 3G (dBm)	<input type="text" value="-115"/>	? Below is a failure
ECIO Threshold for 3G (dB)	<input type="text" value="-115"/>	? Below is a failure
Signal Test	<input type="text"/>	? Free form expression to test signal value

Example interface showing failover traffic destination as the added multi-WAN interface

Web Field/UCI/Package Option	Description								
Web: Health Monitor Interval UCI: multiwan.wan.health_interval Opt: health_interval	Sets the period to check the health status of the interface. The Health Monitor interval will be used for: <ul style="list-style-type: none"> • Interface state checks • Ping interval • Signal strength checks The health monitor interval has a granularity of 5 seconds. Configured values will be rounded up to the next 5 second value. <table border="1"> <tr> <td>Default: 10</td> <td>Perform a health check every 10 seconds</td> </tr> <tr> <td>Range</td> <td></td> </tr> </table>	Default: 10	Perform a health check every 10 seconds	Range					
Default: 10	Perform a health check every 10 seconds								
Range									
Web: Health Monitor ICMP Host(s) UCI: multiwan.wan.icmp_hosts Opt: icmp_hosts	Sends health ICMPs to configured value DNS servers by default. Configure to any address. <table border="1"> <tr> <td>Disable</td> <td>Disables the option</td> </tr> <tr> <td>Default: DNS servers</td> <td>DNS IP addresses will be used</td> </tr> <tr> <td>WAN Gateway</td> <td>Gateway IP address will be used</td> </tr> <tr> <td>Custom</td> <td>Ability to provide IP address. Multiple pings targets can be entered, comma separated. Pings to both must fail for health check to fail. Example: option icmp_hosts '1.1.1.1,2.2.2.2'</td> </tr> </table>	Disable	Disables the option	Default: DNS servers	DNS IP addresses will be used	WAN Gateway	Gateway IP address will be used	Custom	Ability to provide IP address. Multiple pings targets can be entered, comma separated. Pings to both must fail for health check to fail. Example: option icmp_hosts '1.1.1.1,2.2.2.2'
Disable	Disables the option								
Default: DNS servers	DNS IP addresses will be used								
WAN Gateway	Gateway IP address will be used								
Custom	Ability to provide IP address. Multiple pings targets can be entered, comma separated. Pings to both must fail for health check to fail. Example: option icmp_hosts '1.1.1.1,2.2.2.2'								
Web: Health Monitor Contrack Test Host(s) UCI: multiwan.wan.contrack_hosts Opt: contrack_hosts	Contrack is the feature used to track if there is any traffic to and from an IP destination within the health interval. <p>The Contrack_hosts option defines the IP for contrack to track, usually the icmp_host IP is used.</p> <p>If traffic to the contrack_hosts IP is detected then multiwan does not send a ping health check to the icmp_host; otherwise a ping is sent as normal to the icmp_host.</p> <p>By default the contrack_hosts is checked if the health interval is greater than 5 minutes. This time threshold currently cannot be manipulated.</p> <p>Contrack is generally used to limit the traffic sent on a GSM network.</p> <table border="1"> <tr> <td>Default</td> <td>Contrack checks for traffic from icmp_host IP when health_interval is greater than 5 minutes.</td> </tr> <tr> <td>Disable</td> <td>Contrack disabled.</td> </tr> <tr> <td>Custom</td> <td>Specifies an IP other than the icmp_host for contrack to track.</td> </tr> </table>	Default	Contrack checks for traffic from icmp_host IP when health_interval is greater than 5 minutes.	Disable	Contrack disabled.	Custom	Specifies an IP other than the icmp_host for contrack to track.		
Default	Contrack checks for traffic from icmp_host IP when health_interval is greater than 5 minutes.								
Disable	Contrack disabled.								
Custom	Specifies an IP other than the icmp_host for contrack to track.								
Web: Health Monitor ICMP Timeout UCI: multiwan.wan.timeout Opt: timeout	Sets Ping timeout in seconds. Choose the time in seconds that the health monitor ICMP will timeout at. <table border="1"> <tr> <td>Default: 3</td> <td>Wait 3 seconds for ping reply.</td> </tr> <tr> <td>Range</td> <td></td> </tr> </table>	Default: 3	Wait 3 seconds for ping reply.	Range					
Default: 3	Wait 3 seconds for ping reply.								
Range									
Web: Health Monitor ICMP Interval UCI: multiwan.wan.icmp_interval Opt: icmp_interval	Defines the interval between multiple pings sent at each health check <table border="1"> <tr> <td>Default</td> <td>1</td> </tr> <tr> <td>Range</td> <td></td> </tr> </table>	Default	1	Range					
Default	1								
Range									
Web: Health Monitor ICMP Count UCI: multiwan.wan.icmp_count Opt: icmp_count	Defines the number of pings to send at each health check. <table border="1"> <tr> <td>Default</td> <td>1</td> </tr> <tr> <td>Range</td> <td></td> </tr> </table>	Default	1	Range					
Default	1								
Range									
Web: Attempts Before WAN Failover UCI: multiwan.wan.health_fail_retries Opt: health_fail_retries	Sets the amount of health monitor retries before the interface is considered a failure. <table border="1"> <tr> <td>Default</td> <td>3</td> </tr> <tr> <td>Range</td> <td></td> </tr> </table>	Default	3	Range					
Default	3								
Range									

Web Field/UCI/Package Option	Description				
Web: Attempts Before WAN Recovery UCI: multiwan.wan.health_recovery_retries Opt: health_recovery_retries	Sets the number of health monitor checks before the interface is considered healthy. Only relevant if pre-empt mode is enabled. <table border="1"> <tr> <td>Default</td> <td>5</td> </tr> <tr> <td>Range</td> <td></td> </tr> </table>	Default	5	Range	
Default	5				
Range					
Web: Priority UCI: multiwan.wan.priority Opt: priority	Specifies the priority of the interface. The higher the value, the higher the priority. <table border="1"> <tr> <td>Default</td> <td>0</td> </tr> <tr> <td>Range</td> <td></td> </tr> </table>	Default	0	Range	
Default	0				
Range					
Web: Manage Interface State (Up/Down) UCI: multiwan.wan.manage_state Opt: manage_state	Defines whether multi-wan will start and stop the interface. <table border="1"> <tr> <td>Default: 0</td> <td>Disabled</td> </tr> <tr> <td>1</td> <td>Enabled</td> </tr> </table>	Default: 0	Disabled	1	Enabled
Default: 0	Disabled				
1	Enabled				
Web: Exclusive Group UCI: multiwan.wan.exclusive_group Opt: exclusive_group	Defines the group to which the interface belongs; only one interface can be active. <table border="1"> <tr> <td>Default</td> <td>0</td> </tr> <tr> <td>Range</td> <td></td> </tr> </table>	Default	0	Range	
Default	0				
Range					
Web: Minimum ifup Interval UCI: multiwan.wan.ifup_retry_sec Opt: ifup_retry_sec	Specifies the interval in seconds before retrying the primary interface when pre-empt mode is enabled. <table border="1"> <tr> <td>Default: 300</td> <td>Retry primary interface every 300 seconds</td> </tr> <tr> <td>1</td> <td>Enabled</td> </tr> </table>	Default: 300	Retry primary interface every 300 seconds	1	Enabled
Default: 300	Retry primary interface every 300 seconds				
1	Enabled				
Web: Interface Start Timeout UCI: multiwan.wan.ifup_timeout Opt: ifup_timeout	Specifies the time in seconds for interface to start up. If it is not up after this period, it will be considered a fail. <table border="1"> <tr> <td>Default</td> <td>40 seconds</td> </tr> <tr> <td>Range</td> <td></td> </tr> </table>	Default	40 seconds	Range	
Default	40 seconds				
Range					
Web: Signal Threshold (dBm) UCI: multiwan.wan.signal_threshold Opt: signal_threshold	Specifies the minimum signal strength in dBm before considering if the interface fails signal health check. Uses the value stored for sig_dbm in mobile diagnostics.-115. <table border="1"> <tr> <td>Default</td> <td>Disabled</td> </tr> <tr> <td>Range</td> <td>-46 to -115 dBm</td> </tr> </table>	Default	Disabled	Range	-46 to -115 dBm
Default	Disabled				
Range	-46 to -115 dBm				
Web: RSCP Threshold (dBm) UCI: multiwan.wan.rscp_threshold Opt: rscp_threshold	Specifies the minimum RSCP signal strength in dBm before considering if the interface fails signal health check. Uses the value stored for rscp_dbm in mobile diagnostics. <table border="1"> <tr> <td>Default</td> <td>-115 Disabled</td> </tr> <tr> <td>Range</td> <td>-46 to -115 dBm</td> </tr> </table>	Default	-115 Disabled	Range	-46 to -115 dBm
Default	-115 Disabled				
Range	-46 to -115 dBm				
Web: ECIO Threshold (dB) UCI: multiwan.wan.ecio_threshold Opt: ecio_threshold	Specifies the minimum ECIO signal strength in dB before considering if the interface fails signal health check. Uses the value stored for ecio_db in mobile diagnostics. <table border="1"> <tr> <td>Default</td> <td>-115 Disabled</td> </tr> <tr> <td>Range</td> <td>-46 to -115 dBm</td> </tr> </table>	Default	-115 Disabled	Range	-46 to -115 dBm
Default	-115 Disabled				
Range	-46 to -115 dBm				
Web: Signal Test UCI: multiwan.wan.signal_test Opt: signal_test	Defines a script to test various signal characteristics in multiwan signal test. For example: <pre>option signal_test '(tech == 0) then (sig_dbm > -70) else (rscp_dbm > -105 and ecio_db > -15)'</pre> <p>This states that when technology is GSM, a health fail is determined when signal strength is less than -70dBm. When technology is not GSM a health fail occurs when either rscp_dbm falls below -105dBm or ecio_db falls below -15dB</p> <p>Note: a signal test can also take a UDS script name as a parameter, for example: <pre>option signal_test `uds(script_name)`</pre></p>				

Web Field/UCI/Package Option	Description																
	Tech values are: <table border="1" data-bbox="632 286 935 564"> <tbody> <tr> <td>0</td> <td>GSM</td> </tr> <tr> <td>1</td> <td>GSM Compact</td> </tr> <tr> <td>2</td> <td>UTRAN</td> </tr> <tr> <td>3</td> <td>GSM W/EGPRS</td> </tr> <tr> <td>4</td> <td>UTRAN w/HSPDA</td> </tr> <tr> <td>5</td> <td>UTRAN w/HSUPA</td> </tr> <tr> <td>6</td> <td>UTRAN W/HSUPA and HSDPA</td> </tr> <tr> <td>7</td> <td>E-UTRAN</td> </tr> </tbody> </table>	0	GSM	1	GSM Compact	2	UTRAN	3	GSM W/EGPRS	4	UTRAN w/HSPDA	5	UTRAN w/HSUPA	6	UTRAN W/HSUPA and HSDPA	7	E-UTRAN
0	GSM																
1	GSM Compact																
2	UTRAN																
3	GSM W/EGPRS																
4	UTRAN w/HSPDA																
5	UTRAN w/HSUPA																
6	UTRAN W/HSUPA and HSDPA																
7	E-UTRAN																

23.2. Configuring Multi-WAN Using UCI

Multi-WAN UCI configuration settings are stored on `/etc/config/multiwan`.

Run `UCI export` or `show` commands to see multiwan UCI configuration settings. A sample is shown below.

```
root@VA_router:~# uci export multiwan

package multiwan

config multiwan 'config'
option preempt 'yes'
option alt_mode 'no'
option enabled 'yes'

config interface 'wan'
option disabled '0'
option health_interval '10'
option health_fail_retries '3'
option health_recovery_retries '5'
option priority '2'
option manage_state 'yes'
option exclusive_group '0'
option ifup_retry_sec '40' option icmp_hosts 'disable' option icmp_interval '1'
option timeout '3'
option icmp_count '1'
option conntrack_hosts 'disable' option signal_threshold '- 111'
option rscp_threshold '-90'
option ecio_threshold '-15'
option ifup_timeout_sec '120'

root@VA_router:~# uci show multiwan

multiwan.config=multiwan
multiwan.config.preempt=yes
multiwan.config.alt_mode=no
multiwan.config.enabled=yes
multiwan.wan=interface
multiwan.wan.disabled=0
multiwan.wan.health_interval=10multiwan.wan.health_fail_retries=3
multiwan.wan.health_recovery_retries=5
multiwan.wan.priority=2
multiwan.wan.manage_state=yes
multiwan.wan.exclusive_group=0
multiwan.wan.timeout '3'
multiwan.wan.icmp_count '1'
```

```
multiwan.wan.contrack_hosts 'disable'  
  
multiwan.wan.signal_threshold=-111  
  
multiwan.wan.rscp_threshold=-90  
  
multiwan.wan.ecio_threshold=-15
```

23.3. Multi-WAN Diagnostics

The multiwan package is linked to the network interfaces within `/etc/config/network`.



NOTE

Multi-WAN will not work if the WAN connections are on the same subnet and share the same default gateway.

To view the multiwan package, enter:

```
root@VA_router:~# uci export multiwan
package multiwan

config multiwan 'config'
option enabled 'yes'
option preempt 'yes'
option alt_mode 'no'

config interface 'ADSL'
option health_interval '10'
option icmp_hosts 'dns'
option timeout '3'
option health_fail_retries '3'
option health_recovery_retries '5'
option priority '1'
option manage_state 'yes'
option exclusive_group '0'
option ifup_retry_sec '300'
option ifup_timeout_sec '40'

config interface 'Ethernet'
option health_interval '10'
option icmp_hosts 'dns'
option timeout '3'
option health_fail_retries '3'
option health_recovery_retries '5'
option priority '2'
option manage_state 'yes'
option exclusive_group '0'
option ifup_retry_sec '300'
option ifup_timeout_sec '40'
```

The following output shows the multiwan standard stop/start commands for troubleshooting.

```
root@VA_router:~# /etc/init.d/multiwan
Syntax: /etc/init.d/multiwan [command]
```

Available commands:

```
start Start the service
stop Stop the service
restart Restart the service
reload Reload configuration files (or restart if that fails)
enable Enable service autostart
disable Disable service autostart
```

When troubleshooting, make sure that the routing table is correct using **route -n**.

Ensure all parameters in the multiwan package are correct. The name used for Multi- WAN interfaces must be identical, including upper and lowercases, to the interface name defined in the network configuration.

To check the names and settings are correct, browse to **Network -> interfaces** (or alternatively, run: `cat/etc/config/network` through CLI).

Enter the name of the WAN interface to configure, and then click **Add**. The new section for configuring specific parameters will appear.

24. Automatic Operator Selection

This section describes how to configure and operate the Automatic Operator Selection feature of the Merlin router.

When the roaming SIM is connected, the radio module has the ability to scan available networks. The router, using mobile and multiwan packages, finds available networks to create and sort interfaces according to their signal strength. These interfaces are used for failover purposes.

Configuration Package Used

Package	Sections
Multiwan	General, interfaces
Mobile	Main, template interfaces
Network	2G/3G/4G interface

24.1. Configuring Automatic Selection Via The Web Interface

While the router boots up it checks for mobile networks. Based on available networks, the router creates interfaces and the multiwan package is used to run failover between interfaces. Typically these auto-generated interfaces are sorted by signal strength.

Details for these interfaces are provided in the mobile package. When you have created the interfaces, Multi-WAN manages the operation of primary (predefined) and failover (auto created) interfaces.

Multi-WAN periodically does a health check on the active interface. A health check comprises of a configurable combination of the following:

- interface state
- pings to an ICMP target
- signal level checks using signal threshold, RSCP threshold and ECIO threshold option values

A fail for any of the above health checks results in an overall fail. After a configurable number of health check failures, multiwan will move to the next highest priority interface. Multi-WAN will optionally stop the failed interface and start the new interface, if required.

In some circumstances, particularly in mobile environments, it is desirable for a primary interface to be used whenever possible. In this instance, if the active interface is a not the primary interface, multiwan will perform a health check on the primary interface after a configurable period. If the health checks pass for the configured number of recovery health checks then the primary interface will be used.

There are typically three scenarios:

- Primary Mobile Provider (PMP) + roaming: pre-empt enabled
- PMP + roaming: pre-empt disabled
- No PMP + roaming

24.1.1. Scenario 1: PMP + Roaming: Pre-Empt Enabled

Overview

In this scenario, the PMP interface is used whenever possible.

The PMP interface is attempted first. When the health checks fail on the PMP interface, and Multi-WAN moves to an autogenerated interface, a timer is started multiwan option `ifup_retry_sec`. On expiration of this timer, multiwan will disconnect the current interface and retry the PMP interface.

The PMP interface will then be used if the configurable number of health checks pass the checks.

Software operation

1. multiwan first attempts to bring up the PMP interface. If the PMP interface connects within the time set by multiwan option ifup_timeout continue to step 2. Otherwise go to step 4.
2. A health check is periodically done on the PMP interface as determined by the multiwan option health_interval. If the health check fails for the number of retries (multiwan option health_fail_retries), disconnect the PMP interface.
3. Connect the first auto-generated interface. If the interface connects within the time set by multiwan option ifup_timeout continue to step 5, otherwise multiwan moves to the next auto-generated interface.
4. Wait until the health check fails on the auto-generated interface, or until the PMP interface is available to connect after it was disconnected in step 2. (multiwan option ifup_retry_sec).
5. Disconnect auto-generated interface.
6. If the interface was disconnected due to health check failure then connect the next auto-generated interface and repeat step 4. If the interface was disconnected because ifup_retry_sec of PMP interface timed out, then go back to step 1 and repeat the process.

The PMP predefined interface is defined in the network package. Ensure the interface name matches the interface name defined in the multiwan package.

Create a primary predefined interface

In the web interface top menu, go to **Network -> Interfaces**. The Interfaces page appears.

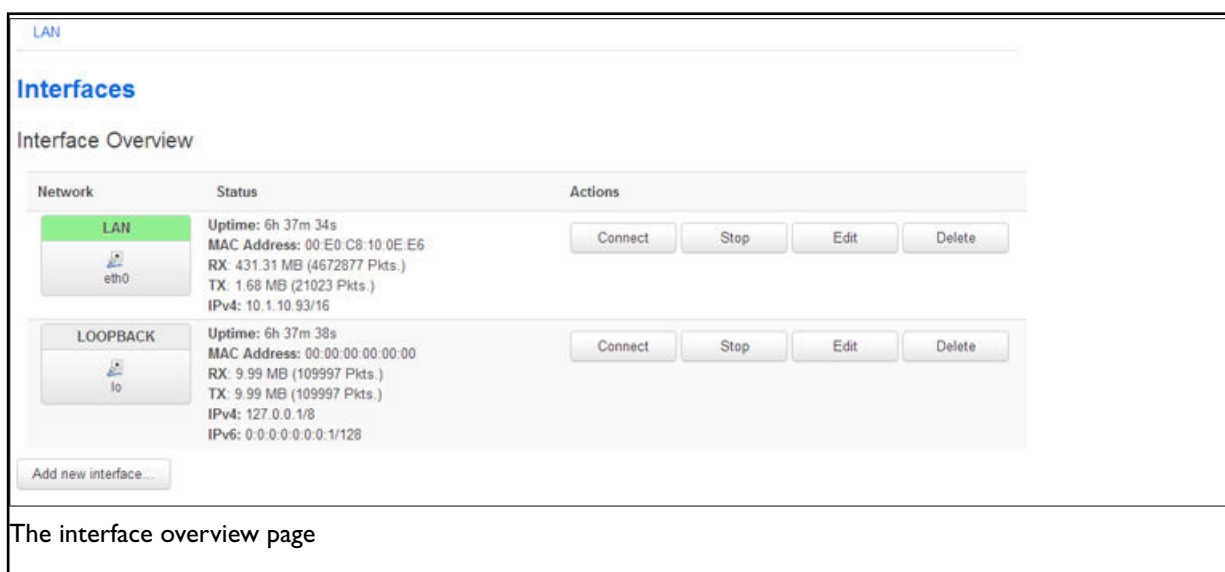

The interface overview page

Click **Add new interface...** The create Interface page appears.

Create Interface

Name of the new interface

The allowed characters are: A-Z, a-z, 0-9 and _

Protocol of the new interface

Create a bridge over multiple interfaces

Cover the following interface

- Ethernet Adapter: "eth0" (lan)
- Ethernet Adapter: "gre0"
- Ethernet Adapter: "lo" (loopback)
- Custom Interface:

Note: If you choose an interface here which is part of another network, it will be moved into this network.

The create interface page

Web Field/UCI/Package Option	Description																										
<p>Web: Name of the new interface</p> <p>UCI: network.3g_s<sim-number>_<short-operator-name></p> <p>Opt: 3g_<sim-number>_<short-operator-name></p>	<p>Type the name of the new interface. Type the interface name in following format: 3g_s<sim-number>_<short-operator-name>. Where<sim-number> is number of roaming SIM (1 or 2) and <short-operator-name> is first four alphanumeric characters of operator name (as reported by 'AT+COPS=?' command). Type the short operator name in lower case, for example:</p> <table border="1"> <thead> <tr> <th>Operator name</th> <th>First four alphanumeric numbers</th> </tr> </thead> <tbody> <tr> <td>Vodafone UK</td> <td>voda</td> </tr> <tr> <td>02 -UK</td> <td>o2uk</td> </tr> <tr> <td>Orange</td> <td>oran</td> </tr> </tbody> </table>	Operator name	First four alphanumeric numbers	Vodafone UK	voda	02 -UK	o2uk	Orange	oran																		
Operator name	First four alphanumeric numbers																										
Vodafone UK	voda																										
02 -UK	o2uk																										
Orange	oran																										
<p>Web: Protocol of the new interface</p> <p>UCI: network[.x.].proto</p> <p>Opt: proto</p>	<p>Protocol type. Select LTE/UMTS/GPRS/EV-DO.</p> <table border="1"> <thead> <tr> <th>Option</th> <th>Description</th> </tr> </thead> <tbody> <tr> <td>Static</td> <td>Static configuration with fixed address and netmask.</td> </tr> <tr> <td>DHCP Client</td> <td>Address and netmask are assigned by DHCP.</td> </tr> <tr> <td>Unmanaged</td> <td>Unspecified</td> </tr> <tr> <td>IPv6 -in-IPv4 (RFC4213)</td> <td>IPv4 tunnels that carry IPv6</td> </tr> <tr> <td>IPv6 over IPv4</td> <td>IPv6 over IPv4 tunnel</td> </tr> <tr> <td>GRE</td> <td>Generic Routing Encapsulation</td> </tr> <tr> <td>IOT</td> <td></td> </tr> <tr> <td>L2</td> <td>Layer 2 Tunnelling Protocol</td> </tr> <tr> <td>PPP</td> <td>Point to Point Protocol</td> </tr> <tr> <td>PPPoE</td> <td>Point to Point Protocol over Ethernet</td> </tr> <tr> <td>PPPoATM</td> <td>Point to Point Protocol over ATM</td> </tr> <tr> <td>LTE/UMTS/GPRS/EV-DO</td> <td>CDMA, UMTS or GPRS connection using an AT-style 3G modem</td> </tr> </tbody> </table>	Option	Description	Static	Static configuration with fixed address and netmask.	DHCP Client	Address and netmask are assigned by DHCP.	Unmanaged	Unspecified	IPv6 -in-IPv4 (RFC4213)	IPv4 tunnels that carry IPv6	IPv6 over IPv4	IPv6 over IPv4 tunnel	GRE	Generic Routing Encapsulation	IOT		L2	Layer 2 Tunnelling Protocol	PPP	Point to Point Protocol	PPPoE	Point to Point Protocol over Ethernet	PPPoATM	Point to Point Protocol over ATM	LTE/UMTS/GPRS/EV-DO	CDMA, UMTS or GPRS connection using an AT-style 3G modem
Option	Description																										
Static	Static configuration with fixed address and netmask.																										
DHCP Client	Address and netmask are assigned by DHCP.																										
Unmanaged	Unspecified																										
IPv6 -in-IPv4 (RFC4213)	IPv4 tunnels that carry IPv6																										
IPv6 over IPv4	IPv6 over IPv4 tunnel																										
GRE	Generic Routing Encapsulation																										
IOT																											
L2	Layer 2 Tunnelling Protocol																										
PPP	Point to Point Protocol																										
PPPoE	Point to Point Protocol over Ethernet																										
PPPoATM	Point to Point Protocol over ATM																										
LTE/UMTS/GPRS/EV-DO	CDMA, UMTS or GPRS connection using an AT-style 3G modem																										
<p>Web: Create a bridge over multiple interfaces</p> <p>UCI: network[.x.].type</p> <p>Opt: type</p>	<p>Enables bridge between two interfaces.</p> <table border="1"> <tbody> <tr> <td>0</td> <td>Disabled</td> </tr> <tr> <td>1</td> <td>Enabled</td> </tr> </tbody> </table>	0	Disabled	1	Enabled																						
0	Disabled																										
1	Enabled																										
<p>Web: Cover the following interface</p> <p>UCI:</p> <p>Opt: ifname</p>	<p>Selects interfaces for bridge connection.</p>																										

Click **Submit**. The Common Configuration page appears.

Common Configuration

General Setup **Advanced Settings** Physical Settings Firewall Settings

Status  3g-3g_s2_voda RX: 0.00 B (0 Pkts.) TX: 0.00 B (0 Pkts.)

Protocol

Service Type

SIM

APN

PIN

PAP/CHAP username

PAP/CHAP password 

The common configuration page

Web Field/UCI/Package Option	Description																										
Web: Protocol UCI: network[.x.].proto Opt: proto	Protocol type. Select LTE/UMTS/GPRS/EV-DO. <table border="1"> <thead> <tr> <th>Option</th> <th>Description</th> </tr> </thead> <tbody> <tr> <td>Static</td> <td>Static configuration with fixed address and netmask.</td> </tr> <tr> <td>DHCP Client</td> <td>Address and netmask are assigned by DHCP.</td> </tr> <tr> <td>Unmanaged</td> <td>Unspecified</td> </tr> <tr> <td>IPv6 -in-IPv4 (RFC4213)</td> <td>IPv4 tunnels that carry IPv6</td> </tr> <tr> <td>IPv6 over IPv4</td> <td>IPv6 over IPv4 tunnel</td> </tr> <tr> <td>GRE</td> <td>Generic Routing Encapsulation</td> </tr> <tr> <td>IOT</td> <td></td> </tr> <tr> <td>L2TP</td> <td>Layer 2 Tunnelling Protocol</td> </tr> <tr> <td>PPP</td> <td>Point to Point Protocol</td> </tr> <tr> <td>PPPoE</td> <td>Point to Point Protocol over Ethernet</td> </tr> <tr> <td>PPPoATM</td> <td>Point to Point Protocol over ATM</td> </tr> <tr> <td>LTE/UMTS/GPRS/EV-DO</td> <td>CDMA, UMTS or GPRS connection using an AT-style 3G modem</td> </tr> </tbody> </table>	Option	Description	Static	Static configuration with fixed address and netmask.	DHCP Client	Address and netmask are assigned by DHCP.	Unmanaged	Unspecified	IPv6 -in-IPv4 (RFC4213)	IPv4 tunnels that carry IPv6	IPv6 over IPv4	IPv6 over IPv4 tunnel	GRE	Generic Routing Encapsulation	IOT		L2TP	Layer 2 Tunnelling Protocol	PPP	Point to Point Protocol	PPPoE	Point to Point Protocol over Ethernet	PPPoATM	Point to Point Protocol over ATM	LTE/UMTS/GPRS/EV-DO	CDMA, UMTS or GPRS connection using an AT-style 3G modem
Option	Description																										
Static	Static configuration with fixed address and netmask.																										
DHCP Client	Address and netmask are assigned by DHCP.																										
Unmanaged	Unspecified																										
IPv6 -in-IPv4 (RFC4213)	IPv4 tunnels that carry IPv6																										
IPv6 over IPv4	IPv6 over IPv4 tunnel																										
GRE	Generic Routing Encapsulation																										
IOT																											
L2TP	Layer 2 Tunnelling Protocol																										
PPP	Point to Point Protocol																										
PPPoE	Point to Point Protocol over Ethernet																										
PPPoATM	Point to Point Protocol over ATM																										
LTE/UMTS/GPRS/EV-DO	CDMA, UMTS or GPRS connection using an AT-style 3G modem																										
Web: Service Type UCI: network[.x.].service Opt: service	Service type that will be used to connect to the network. <table border="1"> <tbody> <tr> <td>gprs_only</td> <td>Allows GSM module to only connect to GPRS network.</td> </tr> <tr> <td>lte_only</td> <td>Allows GSM module to only connect to LTE network.</td> </tr> <tr> <td>cdma</td> <td>Allows GSM module to only connect to CDMA network.</td> </tr> <tr> <td>auto</td> <td>GSM module will automatically detect the best available technology code.</td> </tr> </tbody> </table>	gprs_only	Allows GSM module to only connect to GPRS network.	lte_only	Allows GSM module to only connect to LTE network.	cdma	Allows GSM module to only connect to CDMA network.	auto	GSM module will automatically detect the best available technology code.																		
gprs_only	Allows GSM module to only connect to GPRS network.																										
lte_only	Allows GSM module to only connect to LTE network.																										
cdma	Allows GSM module to only connect to CDMA network.																										
auto	GSM module will automatically detect the best available technology code.																										
Web: SIM UCI: network[.x.].sim Opt: sim	Select SIM1 or SIM2. <table border="1"> <tbody> <tr> <td>auto</td> <td>Automatically detects which SIM slot is used.</td> </tr> <tr> <td>SIM 1</td> <td>Selects SIM from slot 1</td> </tr> <tr> <td>SIM 2</td> <td>Selects SIM from slot 2</td> </tr> </tbody> </table>	auto	Automatically detects which SIM slot is used.	SIM 1	Selects SIM from slot 1	SIM 2	Selects SIM from slot 2																				
auto	Automatically detects which SIM slot is used.																										
SIM 1	Selects SIM from slot 1																										
SIM 2	Selects SIM from slot 2																										
Web: APN UCI: network[.x.].apn Opt: apn	APN name of Mobile Network Operator.																										
Web: APN username UCI: network[.x.].username Opt: username	Username used to connect to APN.																										
Web: APN password UCI: network[.x.].password Opt: password	Password used to connect to APN.																										
Web: Modem Configuration UCI: N/A Opt: N/A	Click the link if you need to configure additional options from Mobile Manager.																										

Click **Save & Apply**.

Set Multi-WAN Options For Primary Predefined Interface

On the web interface go to **Network -> Multi-Wan**. The Multi-WAN page appears.

Multi-WAN
Multi-WAN allows for the use of multiple uplinks for failover.

WAN Interfaces
Health Monitor detects and corrects network changes and failed connections.
This section contains no values yet

The Multi-WAN page

In the WAN Interfaces section, type in the name of the Multi-WAN interface. Click **Add**. The Multi-WAN page appears.

Multi-WAN

Multi-WAN allows for the use of multiple uplinks for failover.

Enable

Preempt

Alternate Mode ⓘ It will use alternate interface after reboot

Delete

WAN Interfaces

Health Monitor detects and corrects network changes and failed connections.

Delete

3G_S1_VODA

Health Monitor Interval 10 sec.

Health Monitor ICMP Host(s) DNS Server(s)

Health Monitor ICMP Timeout 3 sec.

Attempts Before WAN Failover 3

Attempts Before WAN Recovery 5

Priority 0 ⓘ Higher value is higher priority

Manage Interface State (Up/Down)

Exclusive Group 0 ⓘ Only one interface in group could be up in the same time

Minimum ifup Interval 300 sec. ⓘ Minimum interval between two successive interface start attempts

Interface Start Timeout 40 sec. ⓘ Time for interface to startup

Signal Threshold (dBm) -115 ⓘ Below is a failure

Add

Save & Apply

Save

Reset

The Multi-WAN page

Web Field/UCI/Package Option	Description								
Web: Enable UCI: multiwan.config.enabled Opt: enabled	Enables multiwan. <table border="1"> <tr> <td>0</td> <td>Disabled</td> </tr> <tr> <td>1</td> <td>Enabled</td> </tr> </table>	0	Disabled	1	Enabled				
0	Disabled								
1	Enabled								
Web: Preempt UCI: multiwan.config.preempt Opt: preempt	Enables or disables pre-emption for multiwan. If enabled, the router will keep trying to connect to a higher priority interface depending on timer set. <table border="1"> <tr> <td>0</td> <td>Disabled</td> </tr> <tr> <td>1</td> <td>Enabled</td> </tr> </table>	0	Disabled	1	Enabled				
0	Disabled								
1	Enabled								
Web: Alternate Mode UCI: multiwan.config.alt Opt: alt	Enables or disables alternate mode for multiwan. If enabled, the router will use an alternate interface after reboot. <table border="1"> <tr> <td>0</td> <td>Disabled</td> </tr> <tr> <td>1</td> <td>Enabled</td> </tr> </table>	0	Disabled	1	Enabled				
0	Disabled								
1	Enabled								
Web: WAN Interfaces UCI: multiwan.3g_s<sim-number>_<short-operator-name> Opt: 3g_s<sim-number>_<short-operator-name>	Provide the same interface name as chosen in multiwan section below and click Add .								
Web: Health Monitor Interval UCI: multiwan[.x.].health_interval Opt: health_interval	Sets the period to check the health status of the interface. The Health Monitor interval will be used for: <ul style="list-style-type: none"> Interface state checks Ping interval Signal strength checks 								
Web: Health Monitor ICMP Host(s) UCI: multiwan[.x.].icmp_hosts Opt: icmp_hosts	Specifies the target IP address for ICMP packets. <table border="1"> <tr> <td>Disable</td> <td>Disables the option</td> </tr> <tr> <td>DNS servers</td> <td>DNS IP addresses will be used.</td> </tr> <tr> <td>WAN Gateway</td> <td>Gateway IP address will be used.</td> </tr> <tr> <td>Custom</td> <td>Ability to provide IP address.</td> </tr> </table>	Disable	Disables the option	DNS servers	DNS IP addresses will be used.	WAN Gateway	Gateway IP address will be used.	Custom	Ability to provide IP address.
Disable	Disables the option								
DNS servers	DNS IP addresses will be used.								
WAN Gateway	Gateway IP address will be used.								
Custom	Ability to provide IP address.								
Web: Health Monitor Contrack Test Host(s) UCI: multiwan.wan.contrack_hosts Opt: contrack_hosts	Contrack is the feature used to track if there is any traffic to and from an IP destination within the health interval. Contrack_hosts option defines the IP for contrack to track – usually the icmp_host IP is used. If traffic to the contrack_hosts IP is detected then multiwan does not send a ping health check to the icmp_host otherwise a ping is sent as normal to the icmp_host. By default the contrack_hosts is checked if the health interval is greater than 5 minutes. This time threshold currently cannot be manipulated. Contrack is generally used to limit the traffic sent on a GSM network. <table border="1"> <tr> <td>Default</td> <td>Contrack checks for traffic from icmp_host IP when health_interval is greater than 5 minutes.</td> </tr> <tr> <td>Disable</td> <td>Contrack is Disabled.</td> </tr> <tr> <td>Custom</td> <td>Specifies an IP other than the icmp_host for contrack to track.</td> </tr> </table>	Default	Contrack checks for traffic from icmp_host IP when health_interval is greater than 5 minutes.	Disable	Contrack is Disabled.	Custom	Specifies an IP other than the icmp_host for contrack to track.		
Default	Contrack checks for traffic from icmp_host IP when health_interval is greater than 5 minutes.								
Disable	Contrack is Disabled.								
Custom	Specifies an IP other than the icmp_host for contrack to track.								
Web: Health Monitor ICMP Timeout UCI: multiwan[.x.].timeout Opt: timeout	Sets ping timeout in seconds. Choose the time in seconds that the health monitor ICMP will timeout at. <table border="1"> <tr> <td>3</td> <td>Wait 3 seconds for ping reply.</td> </tr> <tr> <td>Range</td> <td></td> </tr> </table>	3	Wait 3 seconds for ping reply.	Range					
3	Wait 3 seconds for ping reply.								
Range									

Web Field/UCI/Package Option	Description				
Web: Health Monitor ICMP Interval UCI: multiwan.wan.icmp_interval Opt: icmp_interval	Defines the interval between multiple pings sent at each health check. <table border="1"> <tr><td>1</td><td></td></tr> <tr><td>Range</td><td></td></tr> </table>	1		Range	
1					
Range					
Web: Health Monitor ICMP Count UCI: multiwan.wan.icmp_count Opt: icmp_count	Defines the number of pings to send at each health check. <table border="1"> <tr><td>1</td><td></td></tr> <tr><td>Range</td><td>Enabled</td></tr> </table>	1		Range	Enabled
1					
Range	Enabled				
Web: Attempts Before WAN Failover UCI: multiwan.[..x..].health_fail_retries Opt: health_fail_retries	Sets the amount of health monitor retries before the interface is considered a failure. <table border="1"> <tr><td>3</td><td></td></tr> <tr><td>Range</td><td></td></tr> </table>	3		Range	
3					
Range					
Web: Attempts Before WAN Recovery UCI: multiwan.[..x..].health_recovery_retries Opt: health_recovery_retries	Sets the number of health monitor checks before the interface is considered healthy. Only relevant if pre-empt mode is enabled. <table border="1"> <tr><td>5</td><td></td></tr> <tr><td>Range</td><td></td></tr> </table>	5		Range	
5					
Range					
Web: Priority UCI: multiwan.[..x..].priority Opt: priority	Specifies the priority of the interface. The higher the value, the higher the priority. This multiwan interface priority must be higher than the one specified in the priority field in the 'Roaming Interface Template' page described in the following section. <table border="1"> <tr><td>0</td><td></td></tr> <tr><td>Range</td><td></td></tr> </table>	0		Range	
0					
Range					
Web: Exclusive Group UCI: multiwan.[..x..].exclusive_group Opt: exclusive_group	Defines the group to which the interface belongs; only one interface can be active. <table border="1"> <tr><td>0</td><td></td></tr> <tr><td>Range</td><td></td></tr> </table>	0		Range	
0					
Range					
Web: Manage Interface State (Up/Down) UCI: multiwan.[..x..].manage_state Opt: manage_state	Defines whether multiwan will start and stop the interface. Select Enabled . <table border="1"> <tr><td>0</td><td>Disabled</td></tr> <tr><td>1</td><td>Enabled</td></tr> </table>	0	Disabled	1	Enabled
0	Disabled				
1	Enabled				
Web: Minimum ifup Interval UCI: multiwan.[..x..].ifup_retry_sec Opt: ifup_retry_sec	Specifies the interval in seconds before retrying the primary interface when pre-empt mode is enabled.				
Web: Interface Start Timeout UCI: multiwan.[..x..].ifup_timeout Opt: ifup_timeout	Specifies the time in seconds for interface to start up. If it is not up after this period, it will be considered a fail. Choose timer greater than 120 seconds. <table border="1"> <tr><td>40</td><td>40 Seconds</td></tr> <tr><td>Range</td><td></td></tr> </table>	40	40 Seconds	Range	
40	40 Seconds				
Range					
Web: Signal Threshold (dBm) UCI: multiwan.[..x..].signal_threshold Opt: signal_threshold	Specifies the minimum signal strength in dBm before considering if the interface fails signal health check. Uses the value stored for sig_dbm in mobile diagnostics. <table border="1"> <tr><td>-115</td><td>Disabled</td></tr> <tr><td>Range</td><td>-46 to -115dBm</td></tr> </table>	-115	Disabled	Range	-46 to -115dBm
-115	Disabled				
Range	-46 to -115dBm				
Web: RSCP Threshold (dBm) UCI: multiwan.[..x..].rscp_threshold	Specifies the minimum RSCP signal strength in dBm before considering if the interface fails signal health check. Uses the value stored for rscp_dbm in mobile diagnostics.				

Web Field/UCI/Package Option	Description																
Opt: rscp_threshold																	
Web: ECIO Threshold (dB) UCI: multiwan,[..x..].ecio_threshold Opt: ecio_threshold	Specifies the minimum ECIO signal strength in dB before considering if the interface fails signal health check. Uses the value stored for ecio_db in mobile diagnostics.																
Web: Signal Test UCI: multiwan,[..x..].signal_test Opt: signal_test	<p>Defines script to test various signal characteristics in multiwan signal test. For example:</p> <pre>option signal_test '(tech == 0) then (sig_dbm > -70) else (rscp_dbm > -105 and ecio_db > -15)'</pre> <p>This states that when technology is GSM a health fail is determined when signal strength is less than -70dBm. When technology is not GSM a health fail occurs when either rscp_dbm falls below -105dBm or ecio_db falls below -15dB.</p> <p>Tech values are:</p> <table border="1"> <tbody> <tr><td>0</td><td>GSM</td></tr> <tr><td>1</td><td>GSM Compact</td></tr> <tr><td>2</td><td>UTRAN</td></tr> <tr><td>3</td><td>GSM w/EGPRS</td></tr> <tr><td>4</td><td>UTRAN w/HSPDA</td></tr> <tr><td>5</td><td>UTRAN w/HSUPA</td></tr> <tr><td>6</td><td>UTRAN w/HSUPA and HSDPA</td></tr> <tr><td>7</td><td>E-UTRAN</td></tr> </tbody> </table>	0	GSM	1	GSM Compact	2	UTRAN	3	GSM w/EGPRS	4	UTRAN w/HSPDA	5	UTRAN w/HSUPA	6	UTRAN w/HSUPA and HSDPA	7	E-UTRAN
0	GSM																
1	GSM Compact																
2	UTRAN																
3	GSM w/EGPRS																
4	UTRAN w/HSPDA																
5	UTRAN w/HSUPA																
6	UTRAN w/HSUPA and HSDPA																
7	E-UTRAN																

Click **Save**.

Set Options For Automatically Created Interfaces (Failover)

In the top menu on the web interface page, select **Services -> Mobile Manager**. The Mobile Manager page appears.

There are five sections in the mobile manager page:

Section	Description
Basic settings	Enable SMS, configure SIM pin code, select roaming SIM, collect ICCIDs and set IMSI.
Advanced	Configure advanced options such as collect ICCIDs and temperature polling interval.
CDMA*	CDMA configuration
Callers	Configure callers that can use SMS.
Roaming Interface Template	Configure Preferred Roaming List options.
*Option available only for Telit CE910-SL module.	

24.2. Mobile Manager: Basic Settings

MAIN

Basic **Advanced** CDMA

SMS Enable

PIN-code for SIM1

PIN-code for SIM2

LTE Bands for SIM1

LTE Bands for SIM2

The mobile manager basic page

Web Field/UCI/Package Option	Description				
Web: SMS Enable UCI: mobile.main.sms Opt: sms	Enables or disables SMS functionality. <table border="1"> <tr> <td>0</td> <td>Disabled</td> </tr> <tr> <td>1</td> <td>Enabled</td> </tr> </table>	0	Disabled	1	Enabled
0	Disabled				
1	Enabled				
Web: PIN code for SIM1 UCI: mobile.main.sim1pin Opt: sim1pin	Depending on the SIM card specifies the pin code for SIM 1. <table border="1"> <tr> <td>Blank</td> <td>Disabled</td> </tr> <tr> <td>Range</td> <td>Depends on the SIM provider</td> </tr> </table>	Blank	Disabled	Range	Depends on the SIM provider
Blank	Disabled				
Range	Depends on the SIM provider				
Web: PIN code for SIM2 UCI: mobile.main.sim2pin Opt: sim2pin	Depending on the SIM card specify the pin code for SIM 2. <table border="1"> <tr> <td>Blank</td> <td></td> </tr> <tr> <td>Range</td> <td>Depends on the SIM provider</td> </tr> </table>	Blank		Range	Depends on the SIM provider
Blank					
Range	Depends on the SIM provider				
Web: LTE bands for SIM1 UCI: mobile.main.sim1_lte_bands Opt: sim1_lte_bands	Depending on the SIM card specify the LTE bands for SIM 1. Comma delimiter. Example: option sim1_lte_bands '3,20' Limits LTE bands to 3 and 20. Note: currently only supported by Hucom/Wetelcom, SIMCom7100, Cellient MPL200 and Asiatel.				
Web: LTE bands for SIM2 UCI: mobile.main.sim2_lte_bands Opt:sim2_lte_bands	Depending on the SIM card specifies the LTE bands for SIM 2. Comma delimiter. Example: option sim1_lte_bands '3,20' Limits LTE bands to 3 and 20. Note: currently only supported by Hucom/Wetelcom, SIMCom7100, Cellient MPL200 and Asiatel.				

24.3. Mobile Manager: Advanced Settings

MAIN

Basic **Advanced** CDMA

Collect ICCIDs [?](#) *Collect ICCIDs on startup*

Force Mode [?](#) *Select network interface mode*

Temperature Polling Interval (Seconds)

Automatic Firmware Selection [?](#) *Select firmware based on network operator - only supported on some radio modules*

Allow USB Power Cycle [?](#) *Power cycle usb bus if modem disappeared from the USB bus for more then 40 seconds*

The mobile manager advanced page

Web Field/UCI/Package Option	Description				
Web: Collect ICCIDs UCI: mobile.main.init_get_iccids Opt: init_get_iccids	Enables or disables integrated circuit card identifier ICCID's collection functionality. If enabled then both SIM 1 and SIM 2 ICCIDs will be collected otherwise it will default to SIM 1. This will be displayed under mobile stats. <table border="1"> <tr> <td>0</td> <td>Disabled</td> </tr> <tr> <td>1</td> <td>Enabled</td> </tr> </table>	0	Disabled	1	Enabled
0	Disabled				
1	Enabled				
Web: Force Mode UCI: mobile.main.force_mode Opt: force_mode	Defines whether to operate mobile modem in PPP or Ethernet mode. The mode will be dependent on the service provided by the mobile provider. In general, this is Ethernet mode (default). <table border="1"> <tr> <td>Automatic</td> <td>Ethernet mode (option not present)</td> </tr> <tr> <td>PPP</td> <td>Enable PPP mode</td> </tr> </table>	Automatic	Ethernet mode (option not present)	PPP	Enable PPP mode
Automatic	Ethernet mode (option not present)				
PPP	Enable PPP mode				
Web: Temperature Polling Interval UCI: mobile.main.temp_poll_interval_sec Opt: temp_poll_interval_sec	Defines the time in seconds to poll the mobile module for temperature. Set to 0 to disable. <table border="1"> <tr> <td>61</td> <td>61 seconds</td> </tr> <tr> <td>1</td> <td>Enabled</td> </tr> </table>	61	61 seconds	1	Enabled
61	61 seconds				
1	Enabled				
Web: Automatic Firmware Selection UCI: mobile.main.enable_firmware_autoselect Opt: enable_firmware_autoselect	Defines whether to use time obtained from the mobile carrier to update the system clock when NTP is enabled. <table border="1"> <tr> <td>0</td> <td>Disabled</td> </tr> <tr> <td>1</td> <td>Enabled</td> </tr> </table>	0	Disabled	1	Enabled
0	Disabled				
1	Enabled				
Web: Allow USB Power Cycle UCI: mobile.main.allow_usb_powercycle Opt: allow_usb_powercycle	Enables the selection of an operator-specific firmware in the radio module. The selection is based on the ICCID of the used SIM. At module initialisation the IMSI is checked and if necessary the correct firmware image in the module will be activated. <p>Note: activation of the firmware will lead to delayed startup of the network interface associated with the radio module.</p> <p>Note: this feature is currently only supported for the Telit LE910NA V2 module. Here a Verizon-specific firmware will be selected if the ICCID starts with "891480".</p> <table border="1"> <tr> <td>0</td> <td>Disabled</td> </tr> <tr> <td>1</td> <td>Enabled</td> </tr> </table>	0	Disabled	1	Enabled
0	Disabled				
1	Enabled				
Web: n/a UCI: mobile.main.disable_time Opt: disable_time	Defines whether to use time obtained from the mobile carrier to update the system clock when NTP is enabled. <table border="1"> <tr> <td>0</td> <td>Disabled</td> </tr> <tr> <td>1</td> <td>Enabled</td> </tr> </table>	0	Disabled	1	Enabled
0	Disabled				
1	Enabled				

24.4. Mobile Manager: CDMA Settings

This configuration page is only supported for the Telit CE910-SL CDMA module.

MAIN

Basic

Advanced

CDMA

IMSI ⓘ *If specified over-writes IMSI stored in radio module*

HDR Auth User ID ⓘ *AN-PPP user id. Supported on Cellient module only*

HDR Auth Password ⓘ *AN-PPP password. Supported on Cellient module only*

Ordered Registration
triggers module
reboot

Station Class Mark

Slot Cycle Index

Slot Mode

Mobile Directory
Number

MOB_TERM_HOME
registration flag

MOB_TERM_FOR_SID
registration flag

MOB_TERM_FOR_NID

The mobile manager CDMA page

Web Field/UCI/Package Option	Description				
Web: IMSI UCI: mobile.main.imsi Opt: imsi	Allows the IMSI (International Mobile Subscriber Identity) to be changed. <table border="1"> <tr> <td>Default</td> <td>Programmed in module.</td> </tr> <tr> <td>Digits</td> <td>Up to 15 digits</td> </tr> </table>	Default	Programmed in module.	Digits	Up to 15 digits
Default	Programmed in module.				
Digits	Up to 15 digits				
Web: HDR Auth User ID UCI: mobile.main.hdr_userid Opt: hdr_userid	AN-PPP user ID. Supported on Cellient (CDMA) modem only. <table border="1"> <tr> <td>Blank</td> <td></td> </tr> <tr> <td>Range</td> <td>Depends on the CDMA provider.</td> </tr> </table>	Blank		Range	Depends on the CDMA provider.
Blank					
Range	Depends on the CDMA provider.				
Web: HDR Auth User Password UCI: mobile.main.hdr_password Opt: hdr_password	AN-PPP password. Supported on Cellient (CDMA) modem only. <table border="1"> <tr> <td>Blank</td> <td></td> </tr> <tr> <td>Range</td> <td>Depends on the CDMA provider.</td> </tr> </table>	Blank		Range	Depends on the CDMA provider.
Blank					
Range	Depends on the CDMA provider.				
Web: Ordered Registration triggers module reboot UCI: mobile.main. mobile.main.cdma_ordered_registration_reboot_enabled Opt: cdma_ordered_registration_reboot_enabled	Enables or disables rebooting the module after an Order Registration command is received from a network. <table border="1"> <tr> <td>0</td> <td>Disabled</td> </tr> <tr> <td>1</td> <td>Enabled</td> </tr> </table>	0	Disabled	1	Enabled
0	Disabled				
1	Enabled				
Web: Station Class Mark UCI: mobile.main.cdma_station_class_mark Opt: cdma_station_class_mark	Allows the station class mark for the MS to be changed. <table border="1"> <tr> <td>Default</td> <td>58</td> </tr> <tr> <td>Range</td> <td>0-255</td> </tr> </table>	Default	58	Range	0-255
Default	58				
Range	0-255				
Web: Slot Cycle Index UCI: mobile.main.cdma_slot_cycle_index Opt: cdma_slot_cycle_index	The desired slot cycle index if different from the default. <table border="1"> <tr> <td>Default</td> <td>2</td> </tr> <tr> <td>Range</td> <td>0-7</td> </tr> </table>	Default	2	Range	0-7
Default	2				
Range	0-7				
Web: Slot Mode UCI: mobile.main.cdma_slot_mode Opt: cdma_slot_mode	Specifies the slot mode. <table border="1"> <tr> <td>Default</td> <td>0</td> </tr> <tr> <td>Range</td> <td>0-7</td> </tr> </table>	Default	0	Range	0-7
Default	0				
Range	0-7				
Web: Mobile Directory Number UCI: mobile.main.cdma_mobile_directory_number Opt: cdma_mobile_directory_number	Allows the mobile directory number (MDN) to be changed.				
Web: MOB_TERM_HOME registration flag UCI: mobile.main. cdma_mob_term_home_registration_flag Opt: cdma_mob_term_home_registration_flag	The MOB_TERM_HOME registration flag. <table border="1"> <tr> <td>Default</td> <td>Programmed in module.</td> </tr> <tr> <td>Digits</td> <td>Up to 15 digits.</td> </tr> </table>	Default	Programmed in module.	Digits	Up to 15 digits.
Default	Programmed in module.				
Digits	Up to 15 digits.				
Web: MOB_TERM_FOR_SID registration flag UCI: mobile.main. cdma_mob_term_for_sid_registration_flag Opt: cdma_mob_term_for_sid_registration_flag	The MOB_TERM_FOR_SID registration flag. <table border="1"> <tr> <td>0</td> <td>Disabled</td> </tr> <tr> <td>1</td> <td>Enabled</td> </tr> </table>	0	Disabled	1	Enabled
0	Disabled				
1	Enabled				
Web: MOB_TERM_FOR_NID registration flag UCI: mobile.main. cdma_mob_term_for_nid_registration_flag Opt: cdma_mob_term_for_nid_registration_flag	The MOB_TERM_FOR_NID registration flag. <table border="1"> <tr> <td>0</td> <td>Disabled</td> </tr> <tr> <td>1</td> <td>Enabled</td> </tr> </table>	0	Disabled	1	Enabled
0	Disabled				
1	Enabled				
Web: Access Overload Control UCI: mobile.main.cdma_access_overload_control Opt: cdma_access_overload_control	Allows the access overload class to be changed. <table border="1"> <tr> <td>Default</td> <td>Programmed into module as part of IMSI.</td> </tr> <tr> <td>Range</td> <td>0-7</td> </tr> </table>	Default	Programmed into module as part of IMSI.	Range	0-7
Default	Programmed into module as part of IMSI.				
Range	0-7				

Web Field/UCI/Package Option	Description				
Web: Preferred Serving System UCI: mobile.main.cdma_preferred_serving_system Opt: cdma_preferred_serving_system	The CDMA Preferred Serving System(A/B). <table border="1"> <tr> <td>Default</td> <td>5</td> </tr> <tr> <td>Range</td> <td>0-7</td> </tr> </table>	Default	5	Range	0-7
Default	5				
Range	0-7				
Web: Digital Analog Mode Preference UCI: cdma_digital_analog_mode_preference Opt: cdma_digital_analog_mode_preference	Digital/Analog Mode Preference. <table border="1"> <tr> <td>Default</td> <td>4</td> </tr> <tr> <td>Range</td> <td></td> </tr> </table>	Default	4	Range	
Default	4				
Range					
Web: Primary Channel A UCI: mobile.main.cdma_primary_channel_a Opt: cdma_primary_channel_a.	Allows the primary channel (A) to be changed. <table border="1"> <tr> <td>Default</td> <td>283</td> </tr> <tr> <td>Range</td> <td>1-2016 Any band class 5 channel number</td> </tr> </table>	Default	283	Range	1-2016 Any band class 5 channel number
Default	283				
Range	1-2016 Any band class 5 channel number				
Web: Primary Channel B UCI: mobile.main.cdma_primary_channel_b Opt: cdma_primary_channel_b	Allows the primary channel (B) to be changed. <table border="1"> <tr> <td>Default</td> <td>384</td> </tr> <tr> <td>Range</td> <td>1-2016 Any band class 5 channel number</td> </tr> </table>	Default	384	Range	1-2016 Any band class 5 channel number
Default	384				
Range	1-2016 Any band class 5 channel number				
Web: Secondary Channel A UCI: mobile.main.cdma_secondary_channel_a Opt: cdma_secondary_channel_a	Allows the secondary channel (A) to be changed. <table border="1"> <tr> <td>Default</td> <td>691</td> </tr> <tr> <td>Range</td> <td>1-2016 Any band class 5 channel number</td> </tr> </table>	Default	691	Range	1-2016 Any band class 5 channel number
Default	691				
Range	1-2016 Any band class 5 channel number				
Web: Secondary Channel B UCI: mobile.main.cdma_secondary_channel_b Opt: cdma_secondary_channel_b	Allows the secondary channel (B) to be changed. <table border="1"> <tr> <td>Default</td> <td>777</td> </tr> <tr> <td>Range</td> <td>1-2016 Any band class 5 channel number</td> </tr> </table>	Default	777	Range	1-2016 Any band class 5 channel number
Default	777				
Range	1-2016 Any band class 5 channel number				
Web: Preferred Forward & Reverse RC UCI: mobile.main.cdma_preferred_forward_and_re verse_rc Opt: cdma_preferred_forward_and_reverse_rc	The Preferred Forward & Reverse RC value, this takes the form "forward_rc,reverse_rc" Format: forward radio channel, reverse radio channel Default: 0,0				
Web: SID-NID pairs UCI: mobile.main.cdma_sid_nid_pairs Opt: cdma_sid_nid_pairs	Allows specification of SID:NID pairs, this takes the form "SID1,NID1,SID2,NID2, #" <table border="1"> <tr> <td>Format</td> <td>SID1 (0-65535),NID (0-65535)</td> </tr> <tr> <td>Default</td> <td>0,65535</td> </tr> </table>	Format	SID1 (0-65535),NID (0-65535)	Default	0,65535
Format	SID1 (0-65535),NID (0-65535)				
Default	0,65535				

24.5. Mobile Manager: Callers

Callers

Configure caller numbers that may use the SMS service.

Name ⓘ Name of the caller.

Number ⓘ Number of the caller. Use * for wildcard matching.

Enable

Respond

The mobile manager CDMA page

Web Field/UCI/Package Option	Description						
Web: Name UCI: mobile.@caller[0].name Opt: name	Name assigned to the caller. <table border="1" data-bbox="555 297 722 365"> <tr> <td>Default</td> <td>Blank</td> </tr> <tr> <td>Range</td> <td>No limit</td> </tr> </table>	Default	Blank	Range	No limit		
Default	Blank						
Range	No limit						
Web: Number UCI: mobile.@caller[0].number Opt: number	Number of the caller allowed to SMS the router. Add in specific caller numbers, or use the * wildcard symbol. <table border="1" data-bbox="555 461 946 607"> <tr> <td>Default</td> <td>Blank</td> </tr> <tr> <td>Range</td> <td>No limit</td> </tr> <tr> <td>Characters</td> <td>Global value (*) is accepted. International value (+) is accepted</td> </tr> </table>	Default	Blank	Range	No limit	Characters	Global value (*) is accepted. International value (+) is accepted
Default	Blank						
Range	No limit						
Characters	Global value (*) is accepted. International value (+) is accepted						
Web: Enable UCI: mobile.@caller[0].enabled Opt: enabled	Enables or disables incoming caller ID. <table border="1" data-bbox="555 680 679 748"> <tr> <td>0</td> <td>Disabled</td> </tr> <tr> <td>1</td> <td>Enabled</td> </tr> </table>	0	Disabled	1	Enabled		
0	Disabled						
1	Enabled						
Web: Respond UCI: mobile.@caller[0].respond Opt: respond	If checked, the router will return an SMS. Select Respond if you want the router to reply. <table border="1" data-bbox="555 822 679 889"> <tr> <td>0</td> <td>Disabled</td> </tr> <tr> <td>1</td> <td>Enabled</td> </tr> </table>	0	Disabled	1	Enabled		
0	Disabled						
1	Enabled						

24.6. Roaming Interface Template: Web Interface

Roaming Interface Template

Common config values for interfaces created by Automatic Operator Selection

Interface Signal Sort *Sort interfaces by signal strength so those having better signal strength at the startup would be tried first*

Roaming SIM *In which slot roaming sim-card is inserted*

Firewall Zone lan: lan: lan1: lan1: wlan: wlan: wlan1: wlan1:

wan: wan:

unspecified -or- create:

Append all the generated interfaces to this zone

APN

PIN

PAP/CHAP username

PAP/CHAP password

Service Preference
UMTS
GPRS
CDMA/EV-DO
Auto *Order of service preference for the generated interfaces (Use Control button to select multiple)*

Health Monitor Interval

Health Monitor ICMP Host(s)

Health Monitor Conntrack Test Host(s)

Health Monitor ICMP Timeout

Health Monitor ICMP Interval

Attempts Before WAN Failover

Attempts Before WAN Recovery

The roaming interface template page

Web Field/UCI/Package Option	Description						
Web: Interface Signal Sort UCI: mobile.@roaming_template[0].sort_sig_strength Opt: sort_sig_strength	Sorts interfaces by signal strength priority, so those that have a better signal strength will be tried first. <table border="1"> <tr> <td>0</td> <td>Disabled</td> </tr> <tr> <td>1</td> <td>Enabled</td> </tr> </table>	0	Disabled	1	Enabled		
0	Disabled						
1	Enabled						
Web: Roaming SIM UCI: mobile.main.roaming_sim Opt: roaming_sim	Sets in which slot to insert roaming SIM card. <table border="1"> <tr> <td>1</td> <td>SIM slot 1</td> </tr> <tr> <td>2</td> <td>SIM slot 2</td> </tr> </table>	1	SIM slot 1	2	SIM slot 2		
1	SIM slot 1						
2	SIM slot 2						
Web: Firewall Zone UCI: mobile.@roaming_template[0].firewall_zone Opt: firewall_zone	Adds all generated interfaces to this zone. Select existing zone or click unspecified or create to create new zone.						
Web: APN UCI: mobile.@roaming_template[0].apn Opt: apn	APN name of Mobile Network Operator.						
Web: PIN UCI: mobile.@roaming_template[0].pincode Opt: pincode	SIM card's PIN number.						
Web: PAP/CHAP username UCI: mobile.@roaming_template[0].username Opt: username	Username used to connect to APN.						
Web: PAP/CHAP password UCI: mobile.@roaming_template[0].password Opt: password	Password used to connect to APN.						
Web: Service Order UCI: mobile.@roaming_template[0].service_order Opt: service_order	Defines a space separated list of services, in preferred order. Valid options are gprs, umts, lte, auto. If no valid_service order is defined, then the configured Service Type is used. Example: mobile.@roaming_template[0].service_order="gprs umts lte auto" <table border="1"> <tr> <td>Default</td> <td>Blank. Automatically detect best service.</td> </tr> <tr> <td>Range</td> <td>gprs umts lte auto</td> </tr> </table>	Default	Blank. Automatically detect best service.	Range	gprs umts lte auto		
Default	Blank. Automatically detect best service.						
Range	gprs umts lte auto						
Web: Health Monitor Interval UCI:	Sets the period, in seconds, to check the health status of the interface. The Health Monitor interval will be used for: <ul style="list-style-type: none"> • Interface state checks • Ping interval • Signal strength checks <table border="1"> <tr> <td>Default</td> <td>10. Health checks every 10 seconds.</td> </tr> <tr> <td>Range</td> <td></td> </tr> </table>	Default	10. Health checks every 10 seconds.	Range			
Default	10. Health checks every 10 seconds.						
Range							
Web: Health Monitor ICMP Host(s) UCI: mobile.@roaming_template[0].icmp_host_s	Specifies target IP address for ICMP packets. <table border="1"> <thead> <tr> <th>Web</th> <th>Description</th> <th>UCI</th> </tr> </thead> <tbody> <tr> <td></td> <td></td> <td></td> </tr> </tbody> </table>	Web	Description	UCI			
Web	Description	UCI					

Web Field/UCI/Package Option	Description														
Opt: icmp_hosts	Disable	Disables the option.	disable												
	DNS servers	DNS IP addresses will be used.	dns												
	WAN gateway	Gateway IP address will be used.	gateway												
	custom	Ability to provide IP address. Multiple pings targets can be entered, comma separated. Pings to both must fail for health check to fail. Example: option icmp_hosts '1.1.1.1,2.2.2.2'													
Web: Health Monitor Contrack Test Host(s) UCI: mobile.@roaming_template[0].contrack_hosts Opt: contrack_hosts	<p>Contrack is the feature used to track if there is any traffic to and from an IP destination within the health interval.</p> <p>The Contrack_hosts option defines the IP for contrack to track, usually the icmp_host IP is used.</p> <p>If traffic to the contrack_hosts IP is detected then multiwan does not send a ping health check to the icmp_host; otherwise a ping is sent as normal to the icmp_host.</p> <p>By default the contrack_hosts is checked if the health interval is greater than 5 minutes. This time threshold currently cannot be manipulated.</p> <p>Contrack is generally used to limit the traffic sent on a GSM network.</p> <table border="1" data-bbox="775 958 1398 1171"> <thead> <tr> <th>Web</th> <th>Description</th> <th>UCI</th> </tr> </thead> <tbody> <tr> <td>Default</td> <td>Contrack checks for traffic from icmp_host IP when health_interval is greater than 5 minutes.</td> <td></td> </tr> <tr> <td>Disable</td> <td>Contrack checks for traffic from icmp_host IP when health_interval is greater than 5 minutes.</td> <td>disable</td> </tr> <tr> <td>custom</td> <td>Specifies an IP other than the icmp_host for contrack to track.</td> <td></td> </tr> </tbody> </table>			Web	Description	UCI	Default	Contrack checks for traffic from icmp_host IP when health_interval is greater than 5 minutes.		Disable	Contrack checks for traffic from icmp_host IP when health_interval is greater than 5 minutes.	disable	custom	Specifies an IP other than the icmp_host for contrack to track.	
Web	Description	UCI													
Default	Contrack checks for traffic from icmp_host IP when health_interval is greater than 5 minutes.														
Disable	Contrack checks for traffic from icmp_host IP when health_interval is greater than 5 minutes.	disable													
custom	Specifies an IP other than the icmp_host for contrack to track.														
Web: Health Monitor ICMP Timeout UCI: mobile.@roaming_template[0].timeout Opt: timeout	<p>Specifies the time in seconds that Health Monitor ICMP will timeout at.</p> <p>Sets ping timeout in seconds. Choose the time in seconds that the health monitor ICMP will timeout at.</p> <table border="1" data-bbox="775 1346 1121 1417"> <tbody> <tr> <td>Default</td> <td>3. Wait 3 seconds for ping reply.</td> </tr> <tr> <td>Range</td> <td></td> </tr> </tbody> </table>			Default	3. Wait 3 seconds for ping reply.	Range									
Default	3. Wait 3 seconds for ping reply.														
Range															
Web: Health Monitor ICMP Interval UCI: mobile.@roaming_template[0].interval Opt: icmp_interval	<p>Defines the interval, in seconds, between multiple pings sent at each health check.</p> <table border="1" data-bbox="775 1512 887 1583"> <tbody> <tr> <td>Default</td> <td>1</td> </tr> <tr> <td>Range</td> <td></td> </tr> </tbody> </table>			Default	1	Range									
Default	1														
Range															
Web: Attempts Before WAN Failover UCI: mobile.@roaming_template[1].health_fail_retries Opt: health_fail_retries	<p>Defines the number of health check failures before interface is disconnected.</p> <table border="1" data-bbox="775 1677 887 1749"> <tbody> <tr> <td>Default</td> <td>3</td> </tr> <tr> <td>Range</td> <td></td> </tr> </tbody> </table>			Default	3	Range									
Default	3														
Range															
Web: Attempts Before WAN Recovery UCI: mobile.@roaming_template[0].health_recovery_retries Opt: health_recovery_retries	<p>Sets the number of health check passes before the interface is considered healthy. This field is not used for a roaming template.</p> <table border="1" data-bbox="775 1924 887 1984"> <tbody> <tr> <td>Default</td> <td>5</td> </tr> <tr> <td>Range</td> <td></td> </tr> </tbody> </table>			Default	5	Range									
Default	5														
Range															

Web Field/UCI/Package Option	Description				
Web: Priority UCI: mobile.@roaming_template[0].priority Opt: priority	Type the priority number. The higher the value, the higher the priority. This multi-WAN interface priority must be lower than the one specified in the priority field for the PMP interface. <table border="1"> <tr> <td>Default</td> <td>0</td> </tr> <tr> <td>Range</td> <td></td> </tr> </table>	Default	0	Range	
Default	0				
Range					
Web: Multi-WAN: Exclusive Group UCI: mobile.@roaming_template[0].multiwan_exclusive_group Opt: multiwan_exclusive_group	Specifies the Multi-WAN group for the generated roaming interfaces. Defaults to '3g' if not specified.				
Web: Minimum ifup interval UCI: multiwan.wan.ifup_retry_sec Opt: ifup_retry_sec	Not used for a roaming interface. <table border="1"> <tr> <td>Default</td> <td>300. Retry primary interface every 300 seconds.</td> </tr> <tr> <td>Range</td> <td></td> </tr> </table>	Default	300. Retry primary interface every 300 seconds.	Range	
Default	300. Retry primary interface every 300 seconds.				
Range					
Web: Interface Start Timeout UCI: mobile.@roaming_template[0].ifup_timeout_sec Opt: ifup_timeout	Specifies the time in seconds for interface to start up. If it is not up after this period, it will be considered a fail. <table border="1"> <tr> <td>Default</td> <td>40</td> </tr> <tr> <td>1</td> <td>Enabled</td> </tr> </table>	Default	40	1	Enabled
Default	40				
1	Enabled				
Web: Signal Threshold (dBm) UCI: mobile.@roaming_template[0].signal_threshold Opt: signal_threshold	Specifies the minimum RSCP signal strength in dBm before considering if the interface fails signal health check. Uses the value stored for rscp_dbm in mobile diagnostics. <table border="1"> <tr> <td>Default</td> <td>-115dBm</td> </tr> <tr> <td>Range</td> <td>-46 to -115 dBm</td> </tr> </table>	Default	-115dBm	Range	-46 to -115 dBm
Default	-115dBm				
Range	-46 to -115 dBm				

When you have configured your settings, click **Save & Apply**.

System

Reboot

Reboots the operating system of your device

Reboot now

Reboot on - - :

Powered by LuCI Trunk (trunk+svn8382) 15.00.32 image1 config2

The reboot page

In the top menu, select **System** -> **Reboot**. The System page appears.

Check the **Reboot now** check box and then click **Reboot**.

24.7. Scenario 2: PMP + Roaming: Pre-Empt Disabled

As in the previous section, Multi-WAN connects the PMP interface and uses auto-created interfaces for failover.

However, in this scenario, the auto-created interface will not be disconnected as soon as the `ifup_retry_sec` expires for the PMP interface. The primary interface will be reconnected when the current auto-created interface fails multiwan health checks after expiration of the `ifup_retry_sec` timer.

Follow the instructions in the section above for creation of the PMP interface, Multi-WAN and Mobile Manager roaming interfaces. The only change in configuration compared to the PMP + roaming: pre-empt enabled scenario is that you must disable the pre-empt option in the multi-WAN package.

24.7.1. Set Multi-WAN Options For Pre-Empt Disabled

To disable PMP + roaming pre-empt, in the top menu, select **Network -> Multi-Wan**.

In the Multi-WAN page, ensure Pre-empt is not selected.

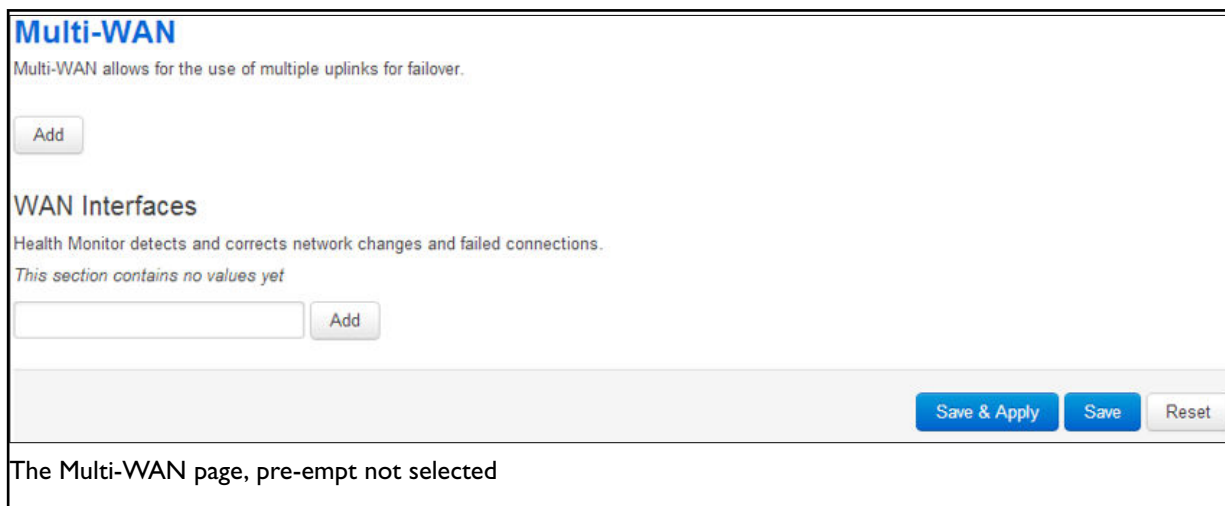

Click **Save & Apply**.

In the top menu, select **System -> Reboot**. The System Reboot page appears.

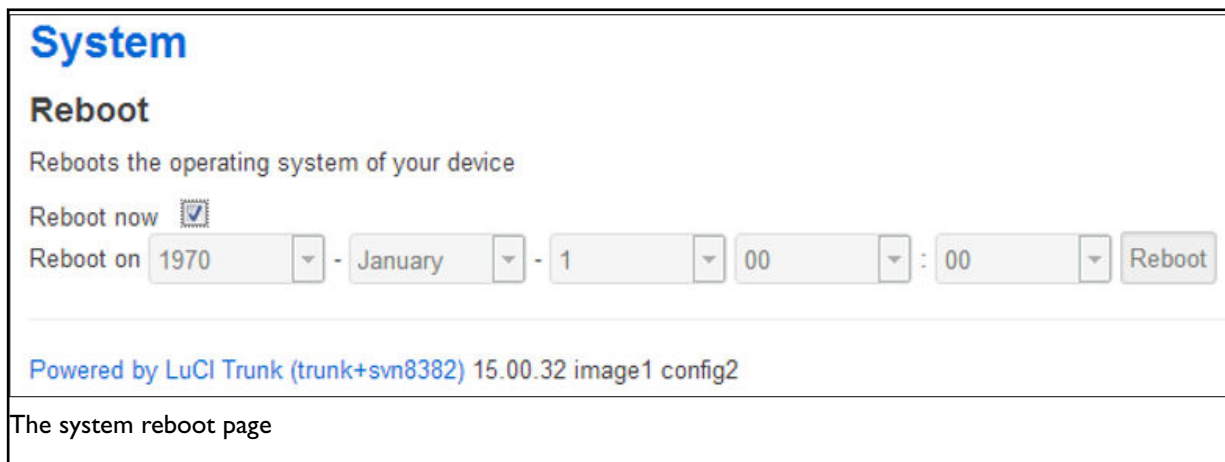

Check the **Reboot now** check box and then click **Reboot**.

24.8. Scenario 3: No PMP + Roaming

In this scenario there is no PMP interface that can be used for a connection. The router scans the available mobile networks at boot and sorts the networks according to signal strength.

The network that offers the best signal strength will be the first to connect. Multi-WAN then controls the failover between the available networks.

Multi-WAN periodically does a health check on the interface. A health check comprises of a configurable combination of the following:

- Interface state
- Pings to an ICMP target
- Signal level checks using signal threshold, RSCP threshold and ECIO threshold option values

A fail for any of the above health checks results in a fail. After a configurable number of health check failures, Multi-WAN will disconnect the failed interface and attempt to connect to the next best roaming interface.

24.8.1. Set Options For Automatically Created Interfaces (Failover)

In the top menu on the web interface page, select **Services -> Mobile Manager**. The Mobile Manager page appears.

There are five sections in the mobile manager page:

Section	Description
Basic settings	Enable SMS, configure SIM pin code, select roaming SIM, collect ICCIDs and set IMSI.
Advanced	Configure advanced options such as collect ICCIDs and temperature polling interval.
CDMA*	CDMA configuration
Callers	Configure callers that can use SMS.
Roaming Interface Template	Configure Preferred Roaming List options.
*Option available only for Telit CE910-SL module.	

24.8.2. Basic Settings

Web Field/UCI/Package Option	Description				
Web: SMS Enable UCI: mobile.main.sms Opt: sms	Enables SMS. <table border="1"> <tr> <td>Default: yes</td> <td>Enabled</td> </tr> <tr> <td>no</td> <td>Disabled</td> </tr> </table>	Default: yes	Enabled	no	Disabled
Default: yes	Enabled				
no	Disabled				
Web: Collect ICCIDs UCI: mobile.main.init_get_iccids Opt: init_get_iccids	Enables or disables integrated circuit card identifier ICCID's collection functionality. If enabled then both SIM 1 and SIM 2 ICCIDs will be collected otherwise it will default to SIM 1. This will be display under mobile stats. <table border="1"> <tr> <td>Default: yes</td> <td>Enabled</td> </tr> <tr> <td>no</td> <td>Disabled</td> </tr> </table>	Default: yes	Enabled	no	Disabled
Default: yes	Enabled				
no	Disabled				
Web: PIN code for SIM1 UCI: mobile.main.sim2pin Opt: sim2pin	Depending on the SIM card specify the pin code for SIM 1. <table border="1"> <tr> <td>Default</td> <td>Blank</td> </tr> <tr> <td>Range</td> <td></td> </tr> </table>	Default	Blank	Range	
Default	Blank				
Range					
Web: PIN code for SIM2 UCI: mobile.main.sim2pin Opt: sim2pin	Depending on the SIM card specify the pin code for SIM 2. <table border="1"> <tr> <td>Default</td> <td>Blank</td> </tr> <tr> <td>Range</td> <td></td> </tr> </table>	Default	Blank	Range	
Default	Blank				
Range					
Web: HDR Auto User ID UCI: mobile.main.hdr_userid Opt: hdr_userid	AN-PPP user ID. Supported on Cellient (CDMA) modem only. <table border="1"> <tr> <td>Default</td> <td>Blank</td> </tr> <tr> <td>Range</td> <td></td> </tr> </table>	Default	Blank	Range	
Default	Blank				
Range					

24.8.3. Caller Settings

Web Field/UCI/Package Option	Description				
Web: Name UCI: mobile.@caller[0].name Opt: name	Name assigned to the caller. <table border="1"> <tr> <td>Default</td> <td>Blank</td> </tr> <tr> <td>Range</td> <td></td> </tr> </table>	Default	Blank	Range	
Default	Blank				
Range					
Web: Number UCI: mobile.main.init_get_iccids Opt: init_get_iccids	Number of the caller allowed to SMS the router. Add in specific caller numbers or use the wildcard symbol. <table border="1"> <tr> <td>Default</td> <td>Blank</td> </tr> <tr> <td>Range</td> <td></td> </tr> </table>	Default	Blank	Range	
Default	Blank				
Range					
Web: Enable UCI: mobile.main.sim2pin Opt: sim2pin	Enables or disables incoming caller ID. <table border="1"> <tr> <td>Default: no</td> <td>Disabled</td> </tr> <tr> <td>yes</td> <td>Enabled</td> </tr> </table>	Default: no	Disabled	yes	Enabled
Default: no	Disabled				
yes	Enabled				
Web: Respond UCI: mobile.@caller[0].respond Opt: respond	If checked, the router will return an SMS. Select Respond if you want the router to reply. <table border="1"> <tr> <td>Default: 0</td> <td>Disabled</td> </tr> <tr> <td>1</td> <td>Enabled</td> </tr> </table>	Default: 0	Disabled	1	Enabled
Default: 0	Disabled				
1	Enabled				

24.8.4. Configuring No PMP + Roaming Using UCI

The roaming interface configuration file is stored in the mobile package

/etc/config/mobile. To view the mobile package, enter:

```
root@VA_router:~# uci export mobile

package mobile config mobile 'main'

option sms 'yes'

option roaming_sim '1'

option debug '1'

config caller

option name 'Eval'

option number '*#'

option enabled 'yes'

option respond 'yes'

config roaming_template

option roaming_sim '1'

option firewall_zone 'wan'

option apn 'test IE'

option username 'test'

option password 'test'

option service 'umts'

option health_fail_retries '2'

option signal_threshold '-100'

option priority '5'

option ifup_timeout_sec '180'

option defaultroute 'yes'

option sort_sig_strength 'yes'

option ifup_retry_sec '200'

option health_interval '120'

option icmp_hosts '172.31.4.129'

option timeout '3'

option health_recovery_retries '3'
```

To view the mobile package via uci commands, enter:

```
root@VA_router:~# uci show mobile

mobile.main=mobile

mobile.main.sms=yes

mobile.main.roaming_sim=1

mobile.main.debug=1

mobile.@caller[0]=caller

mobile.@caller[0].name=Eval

mobile.@caller[0].number=*

mobile.@caller[0].enabled=yes

mobile.@caller[0].respond=yes

mobile.@roaming_template[0]=roaming_template

mobile.@roaming_template[0].roaming_sim=1

mobile.@roaming_template[0].firewall_zone=wan

mobile.@roaming_template[0].apn=stream.co.uk

mobile.@roaming_template[0].username=default

mobile.@roaming_template[0].password=void

mobile.@roaming_template[0].service=umts

mobile.@roaming_template[0].health_fail_retries=2

mobile.@roaming_template[0].signal_threshold=-100

mobile.@roaming_template[0].priority=5

mobile.@roaming_template[0].ifup_timeout_sec=180

mobile.@roaming_template[0].defaultroute=yes

mobile.@roaming_template[0].sort_sig_strength=yes

mobile.@roaming_template[0].ifup_retry_sec=200

mobile.@roaming_template[0].health_interval=120

mobile.@roaming_template[0].icmp_hosts=172.31.4.129

mobile.@roaming_template[0].timeout=3

mobile.@roaming_template[0].health_recovery_retries=3
```

The multiwan package is stored on **/etc/config/multiwan**. To view the multiwan package, enter:

```
root@VA_router:~# uci export multiwan

package multiwan

config multiwan 'config'

option enabled 'yes'

option preempt 'no'

option alt_mode 'no'
```

To see multiwan package via uci, enter:

```
root@VA_router:~# uci show multiwan
multiwan.config=multiwan
multiwan.config.enabled=yes
multiwan.config.preempt=no
multiwan.config.alt_mode=no
```

24.8.5. Roaming Interface Template: Web Interface

Roaming Interface Template
Common config values for interfaces created by Automatic Operator Selection

Interface Signal Sort Sort interfaces by signal strength so those having better signal strength at the startup would be tried first

Roaming SIM In which slot roaming sim-card is inserted

Firewall Zone

- lan:
- wan:
- unspecified -or- create:

Append all the generated interfaces to this zone

APN

PIN

PAP/CHAP username

PAP/CHAP password

Service Preference Order of service preference for the generated interfaces (Use Control button to select multiple)

Health Monitor Interval

Health Monitor ICMP Host(s)

Health Monitor Conntrack Test Host(s)

Health Monitor ICMP Timeout

Health Monitor ICMP Interval

Attempts Before WAN Failover

Attempts Before WAN Recovery

The roaming interface template page

Web Field/UCI/Package Option	Description						
Web: Interface Signal Sort UCI: mobile.@roaming_template[0].sort_sig_strength Opt: sort_sig_strength	Sorts interfaces by signal strength priority, so those that have a better signal strength will be tried first. <table border="1"> <tr> <td>0</td> <td>Disabled</td> </tr> <tr> <td>1</td> <td>Enabled</td> </tr> </table>	0	Disabled	1	Enabled		
0	Disabled						
1	Enabled						
Web: Roaming SIM UCI: mobile.main.roaming_sim Opt: roaming_sim	Sets in which slot to insert roaming SIM card. <table border="1"> <tr> <td>1</td> <td>SIM slot 1</td> </tr> <tr> <td>2</td> <td>SIM slot 2</td> </tr> </table>	1	SIM slot 1	2	SIM slot 2		
1	SIM slot 1						
2	SIM slot 2						
Web: Firewall Zone UCI: mobile.@roaming_template[0].firewall_zone Opt: firewall_zone	Adds all generated interfaces to this zone. Select existing zone or click unspecified or create to create new zone.						
Web: APN UCI: mobile.@roaming_template[0].apn Opt: apn	APN name of Mobile Network Operator.						
Web: PIN UCI: mobile.@roaming_template[0].pincode Opt: pincode	SIM card's PIN number.						
Web: PAP/CHAP username UCI: mobile.@roaming_template[0].username Opt: username	Username used to connect to APN.						
Web: PAP/CHAP password UCI: mobile.@roaming_template[0].password Opt: password	Password used to connect to APN.						
Web: Service Order UCI: mobile.@roaming_template[0].service_order Opt: service_order	Defines a space separated list of services, in preferred order. Valid options are gprs, umts, lte, auto. If no valid_service order is defined, then the configured Service Type is used. Example: mobile.@roaming_template[0].service_order="gprs umts lte auto" <table border="1"> <tr> <td>Default</td> <td>Blank. Automatically detect best service.</td> </tr> <tr> <td>Range</td> <td>gprs umts lte auto</td> </tr> </table>	Default	Blank. Automatically detect best service.	Range	gprs umts lte auto		
Default	Blank. Automatically detect best service.						
Range	gprs umts lte auto						
Web: Health Monitor Interval UCI:	Sets the period, in seconds, to check the health status of the interface. The Health Monitor interval will be used for: <ul style="list-style-type: none"> • Interface state checks • Ping interval • Signal strength checks <table border="1"> <tr> <td>Default</td> <td>10. Health checks every 10 seconds.</td> </tr> <tr> <td>Range</td> <td></td> </tr> </table>	Default	10. Health checks every 10 seconds.	Range			
Default	10. Health checks every 10 seconds.						
Range							
Web: Health Monitor ICMP Host(s) UCI: mobile.@roaming_template[0].icmp_host_s	Specifies target IP address for ICMP packets. <table border="1"> <thead> <tr> <th>Web</th> <th>Description</th> <th>UCI</th> </tr> </thead> <tbody> <tr> <td></td> <td></td> <td></td> </tr> </tbody> </table>	Web	Description	UCI			
Web	Description	UCI					

Web Field/UCI/Package Option	Description														
Opt: icmp_hosts	Disable	Disables the option.	disable												
	DNS servers	DNS IP addresses will be used.	dns												
	WAN gateway	Gateway IP address will be used.	gateway												
	custom	Ability to provide IP address. Multiple pings targets can be entered, comma separated. Pings to both must fail for health check to fail. Example: option icmp_hosts '1.1.1.1,2.2.2.2'													
Web: Health Monitor Contrack Test Host(s) UCI: mobile.@roaming_template[0].contrack_hosts Opt: contrack_hosts	<p>Contrack is the feature used to track if there is any traffic to and from an IP destination within the health interval.</p> <p>The Contrack_hosts option defines the IP for contrack to track, usually the icmp_host IP is used.</p> <p>If traffic to the contrack_hosts IP is detected then multiwan does not send a ping health check to the icmp_host; otherwise a ping is sent as normal to the icmp_host.</p> <p>By default the contrack_hosts is checked if the health interval is greater than 5 minutes. This time threshold currently cannot be manipulated.</p> <p>Contrack is generally used to limit the traffic sent on a GSM network.</p> <table border="1"> <thead> <tr> <th>Web</th> <th>Description</th> <th>UCI</th> </tr> </thead> <tbody> <tr> <td>Default</td> <td>Contrack checks for traffic from icmp_host IP when health_interval is greater than 5 minutes.</td> <td></td> </tr> <tr> <td>Disable</td> <td>Contrack checks for traffic from icmp_host IP when health_interval is greater than 5 minutes.</td> <td>disable</td> </tr> <tr> <td>custom</td> <td>Specifies an IP other than the icmp_host for contrack to track.</td> <td></td> </tr> </tbody> </table>			Web	Description	UCI	Default	Contrack checks for traffic from icmp_host IP when health_interval is greater than 5 minutes.		Disable	Contrack checks for traffic from icmp_host IP when health_interval is greater than 5 minutes.	disable	custom	Specifies an IP other than the icmp_host for contrack to track.	
Web	Description	UCI													
Default	Contrack checks for traffic from icmp_host IP when health_interval is greater than 5 minutes.														
Disable	Contrack checks for traffic from icmp_host IP when health_interval is greater than 5 minutes.	disable													
custom	Specifies an IP other than the icmp_host for contrack to track.														
Web: Health Monitor ICMP Timeout UCI: mobile.@roaming_template[0].timeout Opt: timeout	<p>Specifies the time in seconds that Health Monitor ICMP will timeout at.</p> <p>Sets ping timeout in seconds. Choose the time in seconds that the health monitor ICMP will timeout at.</p> <table border="1"> <tbody> <tr> <td>Default</td> <td>3. Wait 3 seconds for ping reply.</td> </tr> <tr> <td>Range</td> <td></td> </tr> </tbody> </table>			Default	3. Wait 3 seconds for ping reply.	Range									
Default	3. Wait 3 seconds for ping reply.														
Range															
Web: Health Monitor ICMP Interval UCI: mobile.@roaming_template[0].interval Opt: icmp_interval	<p>Defines the interval, in seconds, between multiple pings sent at each health check.</p> <table border="1"> <tbody> <tr> <td>Default</td> <td>1</td> </tr> <tr> <td>Range</td> <td></td> </tr> </tbody> </table>			Default	1	Range									
Default	1														
Range															
Web: Attempts Before WAN Failover UCI: mobile.@roaming_template[1].health_fail_retries Opt: health_fail_retries	<p>Defines the number of health check failures before interface is disconnected.</p> <table border="1"> <tbody> <tr> <td>Default</td> <td>3</td> </tr> <tr> <td>Range</td> <td></td> </tr> </tbody> </table>			Default	3	Range									
Default	3														
Range															
Web: Attempts Before WAN Recovery UCI: mobile.@roaming_template[0].health_recovery_retries Opt: health_recovery_retries	<p>Sets the number of health check passes before the interface is considered healthy. This field is not used for a roaming template.</p> <table border="1"> <tbody> <tr> <td>Default</td> <td>5</td> </tr> <tr> <td>Range</td> <td></td> </tr> </tbody> </table>			Default	5	Range									
Default	5														
Range															

Web Field/UCI/Package Option	Description				
Web: Priority UCI: mobile.@roaming_template[0].priority Opt: priority	Type the priority number. The higher the value, the higher the priority. This multi-WAN interface priority must be lower than the one specified in the priority field for the PMP interface. <table border="1"> <tr> <td>Default</td> <td>0</td> </tr> <tr> <td>Range</td> <td></td> </tr> </table>	Default	0	Range	
Default	0				
Range					
Web: Multi-WAN: Exclusive Group UCI: mobile.@roaming_template[0].multiwan_exclusive_group Opt: multiwan_exclusive_group	Specifies the Multi-WAN group for the generated roaming interfaces. Defaults to '3g' if not specified.				
Web: Minimum ifup interval UCI: multiwan.wan.ifup_retry_sec Opt: ifup_retry_sec	Not used for a roaming interface. <table border="1"> <tr> <td>Default</td> <td>300. Retry primary interface every 300 seconds.</td> </tr> <tr> <td>Range</td> <td></td> </tr> </table>	Default	300. Retry primary interface every 300 seconds.	Range	
Default	300. Retry primary interface every 300 seconds.				
Range					
Web: Interface Start Timeout UCI: mobile.@roaming_template[0].ifup_timeout_sec Opt: ifup_timeout	Specifies the time in seconds for interface to start up. If it is not up after this period, it will be considered a fail. <table border="1"> <tr> <td>Default</td> <td>40</td> </tr> <tr> <td>1</td> <td>Enabled</td> </tr> </table>	Default	40	1	Enabled
Default	40				
1	Enabled				
Web: Signal Threshold (dBm) UCI: mobile.@roaming_template[0].signal_threshold Opt: signal_threshold	Specifies the minimum RSCP signal strength in dBm before considering if the interface fails signal health check. Uses the value stored for rscp_dbm in mobile diagnostics. <table border="1"> <tr> <td>Default</td> <td>-115dBm</td> </tr> <tr> <td>Range</td> <td>-46 to -115 dBm</td> </tr> </table>	Default	-115dBm	Range	-46 to -115 dBm
Default	-115dBm				
Range	-46 to -115 dBm				

When you have configured your settings, click **Save & Apply**.

System

Reboot

Reboots the operating system of your device

Reboot now

Reboot on 1970 - January - 1 00 : 00 Reboot

Powered by LuCI Trunk (trunk+svn8382) 15.00.32 image1 config2

The reboot page

In the top menu, select **System** -> **Reboot**. The System page appears.

Check the **Reboot now** check box and then click **Reboot**.

24.8.6. Set Multi-WAN Options For Primary Predefined Interface

On the web interface go to **Network** -> **Multi-Wan**. The Multi-WAN page appears.

Multi-WAN
Multi-WAN allows for the use of multiple uplinks for failover.

WAN Interfaces
Health Monitor detects and corrects network changes and failed connections.
This section contains no values yet

The Multi-WAN page

In the WAN Interfaces section, type in the name of the Multi-WAN interface. Click **Add**. The Multi-WAN page appears.

Multi-WAN

Multi-WAN allows for the use of multiple uplinks for failover.

Enable

Preempt

Alternate Mode [?](#) It will use alternate interface after reboot

Delete

WAN Interfaces

Health Monitor detects and corrects network changes and failed connections.

Delete

3G_S1_VODA

Health Monitor Interval 10 sec.

Health Monitor ICMP Host(s) DNS Server(s)

Health Monitor ICMP Timeout 3 sec.

Attempts Before WAN Failover 3

Attempts Before WAN Recovery 5

Priority 0 [?](#) Higher value is higher priority

Manage Interface State (Up/Down)

Exclusive Group 0 [?](#) Only one interface in group could be up in the same time

Minimum ifup Interval 300 sec. [?](#) Minimum interval between two successive interface start attempts

Interface Start Timeout 40 sec. [?](#) Time for interface to startup

Signal Threshold (dBm) -115 [?](#) Below is a failure

Add

Save & Apply

Save

Reset

The Multi-WAN page

Web Field/UCI/Package Option	Description								
Web: Enable UCI: multiwan.config.enabled Opt: enabled	Enables multiwan. <table border="1"> <tr> <td>0</td> <td>Disabled</td> </tr> <tr> <td>1</td> <td>Enabled</td> </tr> </table>	0	Disabled	1	Enabled				
0	Disabled								
1	Enabled								
Web: Preempt UCI: multiwan.config.preempt Opt: preempt	Enables or disables pre-emption for multiwan. If enabled, the router will keep trying to connect to a higher priority interface depending on timer set. <table border="1"> <tr> <td>0</td> <td>Disabled</td> </tr> <tr> <td>1</td> <td>Enabled</td> </tr> </table>	0	Disabled	1	Enabled				
0	Disabled								
1	Enabled								
Web: Alternate Mode UCI: multiwan.config.alt Opt: alt	Enables or disables alternate mode for multiwan. If enabled, the router will use an alternate interface after reboot. <table border="1"> <tr> <td>0</td> <td>Disabled</td> </tr> <tr> <td>1</td> <td>Enabled</td> </tr> </table>	0	Disabled	1	Enabled				
0	Disabled								
1	Enabled								
Web: WAN Interfaces UCI: multiwan.3g_s<sim-number>_<short-operator-name> Opt: 3g_s<sim-number>_<short-operator-name>	Provide the same interface name as chosen in multiwan section below and click Add .								
Web: Health Monitor Interval UCI: multiwan[.x.].health_interval Opt: health_interval	Sets the period to check the health status of the interface. The Health Monitor interval will be used for: <ul style="list-style-type: none"> • Interface state checks • Ping interval • Signal strength checks 								
Web: Health Monitor ICMP Host(s) UCI: multiwan[.x.].icmp_hosts Opt: icmp_hosts	Specifies the target IP address for ICMP packets. <table border="1"> <tr> <td>Disable</td> <td>Disables the option</td> </tr> <tr> <td>DNS servers</td> <td>DNS IP addresses will be used.</td> </tr> <tr> <td>WAN Gateway</td> <td>Gateway IP address will be used.</td> </tr> <tr> <td>Custom</td> <td>Ability to provide IP address.</td> </tr> </table>	Disable	Disables the option	DNS servers	DNS IP addresses will be used.	WAN Gateway	Gateway IP address will be used.	Custom	Ability to provide IP address.
Disable	Disables the option								
DNS servers	DNS IP addresses will be used.								
WAN Gateway	Gateway IP address will be used.								
Custom	Ability to provide IP address.								
Web: Health Monitor Contrack Test Host(s) UCI: multiwan.wan.contrack_hosts Opt: contrack_hosts	Contrack is the feature used to track if there is any traffic to and from an IP destination within the health interval. Contrack_hosts option defines the IP for contrack to track – usually the icmp_host IP is used. If traffic to the contrack_hosts IP is detected then multiwan does not send a ping health check to the icmp_host otherwise a ping is sent as normal to the icmp_host. By default the contrack_hosts is checked if the health interval is greater than 5 minutes. This time threshold currently cannot be manipulated. Contrack is generally used to limit the traffic sent on a GSM network. <table border="1"> <tr> <td>Default</td> <td>Contrack checks for traffic from icmp_host IP when health_interval is greater than 5 minutes.</td> </tr> <tr> <td>Disable</td> <td>Contrack is Disabled.</td> </tr> <tr> <td>Custom</td> <td>Specifies an IP other than the icmp_host for contrack to track.</td> </tr> </table>	Default	Contrack checks for traffic from icmp_host IP when health_interval is greater than 5 minutes.	Disable	Contrack is Disabled.	Custom	Specifies an IP other than the icmp_host for contrack to track.		
Default	Contrack checks for traffic from icmp_host IP when health_interval is greater than 5 minutes.								
Disable	Contrack is Disabled.								
Custom	Specifies an IP other than the icmp_host for contrack to track.								
Web: Health Monitor ICMP Timeout UCI: multiwan[.x.].timeout Opt: timeout	Sets ping timeout in seconds. Choose the time in seconds that the health monitor ICMP will timeout at. <table border="1"> <tr> <td>3</td> <td>Wait 3 seconds for ping reply.</td> </tr> <tr> <td>Range</td> <td></td> </tr> </table>	3	Wait 3 seconds for ping reply.	Range					
3	Wait 3 seconds for ping reply.								
Range									

Web Field/UCI/Package Option	Description				
Web: Health Monitor ICMP Interval UCI: multiwan.wan.icmp_interval Opt: icmp_interval	Defines the interval between multiple pings sent at each health check. <table border="1"> <tr><td>1</td><td></td></tr> <tr><td>Range</td><td></td></tr> </table>	1		Range	
1					
Range					
Web: Health Monitor ICMP Count UCI: multiwan.wan.icmp_count Opt: icmp_count	Defines the number of pings to send at each health check. <table border="1"> <tr><td>1</td><td></td></tr> <tr><td>Range</td><td>Enabled</td></tr> </table>	1		Range	Enabled
1					
Range	Enabled				
Web: Attempts Before WAN Failover UCI: multiwan.[..].health_fail_retries Opt: health_fail_retries	Sets the amount of health monitor retries before the interface is considered a failure. <table border="1"> <tr><td>3</td><td></td></tr> <tr><td>Range</td><td></td></tr> </table>	3		Range	
3					
Range					
Web: Attempts Before WAN Recovery UCI: multiwan.[..].health_recovery_retries Opt: health_recovery_retries	Sets the number of health monitor checks before the interface is considered healthy. Only relevant if pre-empt mode is enabled. <table border="1"> <tr><td>5</td><td></td></tr> <tr><td>Range</td><td></td></tr> </table>	5		Range	
5					
Range					
Web: Priority UCI: multiwan.[..].priority Opt: priority	Specifies the priority of the interface. The higher the value, the higher the priority. This multiwan interface priority must be higher than the one specified in the priority field in the 'Roaming Interface Template' page described in the following section. <table border="1"> <tr><td>0</td><td></td></tr> <tr><td>Range</td><td></td></tr> </table>	0		Range	
0					
Range					
Web: Exclusive Group UCI: multiwan.[..].exclusive_group Opt: exclusive_group	Defines the group to which the interface belongs; only one interface can be active. <table border="1"> <tr><td>0</td><td></td></tr> <tr><td>Range</td><td></td></tr> </table>	0		Range	
0					
Range					
Web: Manage Interface State (Up/Down) UCI: multiwan.[..].manage_state Opt: manage_state	Defines whether multiwan will start and stop the interface. Select Enabled . <table border="1"> <tr><td>0</td><td>Disabled</td></tr> <tr><td>1</td><td>Enabled</td></tr> </table>	0	Disabled	1	Enabled
0	Disabled				
1	Enabled				
Web: Minimum ifup Interval UCI: multiwan.[..].ifup_retry_sec Opt: ifup_retry_sec	Specifies the interval in seconds before retrying the primary interface when pre-empt mode is enabled.				
Web: Interface Start Timeout UCI: multiwan.[..].ifup_timeout Opt: ifup_timeout	Specifies the time in seconds for interface to start up. If it is not up after this period, it will be considered a fail. Choose timer greater than 120 seconds. <table border="1"> <tr><td>40</td><td>40 Seconds</td></tr> <tr><td>Range</td><td></td></tr> </table>	40	40 Seconds	Range	
40	40 Seconds				
Range					
Web: Signal Threshold (dBm) UCI: multiwan.[..].signal_threshold Opt: signal_threshold	Specifies the minimum signal strength in dBm before considering if the interface fails signal health check. Uses the value stored for sig_dbm in mobile diagnostics. <table border="1"> <tr><td>-115</td><td>Disabled</td></tr> <tr><td>Range</td><td>-46 to -115dBm</td></tr> </table>	-115	Disabled	Range	-46 to -115dBm
-115	Disabled				
Range	-46 to -115dBm				
Web: RSCP Threshold (dBm) UCI: multiwan.[..].rscp_threshold	Specifies the minimum RSCP signal strength in dBm before considering if the interface fails signal health check. Uses the value stored for rscp_dbm in mobile diagnostics.				

Web Field/UCI/Package Option	Description																
Opt: rscp_threshold																	
Web: ECIO Threshold (dB) UCI: multiwan,[.x..].ecio_threshold Opt: ecio_threshold	Specifies the minimum ECIO signal strength in dB before considering if the interface fails signal health check. Uses the value stored for ecio_db in mobile diagnostics.																
Web: Signal Test UCI: multiwan,[.x..].signal_test Opt: signal_test	<p>Defines script to test various signal characteristics in multiwan signal test. For example:</p> <pre>option signal_test '(tech == 0) then (sig_dbm > -70) else (rscp_dbm > -105 and ecio_db > -15)'</pre> <p>This states that when technology is GSM a health fail is determined when signal strength is less than -70dBm. When technology is not GSM a health fail occurs when either rscp_dbm falls below -105dBm or ecio_db falls below -15dB.</p> <p>Tech values are:</p> <table border="1"> <tbody> <tr><td>0</td><td>GSM</td></tr> <tr><td>1</td><td>GSM Compact</td></tr> <tr><td>2</td><td>UTRAN</td></tr> <tr><td>3</td><td>GSM w/EGPRS</td></tr> <tr><td>4</td><td>UTRAN w/HSPDA</td></tr> <tr><td>5</td><td>UTRAN w/HSUPA</td></tr> <tr><td>6</td><td>UTRAN w/HSUPA and HSDPA</td></tr> <tr><td>7</td><td>E-UTRAN</td></tr> </tbody> </table>	0	GSM	1	GSM Compact	2	UTRAN	3	GSM w/EGPRS	4	UTRAN w/HSPDA	5	UTRAN w/HSUPA	6	UTRAN w/HSUPA and HSDPA	7	E-UTRAN
0	GSM																
1	GSM Compact																
2	UTRAN																
3	GSM w/EGPRS																
4	UTRAN w/HSPDA																
5	UTRAN w/HSUPA																
6	UTRAN w/HSUPA and HSDPA																
7	E-UTRAN																

Click **Save**.

24.9. Configuring Automatic Operator Selection Via UCI

While the router boots up it checks for mobile networks. Based on available networks, the router creates interfaces and the multiwan package is used to run failover between interfaces. Typically these auto-generated interfaces are sorted by signal strength.

Details for these interfaces are provided in the mobile package. When you have created the interfaces, Multi-WAN manages the operation of primary (predefined) and failover (auto created) interfaces.

Multi-WAN periodically does a health check on the active interface. A health check comprises of a configurable combination of the following:

- interface state
- pings to an ICMP target
- signal level checks using signal threshold, RSCP threshold and ECIO threshold option values

A fail for any of the above health checks results in an overall fail. After a configurable number of health check failures, multiwan will move to the next highest priority interface. Multi-WAN will optionally stop the failed interface and start the new interface, if required.

24.9.1. PMP + Roaming: Pre-Empt & Disabled Using UCI PMP interface configuration

The PMP interface is configured in the network package /etc/config/network. To view the network configuration file, enter:

To view the mobile configuration file, enter:

```
root@VA_router:~# uci export network

package network

config interface 'loopback'

option ifname 'lo'

option proto 'static'

option ipaddr '127.0.0.1'

option netmask '255.0.0.0'

config interface 'lan'

option ifname 'eth0'

option proto 'static'

option ipaddr '192.168.100.1'

option netmask '255.255.255.0'

config interface '3g_sl_voda'

option auto '0'

option proto '3g'

option service_order 'auto lte umts gprs'

option apn 'testIE'

option username 'test'

option password 'test'

option sim '1'    option operator 'vodafone IE'
```

To view uci commands, enter:

```
root@VA_router:~#uci show network

network.loopback=interface
network.loopback.ifname=lo
network.loopback.proto=static
network.loopback.ipaddr=127.0.0.1
network.loopback.netmask=255.0.0.0

network.lan=interface
network.lan.ifname=eth0
network.lan.proto=static
network.lan.ipaddr=192.168.100.1
network.lan.netmask=255.255.255.0

network.3g_s1_voda=interface
network. 3g_s1_voda.auto=0
network. 3g_s1_voda.proto=3g
network. 3g_s1_voda.service_order='auto lte umts gprs'
network. 3g_s1_voda.apn=test IE
network. 3g_s1_voda.username=test
network. 3g_s1_voda.password=test
network. 3g_s1_voda.sim=1
network. 3g_s1_voda.operator=vodafone IE
```

Roaming Interface Configuration Using UCI

The roaming interface configurations are stored in the mobile package

/etc/config/mobile.

To view the mobile configuration file, enter:

```
root@VA_router:~# uci export mobile
config mobile 'main'
option sms 'yes'
option roaming_sim '1'
option init_get_iccids 'no'
config caller
option name 'Test'
option number '*'
option enabled 'yes'
option respond 'yes'
config roaming_template
option roaming_sim '1'
option firewall_zone 'wan'
option apn 'test IE'
option username 'test'
option password 'test'
option service 'umts'
option health_interval '4'
option icmp_hosts 'disable'
option timeout 'disable'
option health_fail_retries '3'
option signal_threshold '-95'
option priority '5'
option ifup_retry_sec '120'
option ifup_timeout_sec '180'
option defaultroute 'yes'
option sort_sig_strength 'yes'
```

To view the uci command of package mobile, enter:

```
root@VA_router:~#uci show mobile

mobile.main=mobile

mobile.main.sms=yes

mobile.main.roaming_sim=1

mobile.main.init_get_iccids=no

mobile.@caller[0]=caller

mobile.@caller[0].name=Test

mobile.@caller[0].number=*

mobile.@caller[0].enabled=yes

mobile.@caller[0].respond=yes

mobile.@roaming_template[0]=roaming_template

mobile.@roaming_template[0].roaming_sim=1

mobile.@roaming_template[0].firewall_zone=wan

mobile.@roaming_template[0].apn=test IE

mobile.@roaming_template[0].username=test

mobile.@roaming_template[0].password=test

mobile.@roaming_template[0].service=umts

mobile.@roaming_template[0].health_interval=4

mobile.@roaming_template[0].icmp_hosts=disable

mobile.@roaming_template[0].timeout=disable

mobile.@roaming_template[0].health_fail_retries=3

mobile.@roaming_template[0].signal_threshold=-95

mobile.@roaming_template[0].priority=5

mobile.@roaming_template[0].ifup_retry_sec=120

mobile.@roaming_template[0].ifup_timeout_sec=180

mobile.@roaming_template[0].defaultroute=yes

mobile.@roaming_template[0].sort_sig_strength=yes
```

Multi-WAN Configuration Using UCI

The configuration file for package multiwan is stored on `/etc/config/multiwan`

To see configuration file of mobile package, enter:

```
root@VA_router:~# cat /etc/config/multiwan
config multiwan 'config'
option enabled '1'
option preempt '1'
config interface '3g_s1_voda'
option health_fail_retries '3'
option health_interval '3'
option timeout '1'
option icmp_hosts 'disable' option priority '10'
option exclusive_group '3g' option signal_threshold '-95'
option ifup_retry_sec '350'
option ifup_timeout_sec '180'
option manage_state '1'
```

To view the uci command of package multiwan, enter:

```
root@VA_router:~# uci show multiwan
multiwan.config=multiwan
multiwan.config.enabled=1
multiwan.config.preempt=1
multiwan.main_voda=interface
multiwan.main_voda.health_fail_retries=3
multiwan.main_voda.health_interval=3
multiwan.3g_s1_voda.timeout=1
multiwan.3g_s1_voda.icmp_hosts=disable
multiwan.3g_s1_main_voda.priority=10
multiwan.3g_s1_voda.exclusive_group=3g
multiwan.3g_s1_voda.signal_threshold=-95
multiwan.3g_s1_voda.ifup_retry_sec=350
multiwan.3g_s1_voda.ifup_timeout_sec=180
multiwan.3g_s1_voda.manage_state=1
```

The difference between PMP + roaming: pre-empt enabled and disabled is setting one option parameter. To disable pre-empt, enter:

```
uci set multiwan.config.preempt=0
uci commit
```



NOTE

Available values are:

0	Disabled
1	Enabled

24.9.2. Configuring No PMP + Roaming Using UCI

The roaming interface configuration file is stored in the mobile package

`/etc/config/mobile`. To view the mobile package, enter:

```
root@VA_router:~# uci export mobile

package mobile config mobile 'main'

option sms 'yes'

option roaming_sim '1'

option debug '1'

config caller

option name 'Eval'

option number '*#'

option enabled 'yes'

option respond 'yes'

config roaming_template

option roaming_sim '1'

option firewall_zone 'wan'

option apn 'test IE'

option username 'test'

option password 'test'

option service 'umts'

option health_fail_retries '2'

option signal_threshold '-100'

option priority '5'

option ifup_timeout_sec '180'

option defaultroute 'yes'

option sort_sig_strength 'yes'

option ifup_retry_sec '200'

option health_interval '120'

option icmp_hosts '172.31.4.129'

option timeout '3'

option health_recovery_retries '3'
```

To view the mobile package via uci commands, enter:

```
root@VA_router:~# uci show mobile

mobile.main=mobile

mobile.main.sms=yes

mobile.main.roaming_sim=1

mobile.main.debug=1

mobile.@caller[0]=caller

mobile.@caller[0].name=Eval

mobile.@caller[0].number=*

mobile.@caller[0].enabled=yes

mobile.@caller[0].respond=yes

mobile.@roaming_template[0]=roaming_template

mobile.@roaming_template[0].roaming_sim=1

mobile.@roaming_template[0].firewall_zone=wan

mobile.@roaming_template[0].apn=stream.co.uk

mobile.@roaming_template[0].username=default

mobile.@roaming_template[0].password=void

mobile.@roaming_template[0].service=umts

mobile.@roaming_template[0].health_fail_retries=2

mobile.@roaming_template[0].signal_threshold=-100

mobile.@roaming_template[0].priority=5

mobile.@roaming_template[0].ifup_timeout_sec=180

mobile.@roaming_template[0].defaultroute=yes

mobile.@roaming_template[0].sort_sig_strength=yes

mobile.@roaming_template[0].ifup_retry_sec=200

mobile.@roaming_template[0].health_interval=120

mobile.@roaming_template[0].icmp_hosts=172.31.4.129

mobile.@roaming_template[0].timeout=3

mobile.@roaming_template[0].health_recovery_retries=3
```

The multiwan package is stored on **/etc/config/multiwan**. To view the multiwan package, enter:

```
root@VA_router:~# uci export multiwan

package multiwan

config multiwan 'config'

option enabled 'yes'

option preempt 'no'

option alt_mode 'no'
```

To see multiwan package via uci, enter:

```
root@VA_router:~# uci show multiwan
multiwan.config=multiwan
multiwan.config.enabled=yes
multiwan.config.preempt=no
multiwan.config.alt_mode=no
```

24.9.3. Automatic Operator Selection Diagnostics Via The Web Interface

When interfaces are auto-created they are presented in the network and in the multiwan package.

To check interfaces created in the multiwan package, from the top menu, select **Network -> Multi-WAN**.

To check interfaces that have been created in the network package, from the top menu, select **Network -> Interfaces**.

Network	Status	Actions
3G_S1_O2IR 3g-3g_s1_o2ir	RX: 0.00 B (0 Pkts.) TX: 0.00 B (0 Pkts.)	Connect Stop Edit Delete
3G_S1_VODA 3g-3g_s1_voda	Uptime: 7h 31m 26s RX: 62.00 B (8 Pkts.) TX: 23.44 KB (329 Pkts.) IPv4: 10.140.1.23/32	Connect Stop Edit Delete
WCLIENT Client "0"	MAC Address: 00:00:00:00:00:00 RX: 0.00 B (0 Pkts.) TX: 0.00 B (0 Pkts.)	Connect Stop Edit Delete
LAN eth0	Uptime: 7h 35m 24s MAC Address: 00:E0:C8:10:1A:82 RX: 67.25 KB (502 Pkts.) TX: 132.29 KB (157 Pkts.) IPv4: 10.1.1.9/29	Connect Stop Edit Delete
LOOPBACK lo	Uptime: 7h 35m 30s MAC Address: 00:00:00:00:00:00 RX: 41.72 KB (516 Pkts.) TX: 41.72 KB (516 Pkts.) IPv4: 127.0.0.1/8 IPv6: 0:0:0:0:0:0:1/128	Connect Stop Edit Delete

The interface overview page

To check the status of the interface you are currently using, in the top menu, click **Status**. The Interface Status page appears.

Scroll down to the bottom of the page to view Multi-WAN Stats.

There are no active leases.

Multi-WAN Status

The multi-WAN status page

24.10. Automatic Operator Selection Diagnostics Via UCI

In this section, you can use UCI to check status of packages and various interfaces associated with automatic operator selection.

24.10.1. Check Roaming Interfaces Discovered

Roaming interfaces discovered during roaming search are stored at: `/var/const_state/roaming`.

This file contains a section for each discovered operator/service combination, along with signal strength, if tested. Time taken to scan is also available along with the time of scan and number of services found.

To check roaming interfaces discovered, enter:

```
root@VA_router:~# cat /var/const_state/roaming
roaming.main2_voda_lte=service
roaming.main2_voda_lte.name=vodafone IE
roaming.main2_voda_lte.shortname=voda IE
roaming.main2_voda_lte.opnum=27201
roaming.main2_voda_lte.interface=main2_voda
roaming.main2_voda_lte.servicetype=7
roaming.main2_voda_lte.sim=2
roaming.main2_voda_lte.tested=0
roaming.main2_voda_lte.signalstrength=0
roaming.main2_voda_ums=service
roaming.main2_voda_ums.name=vodafone IE
roaming.main2_voda_ums.shortname=voda IE
roaming.main2_voda_ums.opnum=27201
roaming.main2_voda_ums.interface=main2_voda
roaming.main2_voda_ums.servicetype=2
roaming.main2_voda_ums.sim=2
roaming.main2_voda_ums.tested=1
roaming.main2_voda_ums.signalstrength=-79
roaming.main2_voda_gprs=service
roaming.main2_voda_gprs.name=vodafone IE
roaming.main2_voda_gprs.shortname=voda IE
```

```
roaming.main2_voda_gprs.opnum=27201
roaming.main2_voda_gprs.interface=main2_voda
roaming.main2_voda_gprs.servicetype=0
roaming.main2_voda_gprs.sim=2
roaming.main2_voda_gprs.tested=0
roaming.main2_voda_gprs.signalstrength=0
roaming.main2_o2IR_ums.service
roaming.main2_o2IR_ums.name=o2 IRL
roaming.main2_o2IR_ums.shortname=o2 - IRL
roaming.main2_o2IR_ums.opnum=27202
roaming.main2_o2IR_ums.interface=main2_o2IR
roaming.main2_o2IR_ums.servicetype=2
roaming.main2_o2IR_ums.sim=2
roaming.main2_o2IR_ums.tested=1
roaming.main2_o2IR_ums.signalstrength=-85
roaming.main2_o2IR_gprs.service
roaming.main2_o2IR_gprs.name=o2 IRL
roaming.main2_o2IR_gprs.shortname=o2 - IRL
roaming.main2_o2IR_gprs.opnum=27202
roaming.main2_o2IR_gprs.interface=main2_o2IR
roaming.main2_o2IR_gprs.servicetype=0
roaming.main2_o2IR_gprs.sim=2
roaming.main2_o2IR_gprs.tested=0
roaming.main2_o2IR_gprs.signalstrength=0
roaming.status=status
roaming.status.num_services=5
roaming.status.scan_update_time=Thu May 12 05:02:38 2022
roaming.status.scan_duration=185
```

Roaming operators are also stored in MIB `vaModemRoaming.mib`.

24.10.2. Check Interfaces Created In Multiwan Package

To check interfaces created in the multiwan package, enter:

```
root@VA_router:~# cat/var/const_state/multiwan
multiwan.main2_3IRL=interface
multiwan.main2_3IRL.timeout=disable
multiwan.main2_3IRL.health_recovery_retries=5
multiwan.main2_3IRL.exclusive_group=3g
multiwan.main2_3IRL.manage_state=yes
multiwan.main2_3IRL.signal_threshold=-80
multiwan.main2_3IRL.ifup_timeout_sec=150
multiwan.main2_3IRL.icmp_hosts=disable
multiwan.main2_3IRL.health_interval=4
multiwan.main2_3IRL.priority=5
multiwan.main2_3IRL.ifup_retry_sec=120
multiwan.main2_3IRL.health_fail_retries=3
multiwan.main2_o2IR=interface
multiwan.main2_o2IR.timeout=disable
multiwan.main2_o2IR.health_recovery_retries=5
multiwan.main2_o2IR.exclusive_group=3g
multiwan.main2_o2IR.manage_state=yes
multiwan.main2_o2IR.signal_threshold=-80
multiwan.main2_o2IR.ifup_timeout_sec=150
multiwan.main2_o2IR.icmp_hosts=disable
multiwan.main2_o2IR.health_interval=4
multiwan.main2_o2IR.priority=5
multiwan.main2_o2IR.ifup_retry_sec=120
multiwan.main2_o2IR.health_fail_retries=3
```

24.10.3. Check Interfaces Created In Network Package

To check interfaces created in the network package, enter:

```
root@VA_router:~# cat /var/const_state/network
network.main2_3IRL=interface
network.main2_3IRL.snmp_alias_ifindex=3
network.main2_3IRL.sim=2
network.main2_3IRL.defaultroute=yes
network.main2_3IRL.username=campen1
network.main2_3IRL.apn=vpn.amylan.co.uk
network.main2_3IRL.opformat=2
network.main2_3IRL.phy=1-1
network.main2_3IRL.roaming_sim=2
network.main2_3IRL.operator=27205
network.main2_3IRL.password=campen1
network.main2_3IRL.auto=no
network.main2_3IRL.service_order=auto
network.main2_3IRL.proto=3g
network.main2_o2IR=interface
network.main2_o2IR.snmp_alias_ifindex=3
network.main2_o2IR.sim=2
network.main2_o2IR.defaultroute=yes
network.main2_o2IR.username=campen1
network.main2_o2IR.apn=vpn.amylan.co.uk
network.main2_o2IR.opformat=2
network.main2_o2IR.phy=1-1
network.main2_o2IR.roaming_sim=2
network.main2_o2IR.operator=27202
network.main2_o2IR.password=campen1
network.main2_o2IR.auto=no
network.main2_o2IR.service_order=auto
network.main2_o2IR.proto=3g
```

24.10.4. Check Current Interface

To check the SIM status of the interface you are currently using, enter:

```
root@VA_router:~# cat /var/const_state/mobile
mobile.3g_1_1=status
mobile.3g_1_1.sim2_iccid=89314404000075920976
mobile.3g_1_1.imei=866802020194140
mobile.3g_1_1.hw_rev=4534B04SIM7100E
mobile.3g_1_1.sim_select=yes
```

To check mobile status of the interface you are currently using, enter

```
root@VA_router:~# cat /var/state/mobile
mobile.3g_1_1=status
mobile.3g_1_1.auto_info=/tmp/3g_1-1.auto
mobile.3g_1_1.scan_update_time=Thu May 12 05:02:38 2018
mobile.3g_1_1.imsi=204043726930595
mobile.3g_1_1.imsi2=204043726930595
mobile.3g_1_1.lte_band=3
mobile.3g_1_1.last_error=no network service
mobile.3g_1_1.mcc=272 mobile.3g_1_1.last_error_time=2022-02-22 10:41:27
mobile.3g_1_1.lac=11
mobile.3g_1_1.cell=46542698
mobile.3g_1_1.mnc=05
mobile.3g_1_1.operator_code=27205
mobile.3g_1_1.operator_name=3 IRL DATA ONLY
mobile.3g_1_1.rscp_dbm=-86
mobile.3g_1_1.ecio_db=-8.5
mobile.3g_1_1.sig_dbm=-51
mobile.3g_1_1.temperature=37
mobile.3g_1_1.vam_state=connecting
mobile.3g_1_1.sim_slot=2
mobile.3g_1_1.sim_in=yes
mobile.3g_1_1.technology=UMTS
mobile.3g_1_1.registered=Roaming
mobile.3g_1_1.reg_code=5
mobile.3g_1_1.registered_pkt=Searching
mobile.3g_1_1.reg_code_pkt=2
```

25. Configuring Connection Watch (Cwatch)

Connection Watch is a recovery feature to enable dynamic recovery of an interface. You can configure multiple instances of Connection Watch.

Connection Watch consists of the following configurable instances:

- Interface(s) to be monitored
- Failure periods
- Recovery actions

If no data is received over the monitored interface during the configured duration, then the recovery action is performed. If more than one interface is specified under a single Connection Watch, the recovery action will be performed only if no data is received on both of the interfaces for the defined period.

Currently three configurable periods and associated recovery actions can be defined. Recovery actions are prioritised based on their configured failure periods, the smallest failure period having the lowest priority. Lowest priority actions are repeated until the next highest priority action executes at which point it then stops leaving only the new action to execute at configured intervals.

Example:

- Failure time 1 = 1 hour; Failure action 1= interface up
- Failure time 2 = 10 hours; Failure action 2 = interface restart
- Failure time 3 = 24 hours; Failure action 3 = reboot

In the above example action execution priorities are action 3 > action 2 > action 1. In the case of failure to detect incoming packets, action 1 is triggered first and is executed at intervals of one hour until action 2 is due. When action 2 is executed, action 1 gets disabled and thereafter only action 2 is executed every 10 hours until action 3 is due.

If the status of the interface is detected as 'up' at any stage then no subsequent failure action will occur and all failure timers are reset. In the case of any subsequent failure, all failure actions are re-enabled and the action sequence is repeated.

Configuration package used

Package	Sections
cwatch	watch

25.1. Configuring Connection Watch Using The Web Interface

To configure Connection Watch using the web interface, select **Services - >Connection Watch**. The Connection Watch page appears.



The add connection watch configuration page

If no Connection Watch configuration exists in the configuration file, first enter a name for the Connection Watch instance and select **Add**.

Connection Watch

Configuration of Connection Watch.

Watch

WATCH_MOBILE

Enabled

Status **unknown**

Interfaces

- LAN:
- LAN1:
- MOBILE1:
- PPPoADSL:
- loopback:

Failure Time for Action 1:

Failure Action 1:

Failure Grace Time 1: ⓘ Interface activity will be ignored during the grace time

Failure Time for Action 2:

Failure Action 2:

Failure Grace Time 2: ⓘ Interface activity will be ignored during the grace time

Failure Time for Action 3:

Failure Action 3:

Failure Grace Time 3: ⓘ Interface activity will be ignored during the grace time

The connection watch configuration page

Web Field/UCI/Package Option	Description				
Web: Enabled UCI: cwatch.@watch[0].enabled Opt: enabled	Enables a cwatch instance. <table border="1"> <tr> <td>Default: 0</td> <td>Disabled</td> </tr> <tr> <td>1</td> <td>Enabled</td> </tr> </table>	Default: 0	Disabled	1	Enabled
Default: 0	Disabled				
1	Enabled				
Web: Interfaces UCI: cwatch.@watch[0].test_ifaces Opt: test_ifaces	Defines the interface name(s) to monitor. Multiple interfaces are delimited by space separator. Example: option test_ifaces 'WANADSL WANMOBILE' If multiple interfaces are defined the failure action will only be triggered if no traffic is received on all interfaces for the defined period.				
Web: Failure Time for Action 1 UCI: cwatch.@watch[0].failure_time_1 Opt: failure_time_1	Defines a duration to monitor an interface for receive traffic. Duration can be specified in seconds, minutes, hours, days. <table border="1"> <tr> <td>Default</td> <td>1 hour</td> </tr> <tr> <td>Range</td> <td>s; m; h; d;</td> </tr> </table>	Default	1 hour	Range	s; m; h; d;
Default	1 hour				
Range	s; m; h; d;				
Web: Failure Action 1 UCI: cwatch.@watch[0].failure_action_1 Opt: failure_action_1	Defines the failure action associated with failure_time_1. Example to force up interface: option failure_action_1 'ifup wan' <table border="1"> <tr> <td>Default</td> <td>blank</td> </tr> <tr> <td>Range</td> <td></td> </tr> </table>	Default	blank	Range	
Default	blank				
Range					
Web: Failure Grace Time 1 UCI: cwatch.@watch[0].failure_grace_time_1 Opt: failure_grace_time_1	Defines a grace time during which interface activity will be ignored after 'Failure Action 1' is executed. Connection Watch will assume the interface to be down during the grace period and will not reset the failure action timers even if packets are received during this grace time. This can be used to overcome the situation where packets can be received after a failure action even though the interface eventually fails to connect. For example, during a USB restart on a mobile interface, a small amount of packets can be registered as being received while a mobile connection is attempted but fails registration. <table border="1"> <tr> <td>Default: 0</td> <td>No grace time</td> </tr> <tr> <td>Range</td> <td>s; m; h; d;</td> </tr> </table>	Default: 0	No grace time	Range	s; m; h; d;
Default: 0	No grace time				
Range	s; m; h; d;				
Web: Failure Time for Action 2 UCI: cwatch.@watch[0].failure_time_2 Opt: failure_time_2	Defines a second duration to monitor an interface for receive traffic. Duration can be specified in seconds, minutes, hours, days. <table border="1"> <tr> <td>Default</td> <td>10 hours</td> </tr> <tr> <td>Range</td> <td>s; m; h; d;</td> </tr> </table>	Default	10 hours	Range	s; m; h; d;
Default	10 hours				
Range	s; m; h; d;				
Web: Failure Action 2 UCI: cwatch.@watch[0].failure_action_2 Opt: failure_action_2	Defines the failure action associated with failure_time_2. Example to reset usb: option failure_action_1 '/etc/init.d/usb_startup restart' <table border="1"> <tr> <td>Default</td> <td>Blank</td> </tr> <tr> <td>Range</td> <td></td> </tr> </table>	Default	Blank	Range	
Default	Blank				
Range					
Web: Failure Grace Time 2 UCI: cwatch.@watch[0].failure_grace_time_2 Opt: failure_grace_time_2	Defines a grace time during which interface activity will be ignored after 'Failure Action 2' is executed. Connection Watch will assume the interface to be down during the grace period and will not reset the failure action timers even if packets are received during this grace time.				

Web Field/UCI/Package Option	Description				
	<p>This can be used to overcome the situation where packets can be received after a failure action even though the interface eventually fails to connect.</p> <p>For example, during a USB restart on a mobile interface, a small amount of packets can be registered as being received while a mobile connection is attempted but fails registration.</p> <table border="1"> <tr> <td>Default: 0</td> <td>No grace time</td> </tr> <tr> <td>Range</td> <td>s; m; h; d;</td> </tr> </table>	Default: 0	No grace time	Range	s; m; h; d;
Default: 0	No grace time				
Range	s; m; h; d;				
Web: Failure Time for Action 3 UCI: cwatch.@watch[0].failure_time_3 Opt: failure_time_3	<p>Defines a third duration to monitor an interface for receive traffic. Duration can be specified in seconds, minutes, hours, days.</p> <table border="1"> <tr> <td>Default</td> <td>24 hours</td> </tr> <tr> <td>Range</td> <td>s; m; h; d;</td> </tr> </table>	Default	24 hours	Range	s; m; h; d;
Default	24 hours				
Range	s; m; h; d;				
Web: Failure Action 3 UCI: cwatch.@watch[0].failure_action_3 Opt: failure_action_3	<p>Defines the failure action associated with failure_time_3. Example to reset usb: option failure_action_3 'reboot'</p> <table border="1"> <tr> <td>Default</td> <td>Blank</td> </tr> <tr> <td>Range</td> <td></td> </tr> </table>	Default	Blank	Range	
Default	Blank				
Range					
Web: Failure Grace Time 3 UCI: cwatch.@watch[0].failure_grace_time_3 Opt: failure_grace_time_3	<p>Defines a grace time during which interface activity will be ignored after 'Failure Action 3' is executed.</p> <p>Connection Watch will assume the interface to be down during the grace period and will not reset the failure action timers even if packets are received during this grace time.</p> <p>This can be used to overcome the situation where packets can be received after a failure action even though the interface eventually fails to connect.</p> <p>For example, during a USB restart on a mobile interface, a small amount of packets can be registered as being received while a mobile connection is attempted but fails registration.</p> <table border="1"> <tr> <td>Default: 0</td> <td>No grace time</td> </tr> <tr> <td>Range</td> <td>s; m; h; d;</td> </tr> </table>	Default: 0	No grace time	Range	s; m; h; d;
Default: 0	No grace time				
Range	s; m; h; d;				

25.2. Configuring Cwatch Using Command Line

By default, all cwatch instances are named 'watch', the cwatch instance is identified by @watch then the watch position in the package as a number. For example, for the first route in the package using UCI:

```
cwatch.@watch[0]=watch
cwatch.@watch[0].enabled=1
```

Or using package options:

```
config watch
option enabled '1'
```

However, to better identify it, we recommend giving the cwatch instance a name. For example, a watch named 'WATCH_MOBILE' will be cwatch.WATCH_MOBILE.

To define a named cwatch instance using UCI, enter:

```
cwatch.WATCH_MOBILE=watch
cwatch.WATCH_MOBILE.enabled=1
```

To define a named cwatch instance using package options, enter:

```
config watch 'WATCH_MOBILE'
option 'enabled' '1'
```

25.2.1. Cwatch Using UCI

```
root@VA_router:~# uci show cwatch
cwatch.WATCH_MOBILE=watch
cwatch.WATCH_MOBILE.enabled=1
cwatch.WATCH_MOBILE.test_ifaces=wan
cwatch.WATCH_MOBILE.failure_time_1=1h
cwatch.WATCH_MOBILE.failure_action_1=ifup wan
cwatch.WATCH_MOBILE.failure_time_2=10h
cwatch.WATCH_MOBILE.failure_action_2=/etc/init.d/usb_startup restart
cwatch.WATCH_MOBILE.failure_time_3=24h
cwatch.WATCH_MOBILE.failure_action_3=reboot
```

cwatch using package options

```
root@VA_router:~# uci export cwatch
package cwatch

config watch 'WATCH_MOBILE'
option enabled '1'
option test_ifaces wan
option failure_time_1 '1h'
option failure_action_1 'ifup wan'
option failure_grace_time_1 `30s`
option failure_time_2 '10h'
option failure_action_2 '/etc/init.d/usb_startup restart'
option failure_grace_time_2 `2m`
option failure_time_3 '24h'
option failure_action_3 'reboot'
```

25.3. Cwatch Diagnostics

A syslog message will be generated when cwatch starts:

```
cwatch[x]: cwatch configuration OK. Entering main loop...
```

Syslog messages will be generated when the failure action is triggered:

```
cwatch[x]: Watch WATCH_MOBILE executed action 1 grace time [x]
```

```
cwatch[x]: Watch WATCH_MOBILE executed action 2 grace time [x]
```

```
cwatch[x]: Watch WATCH_MOBILE executed action 3 grace time [x]
```

A syslog message will be generated if there is a problem with the configured cwatch instance.

```
cwatch[x]: Watch WATCH_MOBILE test_ifaces not defined. Watch ignored
```

26. Configuring DHCP Server And DNS (Dnsmasq)

Dynamic Host Configuration Protocol (DHCP) server is responsible for assigning IP addresses to hosts. IP addresses can be given out on different interfaces and different subnets. You can manually configure lease time as well as setting static IP to host mappings.

Domain Name Server (DNS) is responsible for resolution of IP addresses to domain names on the internet.

Dnsmasq is the application which controls DHCP and DNS services. Dnsmasq has two sections; one to specify general DHCP and DNS settings and one or more DHCP pools to define DHCP operation on the desired network interface.

Configuration Package Used

Package	Sections
dchp	dnsmasq
	dhcp
	host

26.1. Configuring IPv6 Routes Using The Web Interface

You can also specify IPv6 routes by defining one or more IPv6 routes. In the IPv6 routes section, click **Add**.

Web Field/UCI/Package Option	Description				
Web: Interface UCI: network.@route[1].interface Opt: interface	Specifies the logical interface name of the parent or master interface this route belongs to. It must refer to one of the defined interface sections.				
Web: target UCI: network.@route[1].target Opt: target	Specifies the route network IP address, or subnet in CIDR notation: Example: 2001:0DB8:100:F00:BA3::1/64				
Web: Gateway UCI: network.@route[1].gateway Opt: Gateway	Network gateway. If omitted, the gateway from the parent interface is taken. If set to 0.0.0.0 no gateway will be specified for the route.				
Web: Metric UCI: network.@route[1].metric Opt: metric	Specifies the route metric to use. <table border="1"> <tr> <td>Default</td> <td>0</td> </tr> <tr> <td>Range</td> <td></td> </tr> </table>	Default	0	Range	
Default	0				
Range					
Web: MTU UCI: network.@route[1].mtu Opt: mtu	Defines a specific MTU for this route. If omitted the MTU from the parent interface will be taken. <table border="1"> <tr> <td>Default</td> <td>Empty</td> </tr> <tr> <td>Range</td> <td></td> </tr> </table>	Default	Empty	Range	
Default	Empty				
Range					

When you have made your changes, click **Save & Apply**.

26.2. Configuring DHCP And DNS Using The Web Interface

In the top menu, select **Network -> DHCP and DNS**. The DHCP and DNS page appears.

DHCP and DNS

Dnsmasq is a combined DHCP-Server and DNS-Forwarder for NAT firewalls

Server Settings

General Settings | **Resolve and Hosts Files** | TFTP Settings | Advanced Settings

Domain required [Don't forward DNS-Requests without DNS-Name](#)

Authoritative [This is the only DHCP in the local network](#)

Interfaces [lan:](#) [lan2:](#) [loopback:](#) [wan:](#) [wan1:](#)

[Select interfaces to be served by dnsmasq. If none selected dnsmasq will serve on all interfaces](#)

Local server [Local domain specification. Names matching this domain are never forwarded and resolved from DHCP or hosts files only](#)

Local domain [Local domain suffix appended to DHCP names and hosts file entries](#)

Log queries [Write received DNS requests to syslog](#)

DNS forwardings [List of DNS servers to forward requests to. To forward only specific domain requests use // syntax](#)

Rebind protection [Discard upstream RFC1918 responses](#)

Allow localhost [Allow upstream responses in the 127.0.0.0/8 range, e.g. for RBL services](#)

Domain whitelist [List of domains to allow RFC1918 responses for](#)

Active Leases

Hostname	IPv4-Address	MAC-Address	Leasetime remaining
There are no active leases.			

Static Leases

Static leases are used to assign fixed IP addresses and symbolic hostnames to DHCP clients. They are also required for non-dynamic interface configurations where only hosts with a corresponding lease are served.
Use the **Add** Button to add a new lease entry. The **MAC-Address** identifies the host, the **IPv4-Address** specifies to the fixed address to use and the **Hostname** is assigned as symbolic name to the requesting host.

Hostname	MAC-Address	IPv4-Address
This section contains no values yet		

The DHCP and DNS page

There are three sections: Server Settings, Active Leases, and Static Leases.

26.2.1. Dnsmasq: General Settings

Web Field/UCI/Package Option	Description				
Web: Domain required UCI: dhcp@dnsmasq[0].domainneeded Opt: domainneeded	Defines whether to forward DNS requests without a DNS name. Dnsmasq will never forward queries for plain names, without dots or domain parts, to upstream nameservers. If the name is not known from /etc/hosts or DHCP then a "not found" answer is returned. <table border="1"> <tr> <td>Default: 0</td> <td>Disabled</td> </tr> <tr> <td>1</td> <td>Enabled</td> </tr> </table>	Default: 0	Disabled	1	Enabled
Default: 0	Disabled				
1	Enabled				
Web: Authoritative UCI: dhcp@dnsmasq[0].authoritative Opt: authoritative	Forces authoritative mode. This speeds up DHCP leasing. Used if this is the only server in the network. <table border="1"> <tr> <td>Default: 0</td> <td>Disabled</td> </tr> <tr> <td>1</td> <td>Enabled</td> </tr> </table>	Default: 0	Disabled	1	Enabled
Default: 0	Disabled				
1	Enabled				
Web: Interfaces UCI: dhcp@dnsmasq[0].interface Opt: list interface	Defines the list of interfaces to be served by dnsmasq. If you do not select a specific interface, dnsmasq will serve on all interfaces. Configured interfaces are shown via the web GUI. <table border="1"> <tr> <td>Default</td> <td>Lan. Serve only on LAN interface</td> </tr> <tr> <td>Range</td> <td></td> </tr> </table>	Default	Lan. Serve only on LAN interface	Range	
Default	Lan. Serve only on LAN interface				
Range					
Web: Local Server UCI: dhcp@dnsmasq[0].local Opt: local	Specifies the local domain. Names matching this domain are never forwarded and are resolved from DHCP or host files only. <table border="1"> <tr> <td>Default</td> <td>/lan/</td> </tr> <tr> <td>Range</td> <td></td> </tr> </table>	Default	/lan/	Range	
Default	/lan/				
Range					
Web: Local Domain UCI: dhcp@dnsmasq[0].domain Opt: domain	Specifies local domain suffix appended to DHCP names and hosts file entries. <table border="1"> <tr> <td>Default</td> <td>lan</td> </tr> <tr> <td>Range</td> <td></td> </tr> </table>	Default	lan	Range	
Default	lan				
Range					
Web: Log Queries UCI: dhcp@dnsmasq[0].logqueries Opt: logqueries	Writes received DNS requests to syslog. <table border="1"> <tr> <td>Default: 0</td> <td>Disabled</td> </tr> <tr> <td>1</td> <td>Enabled</td> </tr> </table>	Default: 0	Disabled	1	Enabled
Default: 0	Disabled				
1	Enabled				
Web: DNS Forwardings UCI: dhcp@dnsmasq[0].server Opt: list server	List of DNS servers to forward requests to. To forward specific domain requests only, use // syntax. When using UCI, enter multiple servers with a space between them. <table border="1"> <tr> <td>Default</td> <td>No DNS server configured</td> </tr> <tr> <td>Range</td> <td></td> </tr> </table>	Default	No DNS server configured	Range	
Default	No DNS server configured				
Range					
Web: Rebind Protection UCI: dhcp@dnsmasq[0].rebind_protection Opt: rebind_protection	Enables DNS rebind attack protection by discarding upstream RFC1918 responses. <table border="1"> <tr> <td>Default: 0</td> <td>Disabled</td> </tr> <tr> <td>1</td> <td>Enabled</td> </tr> </table>	Default: 0	Disabled	1	Enabled
Default: 0	Disabled				
1	Enabled				
Web: Allow Localhost UCI: dhcp@dnsmasq[0].rebind_localhost Opt: rebind_localhost	Defines whether to allow upstream responses in the 127.0.0.0/8 range. This is required for DNS-based blacklist services. Only takes effect if rebind protection is enabled. <table border="1"> <tr> <td>Default: 0</td> <td>Disabled</td> </tr> <tr> <td>1</td> <td>Enabled</td> </tr> </table>	Default: 0	Disabled	1	Enabled
Default: 0	Disabled				
1	Enabled				
Web: Domain Whitelist UCI: dhcp@dnsmasq[0].rebind_domain Opt: list rebind_domain	Defines the list of domains to allow RFC1918 responses to. Only takes effect if rebind protection is enabled. When using UCI multiple servers, enter the domains with a space between them. <table border="1"> <tr> <td>Default</td> <td>No list configured</td> </tr> </table>	Default	No list configured		
Default	No list configured				

Web Field/UCI/Package Option	Description
	Range

26.2.2. Dnsmasq: Resolv And Host Files

DHCP and DNS

Dnsmasq is a combined [DHCP-Server](#) and [DNS-Forwarder](#) for NAT firewalls

Server Settings

[General Settings](#) | [Resolv and Hosts Files](#) | [TFTP Settings](#) | [Advanced Settings](#)

Use `/etc/ethers` [Read /etc/ethers to configure the DHCP-Server](#)

Leasefile [file where given DHCP-leases will be stored](#)

Ignore resolve file

Resolve file [local DNS file](#)

Ignore Hosts files

Additional Hosts files

The resolv and host files section

Web Field/UCI/Package Option	Description				
Web: Use <code>/etc/ethers</code> UCI: <code>dhcp@dnsmasq[0].readethers</code> Opt: <code>readethers</code>	Defines whether static lease entries are read from <code>/etc/ethers</code> . <table border="1" style="width: 100%;"> <tr> <td>0</td> <td>Disabled</td> </tr> <tr> <td>Default: 1</td> <td>Enabled</td> </tr> </table>	0	Disabled	Default: 1	Enabled
0	Disabled				
Default: 1	Enabled				
Web: Leasefile UCI: <code>dhcp@dnsmasq[0].leasefile</code> Opt: <code>leasefile</code>	Defines the file where given DHCP leases will be stored. The DHCP lease file allows leases to be picked up again if dnsmasq is restarted. <table border="1" style="width: 100%;"> <tr> <td>Default</td> <td><code>/tmp/dhcp.leases</code></td> </tr> <tr> <td>Range</td> <td><input type="text"/></td> </tr> </table>	Default	<code>/tmp/dhcp.leases</code>	Range	<input type="text"/>
Default	<code>/tmp/dhcp.leases</code>				
Range	<input type="text"/>				
Web: Ignore resolve file UCI: <code>dhcp@dnsmasq[0].noresolv</code> Opt: <code>noresolv</code>	Defines whether to use the local DNS file for resolving DNS. <table border="1" style="width: 100%;"> <tr> <td>Default: 0</td> <td>Use local DNS file</td> </tr> <tr> <td>1</td> <td>Ignore local DNS file</td> </tr> </table>	Default: 0	Use local DNS file	1	Ignore local DNS file
Default: 0	Use local DNS file				
1	Ignore local DNS file				
Web: Resolve file UCI: <code>dhcp@dnsmasq[0].resolvfile</code> Opt: <code>resolvfile</code>	Defines the local DNS file. <table border="1" style="width: 100%;"> <tr> <td>Default</td> <td><code>/tmp/resolv.conf.auto</code></td> </tr> <tr> <td>Range</td> <td><input type="text"/></td> </tr> </table>	Default	<code>/tmp/resolv.conf.auto</code>	Range	<input type="text"/>
Default	<code>/tmp/resolv.conf.auto</code>				
Range	<input type="text"/>				
Web: Ignore Hosts files UCI: <code>dhcp@dnsmasq[0].nohosts</code> Opt: <code>nohosts</code>	Defines whether to use local host's files for resolving DNS. <table border="1" style="width: 100%;"> <tr> <td>Default: 0</td> <td>Use local hosts file</td> </tr> <tr> <td>1</td> <td>Ignore local hosts file</td> </tr> </table>	Default: 0	Use local hosts file	1	Ignore local hosts file
Default: 0	Use local hosts file				
1	Ignore local hosts file				
Web: Additional Hosts files UCI: <code>dhcp@dnsmasq[0].addnhosts</code> Opt: <code>list addnhosts</code>	Defines local host's files. When using UCI multiple servers should be entered with a space between them.				

26.2.3. Dnsmasq: TFTP Settings

DHCP and DNS

Dnsmasq is a combined DHCP-Server and DNS-Forwarder for NAT firewalls

Server Settings

General Settings
Resolv and Hosts Files
TFTP Settings
Advanced Settings

Enable TFTP server

TFTP server root Root directory for files served via TFTP

Network boot image Filename of the boot image advertised to clients

The TFTP settings section

Web Field/UCI/Package Option	Description				
Web: Enable TFTP server UCI: dhcp@dnsmasq[0].enable_tftp Opt: enable_tftp	Enables the TFTP server. <table border="1" style="font-size: x-small; border-collapse: collapse; margin-top: 5px;"> <tr> <td style="padding: 2px;">Default: 0</td> <td style="padding: 2px;">Disabled</td> </tr> <tr> <td style="padding: 2px;">1</td> <td style="padding: 2px;">Enabled</td> </tr> </table>	Default: 0	Disabled	1	Enabled
Default: 0	Disabled				
1	Enabled				
Web: TFTP server Root UCI: dhcp@dnsmasq[0].tftp_root Opt: tftp_root	Defines root directory for file served by TFTP.				
Web: Network boot image UCI: dhcp@dnsmasq[0].dhcp_boot Opt: dhcp_boot	Defines the filename of the boot image advertised to clients. This specifies BOOTP options, in most cases just the file name.				

26.2.4. Dnsmasq: Advanced Settings

DHCP and DNS

Dnsmasq is a combined DHCP-Server and DNS-Forwarder for NAT firewalls

Server Settings

[General Settings](#) [Resolv and Hosts Files](#) [TFTP Settings](#) [Advanced Settings](#)

[Filter private](#) [Do not forward reverse lookups for local networks](#)

[Filter useless](#) [Do not forward requests that cannot be answered by public name servers](#)

[Localise queries](#) [Localise hostname depending on the requesting subnet if multiple IPs are available](#)

[Expand hosts](#) [Add local domain suffix to names served from hosts files](#)

[No negative cache](#) [Do not cache negative replies, e.g. for not existing domains](#)

[Strict order](#) [DNS servers will be queried in the order of the resolvfile](#)

[Bogus NX Domain Override](#) [List of hosts that supply bogus NX domain results](#)

[DNS server port](#) [Listening port for inbound DNS queries](#)

[DNS query port](#) [Fixed source port for outbound DNS queries](#)

[Max. DHCP leases](#) [Maximum allowed number of active DHCP leases](#)

[Max. EDNS0 packet size](#) [Maximum allowed size of EDNS.0 UDP packets](#)

[Max. concurrent queries](#) [Maximum allowed number of concurrent DNS queries](#)

The advanced settings page

Web Field/UCI/Package Option	Description				
Web: Filter private UCI: dhcp@dnsmasq[0]. Opt: boguspriv	Enables disallow option for forwarding reverse lookups for local networks. This rejects reverse lookups to private IP ranges where no corresponding entry exists in /etc/hosts. <table border="1"> <tr> <td>0</td> <td>Disabled</td> </tr> <tr> <td>Default: 1</td> <td>Enabled</td> </tr> </table>	0	Disabled	Default: 1	Enabled
0	Disabled				
Default: 1	Enabled				
Web: Filter useless UCI: dhcp@dnsmasq[0].filterwin2k Opt: filterwin2k	Enables disallow option for forwarding requests that cannot be answered by public name servers. Normally enabled for dial on demand interfaces. <table border="1"> <tr> <td>Default: 0</td> <td>Disabled</td> </tr> <tr> <td>1</td> <td>Enabled</td> </tr> </table>	Default: 0	Disabled	1	Enabled
Default: 0	Disabled				
1	Enabled				
Web: Localise queries UCI: dhcp@dnsmasq[0].localise_queries Opt: localise_queries	Defines whether to use an IP address to match the incoming interface if multiple addresses are assigned to a host name in /etc/hosts.				
Web: Expand hosts UCI: dhcp@dnsmasq[0].expandhosts Opt: expandhosts	Adds a local domain suffix to names served from host files. <table border="1"> <tr> <td>0</td> <td>Disabled</td> </tr> <tr> <td>Default: 1</td> <td>Enabled</td> </tr> </table>	0	Disabled	Default: 1	Enabled
0	Disabled				
Default: 1	Enabled				
Web: No negative cache UCI: dhcp@dnsmasq[0].nonegcache Opt: nonegcache	Enable this to stop caching of negative replies. For example, non-existing domains. <table border="1"> <tr> <td>0</td> <td>Disabled</td> </tr> <tr> <td>1</td> <td>Enabled</td> </tr> </table>	0	Disabled	1	Enabled
0	Disabled				
1	Enabled				
Web: Strict order UCI: dhcp@dnsmasq[0].strictorder Opt: strictorder	Enable this to query DNS servers in the order of the resolve file. <table border="1"> <tr> <td>Default: 0</td> <td>Disabled</td> </tr> <tr> <td>1</td> <td>Enabled</td> </tr> </table>	Default: 0	Disabled	1	Enabled
Default: 0	Disabled				
1	Enabled				
Web: Bogus NX Domain override UCI: dhcp@dnsmasq[0].bogusnxdomain Opt: list bogusnxdomain	A list of hosts that supply bogus NX domain results. When using UCI multiple servers, enter the server names with a space between them. <table border="1"> <tr> <td>Default</td> <td>Empty list</td> </tr> <tr> <td>Range</td> <td>0-65535</td> </tr> </table>	Default	Empty list	Range	0-65535
Default	Empty list				
Range	0-65535				
Web: DNS server port UCI: dhcp@dnsmasq[0].port Opt: port	Listening port for inbound DNS queries. <table border="1"> <tr> <td>Default: 53</td> <td>Set to 0 to disable DNS functionality.</td> </tr> <tr> <td>Range</td> <td>0-65535</td> </tr> </table>	Default: 53	Set to 0 to disable DNS functionality.	Range	0-65535
Default: 53	Set to 0 to disable DNS functionality.				
Range	0-65535				
Web: DNS query port UCI: dhcp@dnsmasq[0].queryport Opt: queryport	Defines fixed source port for outbound DNS queries. <table border="1"> <tr> <td>Default</td> <td>Any</td> </tr> <tr> <td>Range</td> <td>any; 0-65535</td> </tr> </table>	Default	Any	Range	any; 0-65535
Default	Any				
Range	any; 0-65535				
Web: Max DHCP leases UCI: dhcp@dnsmasq[0].dhcpleasemax Opt: dhcpleasemax	Defines the maximum allowed number of active DHCP leases. <table border="1"> <tr> <td>Default</td> <td>unlimited</td> </tr> <tr> <td>Range</td> <td></td> </tr> </table>	Default	unlimited	Range	
Default	unlimited				
Range					
Web: Max EDNS0 packet size UCI: dhcp@dnsmasq[0].ednspacket_max Opt: ednspacket_max	Defines the maximum allowed size of EDNS.0 UDP packets in bytes. <table border="1"> <tr> <td>Default</td> <td>1280 bytes</td> </tr> <tr> <td>Range</td> <td></td> </tr> </table>	Default	1280 bytes	Range	
Default	1280 bytes				
Range					
Web: Max concurrent queries UCI: dhcp@dnsmasq[0].dnsforwardmax Opt: dnsforwardmax	Maximum allowed number of concurrent DNS queries. <table border="1"> <tr> <td>Default: 150</td> <td>1280 bytes</td> </tr> <tr> <td>Range</td> <td></td> </tr> </table>	Default: 150	1280 bytes	Range	
Default: 150	1280 bytes				
Range					

26.2.5. Active Leases

Active Leases

Active Leases

Hostname	IPv4 Address	MAC Address	Leasetime remaining
There are no active leases.			

The active leases section

This section displays all currently active leases.

Web Field/UCI/Package Option	Description
Web: Hostname UCI: n/a Opt: n/a	Displays the hostname of the client.
Web: IPv4 Address UCI: n/a Opt: n/a	Displays the IP address of the client.
Web: MAC Address UCI: n/a Opt: n/a	Displays the MAC address of the client.
Web: Lease time remaining UCI: n/a Opt: n/a	Displays the remaining lease time.

26.2.6. Static Leases: DHCP Server And DNS

Use static leases to assign fixed IP addresses and symbolic hostnames to DHCP clients. Static leases are also required for non-dynamic interface configurations where only hosts with a corresponding lease are served. Click **Add** to add a new lease entry.

Static Leases

Static leases are used to assign fixed IP addresses and symbolic hostnames to DHCP clients. They are also required for non-dynamic interface configurations where only hosts with a corresponding lease are served.
Use the **Add** Button to add a new lease entry. The *MAC-Address* identifies the host, the *IPv4-Address* specifies the fixed address to use and the *Hostname* is assigned as symbolic name to the requesting host.

Hostname	MAC-Address	IPv4-Address
<input type="text"/>	<input type="text"/>	<input type="text"/>

Add **Save & Apply** **Save** **Reset**

The static leases section

Web Field/UCI/Package Option	Description				
Web: Hostname UCI: dhcp@host[0].name Opt: name	Defines the optional symbolic name to assign to this static DHCP entry. <table border="1"> <tr> <td>Default: 0</td> <td>Disabled</td> </tr> <tr> <td>1</td> <td>Enabled</td> </tr> </table>	Default: 0	Disabled	1	Enabled
Default: 0	Disabled				
1	Enabled				
Web: MAC Address UCI: dhcp@host[0].mac Opt: mac	Defines the hardware address that identifies the host.				
Web: IPv4 Address UCI: dhcp@host[0].ip Opt: ip	The IPv4 address specifies the fixed address to use for this host.				

26.2.7. Configuring DHCP Pools Using The Web Interface

DHCP pools are configured via the interface configuration.

Select **Network -> Interfaces**. Choose the interface you want to add the DHCP pool to and select **Edit**. Scroll to **DNCP Server** section.

Note: this section is only available for interfaces with a static IP address. To assign a DHCP Server to the interface, click **Setup DHCP Server**.

DHCP Server

No DHCP Server
configured for this
interface

The DHCP server settings

The DHCP Server configuration options will appear. The DHCP Server is divided into two sub sections: General Setup and Advanced Settings.

DHCP Server

General Setup

Advanced Settings

Ignore interface [Disable DHCP for this interface.](#)

Mode DHCPv4 [Mode of operation](#)

Start 100 [Lowest leased address as offset from the network address.](#)

Limit 150 [Maximum number of leased addresses.](#)

Leasetime 12h [Expiry time of leased addresses, minimum is 2 Minutes \(2m\).](#)

DHCP server advanced settings page

Web Field/UCI/Package Option	Description															
Web: Ignore interface UCI: dhcp@dhcp[x].ignore Opt: ignore	Defines whether the DHCP pool should be enabled for this interface. If not specified for the DHCP pool then the default is disabled i.e. dhcp pool enabled. <table border="1"> <tr> <td>Default: 0</td> <td>Disabled</td> </tr> <tr> <td>1</td> <td>Enabled</td> </tr> </table>	Default: 0	Disabled	1	Enabled											
Default: 0	Disabled															
1	Enabled															
Web: Mode UCI: dhcp@dhcp[x].mode Opt: mode	Defines whether the DHCP pool should be enabled for this interface. If not specified for the DHCP pool then the default is disabled i.e. dhcp pool enabled. <table border="1"> <thead> <tr> <th>Web</th> <th>Description</th> <th>UCI</th> </tr> </thead> <tbody> <tr> <td>Default: DHCPv4</td> <td>DHCP for IPv4</td> <td>ipv4</td> </tr> <tr> <td>DHCPv6</td> <td>DHCP for IPv6</td> <td>ipv6_dhcp</td> </tr> <tr> <td>IPv6 Router Advertisements</td> <td>IPv6 RA</td> <td>ipv6_ra</td> </tr> <tr> <td>DHCPv6 Prefix Delegation</td> <td>DHCPv6 prefix delegation</td> <td>ipv6_pd</td> </tr> </tbody> </table>	Web	Description	UCI	Default: DHCPv4	DHCP for IPv4	ipv4	DHCPv6	DHCP for IPv6	ipv6_dhcp	IPv6 Router Advertisements	IPv6 RA	ipv6_ra	DHCPv6 Prefix Delegation	DHCPv6 prefix delegation	ipv6_pd
Web	Description	UCI														
Default: DHCPv4	DHCP for IPv4	ipv4														
DHCPv6	DHCP for IPv6	ipv6_dhcp														
IPv6 Router Advertisements	IPv6 RA	ipv6_ra														
DHCPv6 Prefix Delegation	DHCPv6 prefix delegation	ipv6_pd														
Web: Start UCI: dhcp@dhcp[x].start Opt: start	Defines the offset from the network address for the start of the DHCP pool. Example: for network address 192.168.100.10/24, start=100, DHCP allocation pool will start at 192.168.100.100. For subnets greater than /24, it may be greater than 255 to span subnets. Alternatively, specify in IP address notation using the wildcard '0' where the octet is required to inherit bits from the interface IP address. Example: to define a DHCP scope starting from 10.1.20.0 on an interface with 10.1.0.0/16 address, set start to 0.0.20.1 <table border="1"> <tr> <td>Default</td> <td>100</td> </tr> <tr> <td>Range</td> <td></td> </tr> </table>	Default	100	Range												
Default	100															
Range																
Web: Limit UCI: dhcp@dhcp[x].limit Opt: limit	Defines the size of the address pool. Example: For network address 192.168.100.10/24, start=100, limit=150, DHCP allocation pool will be .100 to .249 <table border="1"> <tr> <td>Default: 150</td> <td>Limits DHCP allocation pool to 50 available addresses</td> </tr> <tr> <td>Range</td> <td>0-255</td> </tr> </table>	Default: 150	Limits DHCP allocation pool to 50 available addresses	Range	0-255											
Default: 150	Limits DHCP allocation pool to 50 available addresses															
Range	0-255															
Web: Leasetime UCI: dhcp@dhcp[x].leasetime Opt: leasetime	Defines the lease time of addresses handed out to clients, for example 12h or 30m. <table border="1"> <tr> <td>Default</td> <td>12 hours</td> </tr> <tr> <td>Range</td> <td></td> </tr> </table>	Default	12 hours	Range												
Default	12 hours															
Range																
Web: n/a UCI: dhcp@dhcp[x].interface Opt: interface	Defines the interface that is served by this DHCP pool. This must be one of the configured interfaces. When configured through the web UI this will be automatically populated with the interface name.															

DHCP Server: Advanced Settings

DHCP Server

[General Setup](#) [Advanced Settings](#)

Dynamic DHCP Dynamically allocate DHCP addresses for clients. If disabled, only clients having static leases will be served.

Force Force DHCP on this network even if another server is detected.

IPv4-Netmask Override the netmask sent to clients. Normally it is calculated from the subnet that is served.

DHCP-Options Define additional DHCP options, for example "6,192.168.2.1,192.168.2.2" which advertises different DNS servers to clients.

The DHCP server advanced settings section

Web Field/UCI/Package Option	Description				
Web: Dynamic DHCP UCI: dhcp@dhcp[x].dynamicdhcp Opt: dynamicdhcp	Defines whether to dynamically allocate DHCP leases. <table border="1" style="margin-top: 10px;"> <tr> <td>Default 1</td> <td>Dynamically allocate leases</td> </tr> <tr> <td>0</td> <td>Use /etc/ethers file for serving DHCP leases</td> </tr> </table>	Default 1	Dynamically allocate leases	0	Use /etc/ethers file for serving DHCP leases
Default 1	Dynamically allocate leases				
0	Use /etc/ethers file for serving DHCP leases				
Web: Force UCI: dhcp@dhcp[x].force Opt: force	Forces DHCP serving on the specified interface even if another DHCP server is detected on the same network segment. <table border="1" style="margin-top: 10px;"> <tr> <td>0</td> <td>Disabled</td> </tr> <tr> <td>1</td> <td>Enabled</td> </tr> </table>	0	Disabled	1	Enabled
0	Disabled				
1	Enabled				
Web: IPv4-Netmask UCI: dhcp@dhcp[x].netmask Opt: netmask	Defines a netmask sent to clients that overrides the netmask as calculated from the interface subnet. <table border="1" style="margin-top: 10px;"> <tr> <td>Default</td> <td>Use netmask from interface subnet</td> </tr> <tr> <td>Range</td> <td></td> </tr> </table>	Default	Use netmask from interface subnet	Range	
Default	Use netmask from interface subnet				
Range					
Web: DHCP-Options UCI: dhcp@dhcp[x].dhcp_option Opt: list dhcp_option	Defines additional options to be added for this dhcp pool. <p>For example, with 'list dhcp_option 26,1470' or 'list dhcp_option mtu, 1470' you can assign a specific MTU per DHCP pool. Your client must accept the MTU option for this to work. Options that contain multiple values should be separated by a comma.</p> <p>Example: list dhcp_option 6,192.168.2.1,192.168.2.2</p> <table border="1" style="margin-top: 10px;"> <tr> <td>Default</td> <td>No options defined</td> </tr> <tr> <td>Syntax</td> <td>Option_number, option_value</td> </tr> </table>	Default	No options defined	Syntax	Option_number, option_value
Default	No options defined				
Syntax	Option_number, option_value				
Web: n/a UCI: dhcp@dhcp[x].networkid Opt: networkid	Assigns a network-id to all clients that obtain an IP address from this pool. <table border="1" style="margin-top: 10px;"> <tr> <td>Default</td> <td>Use network from interface subnet</td> </tr> <tr> <td>Range</td> <td></td> </tr> </table>	Default	Use network from interface subnet	Range	
Default	Use network from interface subnet				
Range					

26.3. Configuring DHCP And DNS Using Command Line

Possible section types of the DHCP configuration file include Common Options (dnsmasq), DHCP Pools (dhcp) and Static Leases (host). Not all types may appear in the file and most of them are only needed for special configurations.

The configuration section type **dnsmasq** determines values and options relevant to the overall operation of dnsmasq and the DHCP options on all interfaces served.

26.3.1. Configuring Static Leases Using Command Line

Static leases are configured under the **dhcp** package, stored at **/etc/config/dhcp**. By default, all static leases instances are named **host**. The static lease is identified by **@host** then the static lease position in the package as a number. For example, for the first static lease in the package using UCI:

```
dhcp.@host[0]=dhcp
dhcp.@host[0].name=mypc
```

Or using package options:

```
config host
option name 'mypc'
```

However, to better identify, it is recommended to give the static lease instance a name. For example, to create a static instance named **mypc**.

To define a named static lease instance using UCI, enter:

```
dhcp.mypc=host
dhcp.mypc.name=mypc
```

To define a named static lease instance using package options, enter:

```
config dhcp 'mypc'
option name 'mypc'
```

The following examples using UCI and package options add the fixed IP address 192.168.1.2 and the name "mypc" for a machine with the (Ethernet) hardware address 00:11:22:33:44:55.

Example of Static Leases using UCI

```
root@VA_router:~# uci show dhcp.mypc
dhcp.mypc=host
dhcp.mypc.ip=192.168.1.2
dhcp.mypc.mac=00:11:22:33:44:55
dhcp.mypc.name=mypc
```

Example of Static Leases using Package Options

```
root@VA_router:~# uci export dhcp package dhcp
####
config host 'mypc'
option ip '192.168.1.2'
option mac '00:11:22:33:44:55'
option name 'mypc'
```

26.3.2. Configuring DHCP Pools Using Command Line

DHCP pools are configured under the **dhcp** package, stored at **/etc/config/dhcp**.

Sections of the type **dhcp** specify per interface lease pools and settings. Typically, there is at least one section of this type present in the `/etc/config/dhcp` file to cover the LAN interface.

You can disable a lease pool for a specific interface by specifying the `ignore` option in the corresponding section.

You can configure multiple dhcp pools.

By default, all dhcp pool instances are named 'dhcp'. The instance is identified by `@dhcp` then the dhcp pool position in the package as a number. For example, for the first dhcp pool in the package using UCI:

```
dhcp.@dhcp[0]=dhcp
dhcp.@dhcp[0].interface=LAN
```

Or using package options:

```
config dhcp
option interface 'LAN'
```

However, to better identify, it is recommended to give the dhcp pool instance a name. For example, to create a dhcp pool instance named LAN.

To define a named dhcp pool instance using UCI, enter:

```
dhcp.LAN=dhcp
dhcp.LAN.interface=LAN
```

To define a named dhcp pool instance using package options, enter:

```
config dhcp 'LAN'
option interface 'LAN'
```

Configuring DHCP pools using UCI

```
root@VA_router:~# uci show dhcp.LAN
dhcp.LAN=dhcp
dhcp.LAN.interface=lan
dhcp.LAN.start=100
dhcp.LAN.limit=150
dhcp.LAN.leaseTime=12h
dhcp.LAN.ignore=0
```

Configuring DHCP pools using package options

```
root@VA_router:~# uci export dhcp
package dhcp
:::
config 'dhcp' 'LAN'
option 'interface' 'LAN' option 'start' '100' option 'limit' '150' option 'leaseTime' '12h' option ignore 0
```

27. Configuring DHCP Client

This section describes how to configure an interface as a DHCP client. This section will only detail the configuration for DHCP client. For information on how to configure other interface options such as firewall zone, mapping of switch ports, etc, read the standard interface configuration document.

Configuration Packages Used

Package	Sections
Network	interface

27.1. Configuring DHCP Client Using The Web Interface

DHCP client is configured under the interface configuration by setting the interface protocol to DHCP Client. To create and edit interfaces via the web interface, in the top menu, click **Network -> Interfaces**. The Interfaces overview page appears.

The screenshot shows the 'Interfaces' overview page in the Merlin 4400 web interface. At the top, there is a navigation bar with 'Status', 'System', 'Services', 'Network', and 'Logout'. A dropdown menu is open over the 'Network' menu item, listing various network services: Interfaces, DHCP and DNS, Hostnames, Static Routes, Diagnostics, Firewall, Port-based VLAN, ADSL, RIP, Multi-WAN, VRRP, BGP, OSPF, DHCP-Forwarder, and DMVPN. The main content area is titled 'Interfaces' and 'Interface Overview'. It contains a table with the following data:

Network	Status	Actions
3G_S1_VODA 3g-3g_s1_voda	RX: 0.00 B (0 Pkts.) TX: 0.00 B (0 Pkts.)	Connect Stop Edit Delete
LAN eth0	Uptime: 0h 15m 1s MAC Address: 00:00:00:00:00:00 RX: 2.47 MB (3065 Pkts.) TX: 496.73 KB (13 Pkts.) IPv4: 10.1.9.88/16	Connect Stop Edit Delete
LAN1 eth1	Uptime: 0h 0m 0s MAC Address: 00:00:00:00:00:00 RX: 0.00 B (0 Pkts.) TX: 0.00 B (0 Pkts.)	Connect Stop Edit Delete
LOOPBACK lo	Uptime: 0h 0m 0s MAC Address: 00:00:00:00:00:00 RX: 0.00 B (0 Pkts.) TX: 0.00 B (0 Pkts.) IPv6: 0:0:0:0:0:0:1/128	Connect Stop Edit Delete
WAN 3g-wan	RX: 0.00 B (0 Pkts.) TX: 0.00 B (0 Pkts.)	Connect Stop Edit Delete
WAN1 3g-wan1	RX: 0.00 B (0 Pkts.) TX: 0.00 B (0 Pkts.)	Connect Stop Edit Delete
WAN2 3g-wan2	RX: 0.00 B (0 Pkts.) TX: 0.00 B (0 Pkts.)	Connect Stop Edit Delete

Below the table is an 'Add new interface...' button. The 'Port Map' section includes a description: 'Map device ports to ethernet interfaces. Ports are marked with capital letters starting with 'A'. Type in space separated port numbers to fields below'. It has two input fields: 'eth0' with 'A' and 'eth1' with 'B'. The 'ATM Bridges' section has a description: 'ATM bridges expose encapsulated ethernet in AAL5 connections as virtual Linux network interfaces which can be used in conjunction with DHCP or PPP to dial into the provider network. This section contains no values yet' and an 'Add' button. At the bottom right, there are 'Save & Apply', 'Save', and 'Reset' buttons.

The interfaces overview page

There are three sections in the Interfaces page.

Section	Description
Interface Overview	Shows existing interfaces and their status. You can create new, and edit existing interfaces here.
Port Map	In this section you can map device ports to Ethernet interfaces. Ports are marked with capital letters starting with 'A'. Type in space-separated port character in the port map fields.
ATM Bridges	ATM bridges expose encapsulated Ethernet in AAL5 connections as virtual Linux network interfaces, which can be used in conjunction with DHCP or PPP to dial into the provider network.

Edit an Existing Interface for DHCP Client

To edit an existing interface, from the interface tabs at the top of the page, select the interface you wish to configure. Alternatively, click **Edit** in the interface's row.

27.1.1. Creating A New Interface For DHCP Client

To create a new interface, in the Interface Overview section, click **Add new interface**. The Create Interface page appears.

Create Interface

Name of the new interface: The allowed characters are: A-Z, a-z, 0-9 and _

Protocol of the new interface:

Create a bridge over multiple interfaces:

Cover the following interface:

- Ethernet Adapter: "eth0"
- Ethernet Adapter: "eth1" (lan2)
- Ethernet Adapter: "eth2"
- Ethernet Adapter: "eth3"
- Ethernet Adapter: "eth4"
- Ethernet Adapter: "eth5"
- Ethernet Adapter: "eth6"
- Ethernet Adapter: "eth7"
- Ethernet Adapter: "lo" (loopback)
- Ethernet Adapter: "teq10"
- Ethernet Adapter: "tun10"
- Custom Interface:

Note: If you select an interface in this menu which is already a part of another network, it will be moved from that network to this network.

The create interface page

Web Field/UCI/Package Option	Description																																							
Web: Name of the new interface UCI: network.<if name> Opt: config interface	Assigns a logical name to the interface. The network interface section will assign this name (<if name>). Type the name of the new interface. Allowed characters are A-Z, a-z, 0-9 and _																																							
Web: Protocol of the new interface UCI: network.<if name>.proto Opt: proto	Specifies what protocol the interface will operate on. Select DHCP Client . <table border="1"> <thead> <tr> <th>Option</th> <th>Description</th> <th>UCI</th> </tr> </thead> <tbody> <tr> <td>Static</td> <td>static configuration with fixed address and netmask.</td> <td>static</td> </tr> <tr> <td>DHCP Client</td> <td>Address and netmask are assigned by DHCP</td> <td>dhcp</td> </tr> <tr> <td>Unmanaged</td> <td>Unspecified</td> <td>Empty</td> </tr> <tr> <td>IPv6-inIPv4 (RFC4213)</td> <td>Used with tunnel brokers</td> <td></td> </tr> <tr> <td>IPv6-over-IPv4</td> <td>Stateless IPv6 over IPv4 transport</td> <td></td> </tr> <tr> <td>GRE</td> <td>Generic Routing Encapsulation protocol</td> <td></td> </tr> <tr> <td>IOT</td> <td></td> <td></td> </tr> <tr> <td>L2TP</td> <td>Layer 2 Tunnelling Protocol</td> <td></td> </tr> <tr> <td>PPP</td> <td>Point to Point Protocol</td> <td></td> </tr> <tr> <td>PPPoE</td> <td>PPP over Ethernet</td> <td></td> </tr> <tr> <td>PPPoATM</td> <td>PPP over ATM</td> <td></td> </tr> <tr> <td>LTE/UMTS/GPRS/EV-DO</td> <td>CDMA, UMTS or GPRS connection using an AT-style 3G modem</td> <td></td> </tr> </tbody> </table>	Option	Description	UCI	Static	static configuration with fixed address and netmask.	static	DHCP Client	Address and netmask are assigned by DHCP	dhcp	Unmanaged	Unspecified	Empty	IPv6-inIPv4 (RFC4213)	Used with tunnel brokers		IPv6-over-IPv4	Stateless IPv6 over IPv4 transport		GRE	Generic Routing Encapsulation protocol		IOT			L2TP	Layer 2 Tunnelling Protocol		PPP	Point to Point Protocol		PPPoE	PPP over Ethernet		PPPoATM	PPP over ATM		LTE/UMTS/GPRS/EV-DO	CDMA, UMTS or GPRS connection using an AT-style 3G modem	
Option	Description	UCI																																						
Static	static configuration with fixed address and netmask.	static																																						
DHCP Client	Address and netmask are assigned by DHCP	dhcp																																						
Unmanaged	Unspecified	Empty																																						
IPv6-inIPv4 (RFC4213)	Used with tunnel brokers																																							
IPv6-over-IPv4	Stateless IPv6 over IPv4 transport																																							
GRE	Generic Routing Encapsulation protocol																																							
IOT																																								
L2TP	Layer 2 Tunnelling Protocol																																							
PPP	Point to Point Protocol																																							
PPPoE	PPP over Ethernet																																							
PPPoATM	PPP over ATM																																							
LTE/UMTS/GPRS/EV-DO	CDMA, UMTS or GPRS connection using an AT-style 3G modem																																							
Web: Create a bridge over multiple interfaces UCI: network.<if name>.type Opt: type	If you select this option, then the new logical interface created will act as a bridging interface between the chosen existing physical interfaces. <table border="1"> <tbody> <tr> <td>Default</td> <td>Empty</td> </tr> <tr> <td>Bridge</td> <td>Configures a bridge over multiple interfaces</td> </tr> </tbody> </table>	Default	Empty	Bridge	Configures a bridge over multiple interfaces																																			
Default	Empty																																							
Bridge	Configures a bridge over multiple interfaces																																							
Web: Cover the following interface UCI: network.<if name>.ifname Opt: ifname	Physical interface name to assign to this logical interface. If creating a bridge over multiple interfaces select two interfaces to bridge. When using UCI, the interface names should be separated by a space e.g. option ifname 'eth2 eth3'.																																							

Click **Submit**. The Interface configuration page appears. There are three sections:

Section	Description
Common Configuration	Configure the interface settings such as protocol, IP address, gateway, netmask, custom DNS servers, MTU and firewall configuration.
IP-Aliases	Assign multiple IP addresses to the interface.
DHCP Server	Configure DHCP server settings for this interface.

27.2. Common Configuration

The Common Configuration section has four sub-sections.

Section	Description
General Setup	Configure the basic interface settings such as protocol, IP address, gateway, netmask, custom DNS servers.
Advanced Settings	'Bring up on boot', 'Monitor interface state', Override MAC address, Override MTU and 'Use gateway metric'.
Physical Settings	Bridge interfaces, VLAN PCP to SKB priority mapping.
Firewall settings	Assign a firewall zone to the interface.

Only General Setup and Advanced Settings have DHCP client option configuration options.

27.2.1. Common Configuration: General Setup

Common Configuration

General Setup Advanced Settings Physical Settings Firewall Settings

Status  eth3 MAC Address: 00:E0:C8:D3:18:20
RX: 0.00 B (0 Pkts.)
TX: 0.00 B (0 Pkts.)

Protocol: DHCP client

Hostname to send when requesting DHCP: VA_router

Accept router advertisements:

Send router solicitations:

The interface general setup configuration page for DHCP client protocol

Web Field/UCI/Package Option	Description																																							
Web: Status	Shows the current status of the interface.																																							
Web: Protocol UCI: network.<if name>.proto Opt: proto	<p>Protocol type. The interface protocol may be one of the options shown below. The protocol selected in the previous step will be displayed as default but can be changed if required.</p> <p>Select DHCP Client.</p> <table border="1"> <thead> <tr> <th>Option</th> <th>Description</th> <th>UCI</th> </tr> </thead> <tbody> <tr> <td>Static</td> <td>static configuration with fixed address and netmask</td> <td>static</td> </tr> <tr> <td>DHCP Client</td> <td>Address and netmask are assigned by DHCP</td> <td>dhcp</td> </tr> <tr> <td>Unmanaged</td> <td>Unspecified</td> <td>Empty</td> </tr> <tr> <td>IPv6-inIPv4 (RFC4213)</td> <td>Used with tunnel brokers</td> <td></td> </tr> <tr> <td>IPv6-over-IPv4</td> <td>Stateless IPv6 over IPv4 transport</td> <td></td> </tr> <tr> <td>GRE</td> <td>Generic Routing Encapsulation protocol</td> <td></td> </tr> <tr> <td>IOT</td> <td></td> <td></td> </tr> <tr> <td>L2TP</td> <td>Layer 2 Tunnelling Protocol</td> <td></td> </tr> <tr> <td>PPP</td> <td>Point to Point Protocol</td> <td></td> </tr> <tr> <td>PPPoE</td> <td>PPP over Ethernet</td> <td></td> </tr> <tr> <td>PPPoATM</td> <td>PPP over ATM</td> <td></td> </tr> <tr> <td>LTE/UMTS/GPRS/EV-DO</td> <td>CDMA, UMTS or GPRS connection using an AT-style 3G modem</td> <td></td> </tr> </tbody> </table>	Option	Description	UCI	Static	static configuration with fixed address and netmask	static	DHCP Client	Address and netmask are assigned by DHCP	dhcp	Unmanaged	Unspecified	Empty	IPv6-inIPv4 (RFC4213)	Used with tunnel brokers		IPv6-over-IPv4	Stateless IPv6 over IPv4 transport		GRE	Generic Routing Encapsulation protocol		IOT			L2TP	Layer 2 Tunnelling Protocol		PPP	Point to Point Protocol		PPPoE	PPP over Ethernet		PPPoATM	PPP over ATM		LTE/UMTS/GPRS/EV-DO	CDMA, UMTS or GPRS connection using an AT-style 3G modem	
Option	Description	UCI																																						
Static	static configuration with fixed address and netmask	static																																						
DHCP Client	Address and netmask are assigned by DHCP	dhcp																																						
Unmanaged	Unspecified	Empty																																						
IPv6-inIPv4 (RFC4213)	Used with tunnel brokers																																							
IPv6-over-IPv4	Stateless IPv6 over IPv4 transport																																							
GRE	Generic Routing Encapsulation protocol																																							
IOT																																								
L2TP	Layer 2 Tunnelling Protocol																																							
PPP	Point to Point Protocol																																							
PPPoE	PPP over Ethernet																																							
PPPoATM	PPP over ATM																																							
LTE/UMTS/GPRS/EV-DO	CDMA, UMTS or GPRS connection using an AT-style 3G modem																																							
Web: Hostname to send when requesting DHCP UCI: network.<if name>.hostname Opt: hostname	Defines the hostname to include in DHCP requests																																							
Web: Accept router advertisements UCI: network.<if name>.accept_ra Opt: accept_ra	<p>Specifies whether to accept IPv6 Router Advertisements on this interface (optional).</p> <p>Note: default is 1 if protocol is set to DHCP, otherwise the setting defaults to 0.</p> <table border="1"> <tbody> <tr> <td>0</td> <td>Does not accept IPv6 router advertisements</td> </tr> <tr> <td>Default</td> <td>Accepts IPv6 router advertisements</td> </tr> </tbody> </table>	0	Does not accept IPv6 router advertisements	Default	Accepts IPv6 router advertisements																																			
0	Does not accept IPv6 router advertisements																																							
Default	Accepts IPv6 router advertisements																																							
Web: Send router solicitations UCI: network.<if name>.send_rs Opt: send_rs	<p>Specifies whether to send router solicitations on this interface (optional).</p> <p>Note: defaults to 1 for static protocol, otherwise the setting defaults to 0.</p> <table border="1"> <tbody> <tr> <td>Default 0</td> <td>Does not send router solicitations</td> </tr> <tr> <td>1</td> <td>Sends router solicitations</td> </tr> </tbody> </table>	Default 0	Does not send router solicitations	1	Sends router solicitations																																			
Default 0	Does not send router solicitations																																							
1	Sends router solicitations																																							

27.2.2. Common Configuration: Advanced Settings

Common Configuration

[General Setup](#) **Advanced Settings** [Physical Settings](#) [Firewall Settings](#)

Bring up on boot

Monitor interface state ⓘ *This interface state would be reported to VA Monitor via keep-alive*

Use broadcast flag ⓘ *Required for certain ISPs, e.g. Charter with DOCSIS 3*

Use default gateway ⓘ *If unchecked, no default route is configured*

Use DNS servers advertised by peer ⓘ *If unchecked, the advertised DNS server addresses are ignored*

Use gateway metric

Client ID to send when requesting DHCP

Vendor Class to send when requesting DHCP

Override MAC address

Override MTU

Dependant interfaces ADSL: ⓘ LAN3: ⓘ

The interface advanced settings page for DHCP client protocol

Web Field/UCI/Package Option	Description				
Web: Bring up on boot UCI: network.<if name>.auto Opt: auto	Enables the interface to connect automatically on boot up. <table border="1"> <tr> <td>0</td> <td>Disabled</td> </tr> <tr> <td>1</td> <td>Enabled</td> </tr> </table>	0	Disabled	1	Enabled
0	Disabled				
1	Enabled				
Web: Monitor interface state UCI: network.<if name>.monitored Opt: monitored	Enabled if the status of the interface is presented on the monitoring platform. <table border="1"> <tr> <td>0</td> <td>Disabled</td> </tr> <tr> <td>1</td> <td>Enabled</td> </tr> </table>	0	Disabled	1	Enabled
0	Disabled				
1	Enabled				
Web: Use broadcast flag UCI: network.<if name>.broadcast Opt: broadcast	Enables the broadcast flag in DHCP requests (required for certain ISPs). <table border="1"> <tr> <td>0</td> <td>Disabled</td> </tr> <tr> <td>1</td> <td>Enabled</td> </tr> </table>	0	Disabled	1	Enabled
0	Disabled				
1	Enabled				
Web: Use default gateway UCI: network.<if name>.gateway Opt: gateway	Defines whether to suppress the DHCP assigned default gateway. When disabled via web option, the gateway is set to 0.0.0.0. <table border="1"> <tr> <td>0</td> <td>Disabled</td> </tr> <tr> <td>1</td> <td>Enabled</td> </tr> </table>	0	Disabled	1	Enabled
0	Disabled				
1	Enabled				
Web: Use DNS servers advertised by peer UCI: n/a Opt: n/a	Defines whether to override DHCP assigned DNS servers with configured list of DNS servers. When unchecked allows configuration of custom DNS servers via web. There is no uci option set when checking or unchecking this option.				
Web: Use custom DNS servers UCI: network.<if name>.dns Opt: dns	Defines whether to override DHCP assigned DNS servers with configured list of DNS servers. Multiple DNS Servers are separated by a space if using UCI. Example: option dns '1.1.1.1 2.2.2.2' <table border="1"> <tr> <td>Default. 0</td> <td>Disabled. (option gateway set to 0.0.0.0)</td> </tr> <tr> <td>1</td> <td>Enabled</td> </tr> </table>	Default. 0	Disabled. (option gateway set to 0.0.0.0)	1	Enabled
Default. 0	Disabled. (option gateway set to 0.0.0.0)				
1	Enabled				
Web: Use gateway metric UCI: network.<if name>.metric Opt: metric	Specifies the default route metric to use for this interface. <table border="1"> <tr> <td>Default. 0</td> <td>Disabled</td> </tr> <tr> <td>Range</td> <td></td> </tr> </table>	Default. 0	Disabled	Range	
Default. 0	Disabled				
Range					
Web: Client ID to send when requesting DHCP UCI: network.< name>.clientid Opt: clientid	Defines whether to override the client identifier in DHCP requests. <table border="1"> <tr> <td>Default</td> <td>Blank. Do not override</td> </tr> <tr> <td>Range</td> <td>Override</td> </tr> </table>	Default	Blank. Do not override	Range	Override
Default	Blank. Do not override				
Range	Override				
Web: Vendor Class to send when requesting DHCP UCI: network.<name>.vendorid Opt: vendorid	Defines whether to override the vendor class in DHCP requests <table border="1"> <tr> <td>Default</td> <td>Blank. Do not override</td> </tr> <tr> <td>Range</td> <td>Override</td> </tr> </table>	Default	Blank. Do not override	Range	Override
Default	Blank. Do not override				
Range	Override				
Web: Override MAC address UCI: network.< name>.macaddr Opt: macaddr	Overrides the MAC address assigned to this interface. Must be in the form: hh:hh:hh:hh:hh:hh, where h is a hexadecimal number.				
Web: Override MTU UCI: network.<name>.mtu Opt: mtu	Defines the value to override the default MTU on this interface. 1500 1500 bytes <table border="1"> <tr> <td>Default</td> <td>1500 bytes</td> </tr> </table>	Default	1500 bytes		
Default	1500 bytes				
Web: Dependant Interfaces UCI: network.[if_name].dependants	Lists interfaces that are dependant on this parent interface. Dependant interfaces will go down when the parent interface is down and will start or restart when the parent interface starts.				

Web Field/UCI/Package Option	Description										
Opt: dependants	<p>Separate multiple interfaces by a space when using UCI. Example: option dependants 'PPPADSL MOBILE'</p> <p>This replaces the following previous options in child interfaces.</p> <table border="1"> <tr> <td>gre</td> <td>option local_interface</td> </tr> <tr> <td>lt2p</td> <td>option src_ipaddr</td> </tr> <tr> <td>iot</td> <td>option wan1 wan2</td> </tr> <tr> <td>6in4</td> <td>option ipaddr</td> </tr> <tr> <td>6to4</td> <td>option ipaddr</td> </tr> </table>	gre	option local_interface	lt2p	option src_ipaddr	iot	option wan1 wan2	6in4	option ipaddr	6to4	option ipaddr
gre	option local_interface										
lt2p	option src_ipaddr										
iot	option wan1 wan2										
6in4	option ipaddr										
6to4	option ipaddr										
Web: SNMP Alias ifIndex UCI: network.@interface[X].snmp_alias_ifindex Opt: snmp_alias_ifindex	<p>Defines a static SNMP interface alias index for this interface, that can be polled using via the SNMP interface index (snmp_alias_ifindex+1000)</p> <table border="1"> <tr> <td>Blank</td> <td>No SNMP interface alias index</td> </tr> <tr> <td>1</td> <td>Enabled</td> </tr> </table>	Blank	No SNMP interface alias index	1	Enabled						
Blank	No SNMP interface alias index										
1	Enabled										

27.3. Configuring DHCP Client Using Command Line

The configuration files for DHCP client are stored on **/etc/config/network**

DHCP Client using UCI

```

root@VA_router:~# uci show network
network.DHCPCLIENTLAN=interface
network.DHCPCLIENTLAN,proto=dhcp
network.DHCPCLIENTLAN.ifname=eth3
network.DHCPCLIENTLAN.monitored=0
network.DHCPCLIENTLAN.broadcast=0
network.DHCPCLIENTLAN.accept_ra=1
network.DHCPCLIENTLAN.send_rs=0
network.DHCPCLIENTLAN.metric=1

```

DHCP client using Package Options

```

root@VA_router:~# uci export network package network
config interface 'DHCPCLIENTLAN'
option proto 'dhcp'
option ifname 'eth3'
option monitored '0'
option broadcast '0'
option accept_ra '1'
option send_rs '0'
option metric '1'

```

27.4. DHCP Client Diagnostics

Interface Status

To view the IP address of DHCP client interface, enter:

```
3g-CDMA Link encap:Point-to-Point Protocol
inet addr:10.33.152.100 P-t-P:178.72.0.237 Mask:255.255.255.255
UP POINTOPOINT RUNNING NOARP MULTICAST MTU:1400 Metric:1
RX packets:6 errors:0 dropped:0 overruns:0 frame:0
TX packets:23 errors:0 dropped:0 overruns:0 carrier:0
collisions:0 txqueuelen:3
RX bytes:428 (428.0 B) TX bytes:2986 (2.9 KiB)

eth0 Link encap:Ethernet HWaddr 00:E0:C8:12:12:15
inet addr:192.168.100.1 Bcast:192.168.100.255
Mask:255.255.255.0
inet6 addr: fe80::2e0:c8ff:fe12:1215/64 Scope:Link
```

```
UP BROADCAST RUNNING MULTICAST MTU:1500 Metric:1
RX packets:6645 errors:0 dropped:0 overruns:0 frame:0 TX packets:523 errors:0 dropped:0 overruns:0 carrier:0 collisions:0
txqueuelen:1000
RX bytes:569453 (556.1 KiB) TX bytes:77306 (75.4 KiB)

lo Link encap:Local Loopback
inet addr:127.0.0.1 Mask:255.0.0.0 inet6 addr: ::1/128 Scope:Host
UP LOOPBACK RUNNING MTU:16436 Metric:1
RX packets:385585 errors:0 dropped:0 overruns:0 frame:0 TX packets:385585 errors:0 dropped:0 overruns:0 carrier:0 collisions:0
txqueuelen:0
RX bytes:43205140 (41.2 MiB) TX bytes:43205140 (41.2 MiB)
```

To display a specific interface, enter:

```
root@VA_router:~# ifconfig eth0
eth0 Link encap:Ethernet HWaddr 00:E0:C8:12:12:15 inet addr:192.168.100.1 Bcast:192.168.100.255
Mask:255.255.255.0
inet6 addr: fe80::2e0:c8ff:fe12:1215/64 Scope:Link UP BROADCAST RUNNING MULTICAST MTU:1500 Metric:1
RX packets:7710 errors:0 dropped:0 overruns:0 frame:0 TX packets:535 errors:0 dropped:0 overruns:0 carrier:0 collisions:0
txqueuelen:1000
RX bytes:647933 (632.7 KiB) TX bytes:80978 (79.0 KiB)
```

ARP Table Status

```
root@VA_router:~# arp
? (10.67.253.141) at 30:30:41:30:43:36 [ether] on eth8
? (10.47.48.1) at 0a:44:b2:06 [ether] on gre-gre1
```

Route Status

```
root@VA_router:~# route -n
```

Kernel IP routing table

Destination	Gateway	Genmask	Flags	Metric	Ref	Use	Iface
192.168.100.0	*	255.255.255.0	U	0	0	0	eth0



NOTE

A route will only be displayed in the routing table when the interface is up.

28. Configuring DHCP Forwarding

This section describes how to configure the router to forward DHCP requests from an interface to a network DHCP server.

Configuration Packages Used

Package	Sections
dhcp_fwd	dhcpfwd

28.1. Configuring DHCP Using The Web Interface

To configure DHCP forwarding using the web interface, in the top menu, click **Network -> DHCP-Forwarder**.

The DHCP forwarder page appears. The web GUI creates a dhcpfwd section called main so this will be used in the uci examples below.

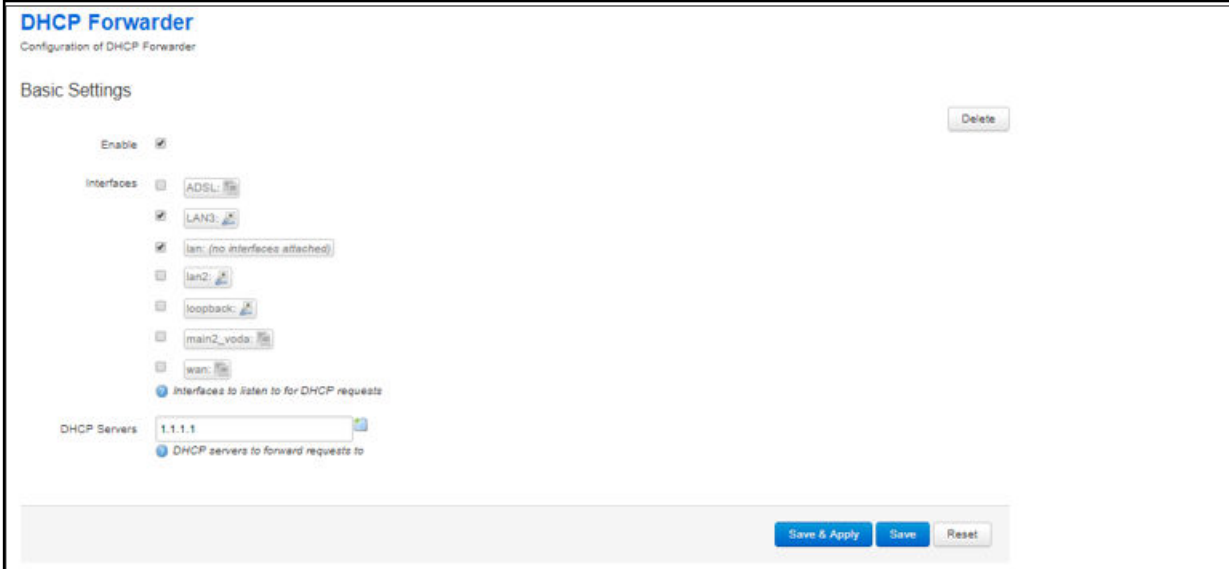

The screenshot shows the 'DHCP Forwarder' configuration page. The title is 'DHCP Forwarder' with the subtitle 'Configuration of DHCP Forwarder'. Under 'Basic Settings', there is a 'Delete' button. The 'Enable' checkbox is checked. The 'Interfaces' section lists several interfaces: ADSL, LAN3 (checked), lan: (no interfaces attached) (checked), lan2, loopback, main2_voda, and wan. Below this is a note 'Interfaces to listen to for DHCP requests'. The 'DHCP Servers' field contains '1.1.1.1' and a note 'DHCP servers to forward requests to'. At the bottom, there are three buttons: 'Save & Apply', 'Save', and 'Reset'.

The DHCP forwarder configuration page

Web Field/UCI/Package Option	Description				
Web: Enabled UCI: dhcp_fwd.main.enabled Opt: enabled	<p>Defines whether DHCP forwarding is enabled or disabled.</p> <table border="1"> <tr> <td>Default: 0</td> <td>Do not send router solicitations</td> </tr> <tr> <td>1</td> <td>Send router solicitations</td> </tr> </table>	Default: 0	Do not send router solicitations	1	Send router solicitations
Default: 0	Do not send router solicitations				
1	Send router solicitations				
Web: Interfaces UCI: dhcp_fwd.main.listen_interface Opt: list listen_interface	<p>Defines a list of the source interface name(s) to forward DHCP messages from.</p> <p>Multiple interface_name(s) are entered using uci set and uci add_list commands.</p> <p>Example:</p> <pre>uci set dhcp_fwd.main.listen_interface=LAN1 uci add_list dhcp_fwd.main.listen_interface=LAN2</pre> <p>or using a list of options via package options</p> <pre>list listen_interface 'LAN1' list listen_interface 'LAN2'</pre>				
Web: DHCP Servers UCI: dhcp_fwd.main.server Opt: list server	<p>Defines a list of the network DHCP servers to forward DHCP messages to.</p> <p>Multiple interface_name(s) are entered using uci set and uci add_list commands.</p> <p>Example:</p> <pre>uci set dhcp_fwd.main.server=1.1.1.1 uci add_list dhcp_fwd.main.main.server=2.2.2.2</pre> <p>or using a list of options via package options</p> <pre>list server '1.1.1.1' list server '2.2.2.2'</pre>				

28.2. Configuring DHCP Forwarding Using Command Line

The configuration files for DHCP client are stored in `/etc/config/dhcp_fwd`

DHCP Forwarding using UCI

```
root@VA_router:~# uci show
dhcp_fwd dhcp_fwd.main=dhcpfwd
dhcp_fwd.main.enabled=1
dhcp_fwd.main.listen_interface=LAN3 lan2
dhcp_fwd.main.server=1.1.1.1
```

DHCP Forwarding using Package Options

```
root@VA_router:~# uci export dhcp_fwd
package dhcp_fwd
config dhcpfwd 'main'
option enabled '1'
list listen_interface 'lan2'
list server '1.1.1.1'
```

28.3. DHCP Forwarding Over IPsec

DHCP messages are forwarded over the WAN interface using the IP address of the WAN interface as the source IP for the transmitted packet. This means that when forwarding over an IPsec tunnel a source NAT firewall rule is required to change the source IP to match an IPsec connection rule.

Package	Sections
firewall	redirect

28.3.1. Configuring Source NAT For DHCP Forwarding Over IPsec

To enter a source NAT rule, browse to **Network -> Firewall**. Select **Traffic Rules** tab. The Firewall - Traffic Rules page appears.

Configure a source NAT rule that changes the source IP for UDP destination port 67 from the required LAN.

For more information on configuring a source NAT rule, read the 'Configuring Firewall' chapter of this manual.

Source NAT
Source NAT is a specific form of masquerading which allows fine grained control over the source IP used for outgoing traffic, for example to map multiple WAN addresses to internal subnets.

Name	Protocol	Source	Destination	SNAT	Enable	Sort
<i>This section contains no values yet</i>						

New source NAT:

Name	Source zone	Destination zone	To source IP	To source port	
DHCPMessages	lan ▼	wan ▼	192.168.100.1	Do not rewrite	Add and edit...

Save & Apply
Save
Reset

The firewall > traffic rules configuration page

Web Field/UCI/Package Option	Description
Web: Name UCI: firewall.@redirect[X].name Opt: name	Defines a name for the source NAT rule.
Web: Source Zone UCI: firewall.@redirect[X].src Opt: src	Defines the source interface for the source NAT rule. Select the interface where the DHCP requests are originating .
Web: Destination Zone UCI: firewall.@redirect[X].dest Opt: dest	Defines destination interface for the source NAT rule. Select the interface where the DHCP requests are intended to be transmitted .
Web: To source IP UCI: firewall.@redirect[X].src_dip Opt: src_dip	Defines the IP address to rewrite matched traffic souce IP. Select the source IP address to match the required IPsec rule .
Web: To source port UCI: firewall.@redirect[X].src_dport Opt: src_dport	Defines the port number to rewrite matched traffic souce port number. Leave empty.

Firewall - Traffic Rules - SNAT DHCPMessages

This page allows you to change advanced properties of the traffic rule entry, such as matched source and destination hosts.

Rule is enabled

Name:

Protocol: ⓘ You may specify multiple by selecting "-- custom --" and then entering protocols separated by space.

Source zone: lan: lan: lan2: ⓘ wan: main2_voda: ⓘ wan: ⓘ

Source MAC address:

Source IP address:

Source port: ⓘ Match incoming traffic originating from the given source port or port range on the client host.

Destination zone: lan: lan: lan2: ⓘ wan: main2_voda: ⓘ wan: ⓘ

Destination IP address:

Destination port: ⓘ Match forwarded traffic to the given destination port or port range.

SNAT IP address: ⓘ Rewrite matched traffic to the given address.

SNAT port: ⓘ Rewrite matched traffic to the given source port. May be left empty to only rewrite the IP address.

Extra arguments: ⓘ Passes additional arguments to iptables. Use with care!

The firewall > traffic rules > SNAT configuration page

Web Field/UCI/Package Option	Description																					
Web: Rule is enabled UCI: firewall.@redirect[X].enabled Opt: enabled	Defines whether source NAT rule is enabled. <table border="1"> <tr> <td>Default: 0</td> <td>Disabled</td> </tr> <tr> <td>1</td> <td>Enabled</td> </tr> </table>	Default: 0	Disabled	1	Enabled																	
Default: 0	Disabled																					
1	Enabled																					
Web: Name UCI: firewall.@redirect[X].name Opt: name	Defines a name for the source NAT rule.																					
Web: Protocol UCI: firewall.@redirect[X].proto Opt: proto	Defines the protocol for the source NAT rule to match. Select UDP . <table border="1"> <thead> <tr> <th>Option</th> <th>Description</th> <th>UCI</th> </tr> </thead> <tbody> <tr> <td>All protocols</td> <td>Match all protocols</td> <td>all</td> </tr> <tr> <td>TCP+UDP</td> <td>Match TCP and UCP protocols</td> <td>tcp upd</td> </tr> <tr> <td>TCP</td> <td>Match TCP protocol</td> <td>tcp</td> </tr> <tr> <td>UCP</td> <td>Match UDP protocol</td> <td>udp</td> </tr> <tr> <td>ICMP</td> <td>Match ICMP protocol</td> <td>icmp</td> </tr> <tr> <td>Custom</td> <td>Enter custom protocol</td> <td></td> </tr> </tbody> </table>	Option	Description	UCI	All protocols	Match all protocols	all	TCP+UDP	Match TCP and UCP protocols	tcp upd	TCP	Match TCP protocol	tcp	UCP	Match UDP protocol	udp	ICMP	Match ICMP protocol	icmp	Custom	Enter custom protocol	
Option	Description	UCI																				
All protocols	Match all protocols	all																				
TCP+UDP	Match TCP and UCP protocols	tcp upd																				
TCP	Match TCP protocol	tcp																				
UCP	Match UDP protocol	udp																				
ICMP	Match ICMP protocol	icmp																				
Custom	Enter custom protocol																					
Web: Source Zone UCI: firewall.@redirect[X].src Opt: src	Defines the source interface for the source NAT rule. Select the interface where the DHCP requests are originating .																					
Web: Destination Zone UCI: firewall.@redirect[X].dest Opt: dest	Defines destination interface for the source NAT rule. Select the interface where the DHCP requests are intended to be transmitted .																					
Web: Destination port UCI: firewall.@redirect[X].port Opt: port	Defines the destination port number to match. Select 67 .																					
Web: SNAT IP address UCI: firewall.@redirect[X].src_dip Opt: src_dip	Defines the IP address to rewrite matched traffic. Select the source IP address to match the required IPsec rule .																					

28.4. Configuring Source NAT For DHCP Forwarding Over IPsec

To enter a source NAT rule, browse to **Network -> Firewall**. Select **Traffic Rules** tab. The Firewall - Traffic Rules page appears.

Configure a source NAT rule that changes the source IP for UDP destination port 67 from the required LAN.

For more information on configuring a source NAT rule, read the 'Configuring Firewall' chapter of this manual.

Source NAT
 Source NAT is a specific form of masquerading which allows fine grained control over the source IP used for outgoing traffic, for example to map multiple WAN addresses to internal subnets.

Name	Protocol	Source	Destination	SNAT	Enable	Sort
This section contains no values yet!						

New source NAT:

Name	Source zone	Destination zone	To source IP	To source port
DHCPMessages	lan	wan	192.168.100.1	Do not rewrite

Save & Apply Save Reset

The firewall > traffic rules configuration page

Web Field/UCI/Package Option	Description
Web: Name UCI: firewall.@redirect[X].name Opt: name	Defines a name for the source NAT rule.
Web: Source Zone UCI: firewall.@redirect[X].src Opt: src	Defines the source interface for the source NAT rule. Select the interface where the DHCP requests are originating
Web: Destination Zone UCI: firewall.@redirect[X].dest Opt: dest	Defines destination interface for the source NAT rule. Select the interface where the DHCP requests are intended to be transmitted.
Web: To source IP UCI: firewall.@redirect[X].src_dip Opt: src_dip	Defines the IP address to rewrite matched traffic souce IP. Select the source IP address to match the required IPsec rule.
Web: To source port UCI: firewall.@redirect[X].src_dport Opt: src_dport	Defines the port number to rewrite matched traffic souce port number. Leave empty.

Firewall - Traffic Rules - SNAT DHCPMessages

This page allows you to change advanced properties of the traffic rule entry, such as matched source and destination hosts.

Rule is enabled:

Name:

Protocol: ⓘ You may specify multiple by selecting "-- custom --" and then entering protocols separated by space.

Source zone: lan: lan: lan2: wan: main2_voda: wan:

Source MAC address:

Source IP address:

Source port: ⓘ Match incoming traffic originating from the given source port or port range on the client host.

Destination zone: lan: lan: lan2: wan: main2_voda: wan:

Destination IP address:

Destination port: ⓘ Match forwarded traffic to the given destination port or port range.

SNAT IP address: ⓘ Rewrite matched traffic to the given address.

SNAT port: ⓘ Rewrite matched traffic to the given source port. May be left empty to only rewrite the IP address.

Extra arguments: ⓘ Passes additional arguments to iptables. Use with care!

The firewall > traffic rules > SNAT configuration page

Web Field/UCI/Package Option	Description																					
Web: Rule is enabled UCI: firewall.@redirect[X].enabled Opt: enabled	Defines whether source NAT rule is enabled. <table border="1"> <tr> <td>Default: 0</td> <td>Disabled</td> </tr> <tr> <td>1</td> <td>Enabled</td> </tr> </table>	Default: 0	Disabled	1	Enabled																	
Default: 0	Disabled																					
1	Enabled																					
Web: Name UCI: firewall.@redirect[X].name Opt: name	Defines a name for the source NAT rule.																					
Web: Protocol UCI: firewall.@redirect[X].proto Opt: proto	Defines the protocol for the source NAT rule to match. Select UDP . <table border="1"> <thead> <tr> <th>Option</th> <th>Description</th> <th>UCI</th> </tr> </thead> <tbody> <tr> <td>All protocols</td> <td>Match all protocols</td> <td>all</td> </tr> <tr> <td>TCP+UDP</td> <td>Match TCP and UCP protocols</td> <td>tcp upd</td> </tr> <tr> <td>TCP</td> <td>Match TCP protocol</td> <td>tcp</td> </tr> <tr> <td>UCP</td> <td>Match UDP protocol</td> <td>udp</td> </tr> <tr> <td>ICMP</td> <td>Match ICMP protocol</td> <td>icmp</td> </tr> <tr> <td>Custom</td> <td>Enter custom protocol</td> <td></td> </tr> </tbody> </table>	Option	Description	UCI	All protocols	Match all protocols	all	TCP+UDP	Match TCP and UCP protocols	tcp upd	TCP	Match TCP protocol	tcp	UCP	Match UDP protocol	udp	ICMP	Match ICMP protocol	icmp	Custom	Enter custom protocol	
Option	Description	UCI																				
All protocols	Match all protocols	all																				
TCP+UDP	Match TCP and UCP protocols	tcp upd																				
TCP	Match TCP protocol	tcp																				
UCP	Match UDP protocol	udp																				
ICMP	Match ICMP protocol	icmp																				
Custom	Enter custom protocol																					
Web: Source Zone UCI: firewall.@redirect[X].src Opt: src	Defines the source interface for the source NAT rule. Select the interface where the DHCP requests are originating .																					
Web: Destination Zone UCI: firewall.@redirect[X].dest Opt: dest	Defines destination interface for the source NAT rule. Select the interface where the DHCP requests are intended to be transmitted .																					
Web: Destination port UCI: firewall.@redirect[X].port Opt: port	Defines the destination port number to match. Select 67 .																					
Web: SNAT IP address UCI: firewall.@redirect[X].src_dip Opt: src_dip	Defines the IP address to rewrite matched traffic. Select the source IP address to match the required IPsec rule .																					

28.5. Configuring Source NAT For DHCP Forwarding Over IPsec Using Command Line

Source NAT for DHCP Forwarding over IPsec using UCI

```
root@VA_router:~# uci show firewall
#####
firewall.@redirect[0]=redirect
firewall.@redirect[0].target=SNAT
firewall.@redirect[0].src=lan
firewall.@redirect[0].dest=wan
firewall.@redirect[0].src_dip=192.168.100.1
firewall.@redirect[0].name=DHCPMessages
firewall.@redirect[0].proto=udp
firewall.@redirect[0].dest_port=67
```

Source NAT for DHCP Forwarding over IPsec using Package Options

```
root@VA_router:~# uci export firewall
package firewall
#####
config redirect
option target 'SNAT'
option src 'lan'
option dest 'wan'
option src_dip '192.168.100.1'
option name 'DHCPMessages'
option proto 'udp'
option dest_port '67'
```

28.6. DHCP Forwarding Diagnostics

Tracing DHCP Packets

To trace DHCP packets on any interface on the router, enter:

```
root@VA_router:~# tcpdump -i any -n -p port 67 &
root@VA_router:~# tcpdump: verbose output suppressed, use -v or -vv for full protocol decode
listening on any, link-type LINUX_SLL (Linux cooked), capture size 65535 bytes
16:39:20.666070 IP 0.0.0.0.68 > 255.255.255.255.67: BOOTP/DHCP, Request
from 00:e0:c8:13:02:3d, length 360
16:39:20.666166 IP 0.0.0.0.68 > 255.255.255.255.67: BOOTP/DHCP, Request
from 00:e0:c8:13:02:3d, length 360
```

To stop tracing enter **fg** (to bring tracing task to foreground), and then **<CTRL-C>** to stop the trace.

```
root@VA_router:~# fg
tcpdump -i any -n -p port 67
^C
33 packets captured
33 packets received by filter
0 packets dropped by kernel
```

```
16:39:20.666166 IP 0.0.0.68 > 255.255.255.255.67: BOOTP/DHCP, Request
from 00:e0:c8:13:02:3d, length 360
```

ARP Table Status

To show the current ARP table of the router, enter **arp**

```
root@VA_router:~# arp
? (10.67.253.141) at 30:30:41:30:43:36 [ether] on eth8
? (10.47.48.1) at 0a:44:b2:06 [ether] on gre-gre1
```

29. Configuring Dynamic DNS

Dynamic DNS (DDNS) functionality on a Merlin router will dynamically perform DDNS updates to a server so it can associate an IP address with a correctly associated DNS name. Users can then contact a machine, router, device and so on with a DNS name rather than a dynamic IP address.

An account is required with the provider, and one or more domain names are associated with that account. A dynamic DNS client on the router monitors the public IP address associated with an interface and whenever the IP address changes, the client notifies the DNS provider to update the corresponding domain name.

When the DNS provider responds to queries for the domain name, it sets a low lifetime, typically a minute or two at most, on the response so that it is not cached. Updates to the domain name are thus visible throughout the whole internet with little delay.



NOTE

Most providers impose restrictions on how updates are handled: updating when no change of address occurred is considered abusive and may result in an account being blocked. Sometimes, addresses must be refreshed periodically, for example, once a month, to show that they are still in active use.

Configuration Packages Used

Package	Sections
ddns	service

29.1. Configuring Dynamic DNS Using The Web Interface

In the top menu, select **Services** -> **Dynamic DNS**. The Dynamic DNS configuration page appears.

The Dynamic DNS configuration page

Enter a name that will be used for the dynamic DNS section in the configuration. Select Add. The Dynamic DNS configuration options appear.

Dynamic DNS Settings

Dynamic DNS

Dynamic DNS allows that your router can be reached with a fixed hostname while having a dynamically changing IP address.

DDNS1

Enable

Service

Custom update-URL

Hostname

Username

Password

Source of IP address

Network

Check for changed IP every

Check-time unit

Force update every

Force-time unit

Listen on

The Dynamic DNS main settings page

Web Field/UCI/Package Option	Description						
Web: Enabled UCI: <code>ddns.<name>.enabled</code> Opt: <code>enabled</code>	Enables a dynamic DNS entry on the router <table border="1"> <tr> <td>0. Default</td> <td>Disabled</td> </tr> <tr> <td>1</td> <td>Enabled</td> </tr> </table>	0. Default	Disabled	1	Enabled		
0. Default	Disabled						
1	Enabled						
Web: Service UCI: <code>ddns.<name>.service_name</code> Opt: <code>service_name</code>	Defines the dynamic DNS provider.						
Web: Customer update-URL UCI: <code>ddns.<name>.update_url</code> Opt: <code>update_url</code>	Defines the customer DNS provider. Displayed when the service is set to custom in the web interface.						
Web: Hostname UCI: <code>ddns.<name>.domain</code> Opt: <code>domain</code>	Defines the fully qualified domain name associated with this entry. This is the name to update with the new IP address as needed.						
Web: Password UCI: <code>ddns.<name>.password</code> Opt: <code>password</code>	Defines the password to use for authenticating domain name updates with the selected provider.						
Web: Source of IP address UCI: <code>ddns.<name>.ip_source</code> Opt: <code>ip_source</code>	Defines the type of interface whose IP needs to be updated. <table border="1"> <tr> <td>network</td> <td>IP is associated with a network configuration.</td> </tr> <tr> <td>interface</td> <td>IP is associated with an interface.</td> </tr> <tr> <td>web</td> <td>IP is associated with a URL.</td> </tr> </table>	network	IP is associated with a network configuration.	interface	IP is associated with an interface.	web	IP is associated with a URL.
network	IP is associated with a network configuration.						
interface	IP is associated with an interface.						
web	IP is associated with a URL.						
Web: Network UCI: <code>ddns.<name>ip_network</code> Opt: <code>ip_network</code>	Defines the network whose IP needs to be updated. Displayed when the Source of IP address option is set to network. All the configured network interfaces will be shown.						
Web: Interface UCI: <code>ddns.<name>.ip_interface</code> Opt: <code>ip_interface</code>	Defines the interface whose IP needs to be updated. Displayed when the Source of IP address option is set to interface. All the configured interfaces will be shown.						
Web: URL UCI: <code>ddns.<name>.ip_url</code> Opt: <code>ip_url</code>	Defines the URL where the IP downloaded from. Displayed when the Source of IP address option is set to URL.						
Web: Check for changed IP every UCI: <code>ddns.<name>.check_interval</code> Opt: <code>check_interval</code>	Defines how often to check for an IP change. Used in conjunction with <code>check_unit</code> . <table border="1"> <tr> <td>Default</td> <td>10</td> </tr> <tr> <td>Range</td> <td></td> </tr> </table>	Default	10	Range			
Default	10						
Range							
Web: Check-time unit UCI: <code>ddns.<name>.check_unit</code> Opt: <code>check_unit</code>	Defines the time unit to use for check for an IP change. Used in conjunction with <code>check_interval</code> . <table border="1"> <tr> <td>Default</td> <td>72</td> </tr> <tr> <td>Range</td> <td>Enabled</td> </tr> </table>	Default	72	Range	Enabled		
Default	72						
Range	Enabled						
Web: Force update every UCI: <code>ddns.<name>.force_interval</code> Opt: <code>force_interval</code>	Defines how often to force an IP update to the provider. Used in conjunction with <code>force_unit</code> . <table border="1"> <tr> <td>Default</td> <td>72. Disabled</td> </tr> <tr> <td>Range</td> <td>Enabled</td> </tr> </table>	Default	72. Disabled	Range	Enabled		
Default	72. Disabled						
Range	Enabled						

Web Field/UCI/Package Option	Description				
Web: Force-time unit UCI: <code>ddns.<name>.force_unit</code> Opt: <code>force_unit</code>	Defines the time unit to use for check for an IP change. Used in conjunction with <code>force_interval</code> . <table border="1"> <tr> <td>Default</td> <td>Hours</td> </tr> <tr> <td>Range</td> <td>Minutes-hours</td> </tr> </table>	Default	Hours	Range	Minutes-hours
Default	Hours				
Range	Minutes-hours				
Web: Listen on UCI: <code>ddns.<name>.interface</code> Opt: <code>interface</code>	Defines the interface for ddns monitoring. Typically, this will be the same as the interface whose IP is being updated – as defined <code>ip_network</code> or <code>ip_interface</code> . All configured interfaces will be displayed.				

29.2. Dynamic DNS Using UCI

Dynamic DNS uses the `ddns` package `/etc/config/ddns`

UCI Commands for DDNS

```

root@VA_router:~# uci show ddns
ddns.ddns1=service
ddns.ddns1.enabled=1
ddns.ddns1.service_name=dyndns.org
ddns.ddns1.domain=fqdn_of_interface
ddns.ddns1.username=testusername
ddns.ddns1.password=testpassword
ddns.ddns1.ip_source=network
ddns.ddns1.ip_network=dsl0
ddns.ddns1.check_interval=10
ddns.ddns1.check_unit=minutes
ddns.ddns1.force_interval=72
ddns.ddns1.force_unit=hours
ddns.ddns1.interface=dsl0

```

Package Options for DDNS

```
root@VA_router:~# uci export ddns
package ddns

config service 'ddns1'
option enabled '1'
option service_name 'dyndns.org'
option domain 'fqdn_of_interface'
option username 'test'
option password 'test'
option ip_source 'network'
option ip_network 'dsl0'
option check_interval '10'
option check_unit 'minutes'
option force_interval '72'
option force_unit 'hours'
option interface 'dsl0'
```

30. Configuring Host Names

Hostnames are human-readable names that identify a device connected to a network. There are several different ways in which hostnames can be configured and used on the router.

- Local host file records
- PTR records
- Static DHCP leases

Local Host File Records

The hosts file is an operating system that maps hostnames to IP addresses. It is used preferentially to other name resolution methods such as DNS.

The hosts file contains lines of text consisting of an IP address in the first text field followed by one or more host names. Each field is separated by white space; tabs are often preferred for historical reasons, but spaces are also used. Comment lines may be included; they are indicated by an octothorpe (#) in the first position of such lines. Entirely blank lines in the file are ignored.

By default, the router's local host file contains:

```
127.0.0.1 localhost
::1 ip6-localhost ip6-loopback
```

The local host file is stored at `/etc/hosts`

Configuration Packages Used

Packages	Sections
network	host

30.1. Configuring Local Host Files Entries Using The Web Interface

In the top menu, select **Network -> Interfaces**. The Interfaces configuration page appears.

Browse to **Host Records** section at the bottom of the page.



The host records page

Select **Add**. Enter a hostname and IP address and select **Save & Apply**.

Host Records

Hostname	IP-Address
Hostname1	1.1.1.1

The hosts records configuration page

Web Field/UCI/Package Option	Description
Web: Hostname UCI: network.host.hostname Opt: hostname	Defines the hostname.
Web: IP-Address UCI: network.host.addr Opt: addr	

30.2. Local Host Records Using Command Line

Local host records are configured in the host section of the network package

/etc/config/network.

You can configure multiple hosts.

By default, all host instances are named host and are identified by @host then the host position in the package as a number. For example, for the first host in the package using UCI:

```
network.@host[0]=host
network.@host[0].hostname=Device1
```

Or using package options:

```
config host
option hostname 'Device1'
```

Local Host Records using UCI

```
root@VA_router:~# uci show network
network.@host[0]=host
network.@host[0].hostname=Device1
network.@host[0].addr=1.1.1.1
```

Local Host Records using Package Options

```

root@VA_router:~# uci export network package network
#####
config host
option hostname 'Device1'
option addr '1.1.1.1'

```

30.3. Local Host Records Diagnostics

Hosts Files

Local host records are written to the local hosts file stored at **/etc/hosts**. To view the local hosts file, enter:

```

root@VA_router:~# cat /etc/hosts
127.0.0.1 localhost
::1 ip6-localhost ip6-loopback
1.1.1.1 Device1

```

30.4. Configuring PTR Records Using The Web Interface

PTR records are used for reverse DNS.

The primary purpose for DNS is to map domains to IP addresses. A pointer record works in the opposite way; it associates an IP address with a domain name.

Configuration Packages Used

Package	Sections
dhcp	domain

In the top menu, select **Network -> Hostnames**. The Hostnames configuration page appears.

Hostnames

Host entries

Hostname	IP address
<i>This section contains no values yet</i>	

The hostnames entries page

Select **Add**. Enter a hostname and IP address for the PTR record and select **Save & Apply**.

Hostnames

Host entries

Hostname	IP address	
<input type="text" value="Domain1"/>	<input type="text" value="2.2.2.2"/>	<input type="button" value="Delete"/>
<input type="button" value="Add"/>		

The hostnames configuration page

30.5. PTR Records Using Command Line

PTR records are configured in the **domain** section of the dhcp package.

/etc/config/dhcp.

Multiple **domains** can be configured.

By default, all domain instances are named domain and are identified by @domain then the domain position in the package as a number. For example, for the first domain in the package using UCI:

```

dhcp.@domain[0]=domain
dhcp.@domain[0].name=Domain1
```

Or using package options:

```

config domain
option name 'Domain1'
```

PTR Records using UCI

```

root@VA_router:~# uci show dhcp
###
dhcp.@domain[0]=domain
dhcp.@domain[0].name=Domain1
dhcp.@domain[0].ip=2.2.2.2
```

PTR Records using Package Options

```

root@VA_router:~# uci export dhcp package dhcp
###
config domain
option name 'Domain1'
option ip '2.2.2.2'
```

30.6. PTR Records Diagnostics

PTR Records Table

To view PTR records, enter:

```
root@VA_router:~# pgrep -fl dnsmasq
4724 /usr/sbin/dnsmasq -K -D -y -Z -b -E -s lan -S /lan/ -l
/tmp/dhcp.leases -r /tmp/resolv.conf.auto --stop-dns-rebind --rebind-
localhost-ok -A /Device1.lan/1.1.1.1 --ptr-record=1.1.1.1.in-
addr.arpa,Device1.lan -A /Device2.lan/2.2.2.2 --ptr-record=2.2.2.2.in-
addr.arpa,Device2.lan
```

30.7. Configuring Static Leases Using The Web Interface

Static leases are used to assign fixed IP addresses and symbolic hostnames to DHCP clients based on the MAC (hardware) address.

They are also required for non dynamic interface configurations where only hosts with a corresponding lease are served.

Package	Sections
dhcp	host

In the top menu, select **Network -> DHCP and DNS**. The DHCP and DNS configuration page appears.

Browse to **Static leases** section.

Static Leases

Static leases are used to assign fixed IP addresses and symbolic hostnames to DHCP clients. They are also required for non-dynamic interface configurations where only hosts with a corresponding lease are served.
Use the *Add* Button to add a new lease entry. The *MAC-Address* identifies the host, the *IPv4-Address* specifies to the fixed address to use and the *Hostname* is assigned as symbolic name to the requesting host.

Hostname	MAC-Address	IPv4-Address
This section contains no values yet		

The static leases add page

Select **Add**. Enter a hostname, MAC address and IP address for the static lease. Select **Save & Apply**.

Static Leases

Static leases are used to assign fixed IP addresses and symbolic hostnames to DHCP clients. They are also required for non-dynamic interface configurations where only hosts with a corresponding lease are served.
Use the *Add* Button to add a new lease entry. The *MAC-Address* identifies the host, the *IPv4-Address* specifies to the fixed address to use and the *Hostname* is assigned as symbolic name to the requesting host.

Hostname	MAC-Address	IPv4-Address	
<input type="text" value="host1"/>	<input type="text" value="aa.bb.cc.dd:ee.ff"/>	<input type="text" value="4.4.4.4"/>	<input type="button" value="Delete"/>

The static leases configuration page

Web Field/UCI/Package Option	Description
Web: Hostname UCI: dhcp.host.name Opt: name	Defines the symbolic hostname to assign.
Web: MAC-Address UCI: dhcp.host.mac Opt: mac	Defines the MAC address for this host. MAC addresses should be entered in the format aa:bb:cc:dd:ee:ff
Web: IPv4-Address UCI: dhcp.host.ip Opt: ip	Defines the IP address to be used for this host.

30.8. Configuring Static Leases Using Command Line

Static leases are configured under the **dhcp** package, stored at **/etc/config/dhcp**. By default, all static leases instances are named **host**. The static lease is identified by **@host** then the static lease position in the package as a number. For example, for the first static lease in the package using UCI:

```
dhcp.@host[0]=dhcp
dhcp.@host[0].name=mypc
```

Or using package options:

```
config host
option name 'mypc'
```

However, to better identify, it is recommended to give the static lease instance a name. For example, to create a static instance named **mypc**.

To define a named static lease instance using UCI, enter:

```
dhcp.mypc=host
dhcp.mypc.name=mypc
```

To define a named static lease instance using package options, enter:

```
config dhcp 'mypc'
option name 'mypc'
```

The following examples using UCI and package options add the fixed IP address 192.168.1.2 and the name "mypc" for a machine with the (Ethernet) hardware address 00:11:22:33:44:55.

Example of Static Leases using UCI

```
root@VA_router:~# uci show dhcp.mypc
dhcp.mypc=host
dhcp.mypc.ip=192.168.1.2
dhcp.mypc.mac=00:11:22:33:44:55
dhcp.mypc.name=mypc
```

Example of Static Leases using Package Options

```
root@VA_router:~# uci export dhcp package dhcp
■■■■
config host 'mypc'
option ip '192.168.1.2'
option mac '00:11:22:33:44:55'
option name 'mypc'
```

31. Configuring Firewall

The firewall itself is not required. It is a set of scripts which configure Netfilter. If preferred, you can use Netfilter directly to achieve the desired firewall behaviour.



NOTE

The UCI firewall exists to simplify configuring Netfilter for many scenarios, without requiring the knowledge to deal with the complexity of Netfilter.

The firewall configuration consists of several zones covering one or more interfaces. Permitted traffic flow between the zones is controlled by forwardings. Each zone can include multiple rules and redirects (port forwarding rules).

The Netfilter system is a chained processing filter where packets pass through various rules. The first rule that matches is executed often leading to another rule-chain until a packet hits either ACCEPT or DROP/REJECT.

Accepted packets pass through the firewall. Dropped packets are prohibited from passing. Rejected packets are also prohibited but an ICMP message is returned to the source host.

A minimal firewall configuration for a router usually consists of one 'defaults' section, at least two 'zones' (LAN and WAN) and one forwarding to allow traffic from LAN to WAN. Other sections that exist are 'redirects', 'rules' and 'includes'.

Configuration Package Used

Package	Sections
firewall	

31.1. Scenario 3: No PMP + Roaming

In this scenario there is no PMP interface that can be used for a connection. The router scans the available mobile networks at boot and sorts the networks according to signal strength.

The network that offers the best signal strength will be the first to connect. Multi-WAN then controls the failover between the available networks.

Multi-WAN periodically does a health check on the interface. A health check comprises of a configurable combination of the following:

- Interface state
- Pings to an ICMP target
- Signal level checks using signal threshold, RSCP threshold and ECIO threshold option values

A fail for any of the above health checks results in a fail. After a configurable number of health check failures, Multi-WAN will disconnect the failed interface and attempt to connect to the next best roaming interface.

31.2. Configuring Firewall Using The Web Interface

In the top menu, select **Network -> Firewall**. The Firewall page appears. It is divided into three sections:

Section	Description
General Settings	Defines the firewall zones, both global and specific.
Port Forwards	Port Forwards are also known as Redirects. This section creates the redirects using DNAT (Destination Network Address Translation) with Netfilter.
Traffic Rules	Defines rules to allow or restrict access to specific ports, hosts or protocols.

31.2.1. Firewall - Zone Settings - General Settings Page

The General Setting page is divided into two sections.

Section	Description
General Settings	Defines the global firewall setting that do not belong to any specific zones.
Zones	The zones section groups one or more interfaces and serves as a source or destination for forwardings, rules and redirects. Masquerading (NAT) of outgoing traffic is controlled on a per-zone basis.

Firewall - Zone Settings - General Settings section

The General Settings page, or defaults section declares global firewall settings that do not belong to any specific zones. These default rules take effect last and more specific rules take effect first.

The Firewall - Zone settings - general settings page

Web Field/UCI/Package Option	Description						
Web: Enable SYN-flood protection UCI: firewall.defaults.syn_flood Opt: syn_flood	Enables SYN flood protection. <table border="1"> <tr> <td>0</td> <td>Disabled</td> </tr> <tr> <td>Default: 1</td> <td>Enabled</td> </tr> </table>	0	Disabled	Default: 1	Enabled		
0	Disabled						
Default: 1	Enabled						
Web: Drop invalid packets UCI: firewall.defaults.drop_invalid Opt: drop_invalid	Drops packets not matching any active connection. <table border="1"> <tr> <td>Default: 0</td> <td>Disabled</td> </tr> <tr> <td>1</td> <td>Enabled</td> </tr> </table>	Default: 0	Disabled	1	Enabled		
Default: 0	Disabled						
1	Enabled						
Web: Input UCI: firewall.defaults.input Opt: input	Default policy for the Input chain. <table border="1"> <tr> <td>Default: Accept</td> <td>Accepted packets pass through the firewall.</td> </tr> <tr> <td>Reject</td> <td>Rejected packets are blocked by the firewall and ICMP message is returned to the source host.</td> </tr> <tr> <td>Drop</td> <td>Dropped packets are blocked by the firewall.</td> </tr> </table>	Default: Accept	Accepted packets pass through the firewall.	Reject	Rejected packets are blocked by the firewall and ICMP message is returned to the source host.	Drop	Dropped packets are blocked by the firewall.
Default: Accept	Accepted packets pass through the firewall.						
Reject	Rejected packets are blocked by the firewall and ICMP message is returned to the source host.						
Drop	Dropped packets are blocked by the firewall.						
Web: Output UCI: firewall.defaults.output Opt: output	Default policy for the Output chain. <table border="1"> <tr> <td>Default: Accept</td> <td>Accepted packets pass through the firewall.</td> </tr> <tr> <td>Reject</td> <td>Rejected packets are blocked by the firewall and ICMP message is returned to the source host.</td> </tr> <tr> <td>Drop</td> <td>Dropped packets are blocked by the firewall.</td> </tr> </table>	Default: Accept	Accepted packets pass through the firewall.	Reject	Rejected packets are blocked by the firewall and ICMP message is returned to the source host.	Drop	Dropped packets are blocked by the firewall.
Default: Accept	Accepted packets pass through the firewall.						
Reject	Rejected packets are blocked by the firewall and ICMP message is returned to the source host.						
Drop	Dropped packets are blocked by the firewall.						
Web: Forward UCI: firewall.defaults.forward Opt: forward	Default policy for the Forward chain. <table border="1"> <tr> <td>Accept</td> <td>Accepted packets pass through the firewall.</td> </tr> <tr> <td>Default: Reject</td> <td>Rejected packets are blocked by the firewall and ICMP message is returned to the source host.</td> </tr> <tr> <td>Drop</td> <td>Dropped packets are blocked by the firewall.</td> </tr> </table>	Accept	Accepted packets pass through the firewall.	Default: Reject	Rejected packets are blocked by the firewall and ICMP message is returned to the source host.	Drop	Dropped packets are blocked by the firewall.
Accept	Accepted packets pass through the firewall.						
Default: Reject	Rejected packets are blocked by the firewall and ICMP message is returned to the source host.						
Drop	Dropped packets are blocked by the firewall.						

Firewall - Zone Settings - Zones Settings section

The Zones section groups one or more interfaces and serves as a source or destination for forwardings, rules and redirects. Masquerading (NAT) of outgoing traffic is controlled on a per-zone basis. To view a zone's settings, click **Edit**. The Firewall - Zone Settings - Zone "[name]" page appears.

The number of concurrent dynamic/static NAT entries of any kind (NAT/PAT/DNAT/SNAT) is not limited in any way by software; the only hardware limitation is the amount of RAM installed on the device.

There are two sections in Firewall - Zone Settings - Zone "x" page: General Settings and Advanced settings

Firewall zone: general settings

General Settings Port Forwards Traffic Rules

Firewall - Zone Settings - Zone "lan"

Zone "lan"

This section defines common properties of "lan". The *input* and *output* options set the default policies for traffic entering and leaving this zone while the *forward* option describes the policy for forwarded traffic between different networks within the zone. *Covered networks* specifies which available networks are member of this zone.

General Settings Advanced Settings

Name:

Input:

Output:

Forward:

Masquerading:

MSS clamping:

Covered networks:

- LAN1: (no interfaces attached)
- LAN2:
- LAN3:
- MOBILE1:
- PoAADSL:
- loopback:

The Firewall - zone settings - general settings tab

Web Field/UCI/Package Option	Description						
Web: name UCI: firewall.<zone label>.name Opt: name	Sets the unique zone name. Maximum of 11 characters allowed. Note: the zone label is obtained by using the 'uci show firewall' command and is of the format '@zone[x]' where x is an integer starting at 0.						
Web: Input UCI: firewall.<zone label>.input Opt: input	Default policy for incoming zone traffic. Incoming traffic is traffic entering the router through an interface selected in the 'Covered Networks' option for this zone. <table border="1" data-bbox="571 465 1401 595"> <tr> <td>Accept</td> <td>Accepted packets pass through the firewall.</td> </tr> <tr> <td>Reject</td> <td>Rejected packets are blocked by the firewall and ICMP message is returned to the source host.</td> </tr> <tr> <td>Default: Drop</td> <td>Dropped packets are blocked by the firewall.</td> </tr> </table>	Accept	Accepted packets pass through the firewall.	Reject	Rejected packets are blocked by the firewall and ICMP message is returned to the source host.	Default: Drop	Dropped packets are blocked by the firewall.
Accept	Accepted packets pass through the firewall.						
Reject	Rejected packets are blocked by the firewall and ICMP message is returned to the source host.						
Default: Drop	Dropped packets are blocked by the firewall.						
Web: Output UCI: firewall.<zone label>.output Opt: output	Default policy for outgoing zone traffic. Outgoing traffic is traffic leaving the router through an interface selected in the 'Covered Networks' option for this zone. <table border="1" data-bbox="571 689 1401 819"> <tr> <td>Accept</td> <td>Accepted packets pass through the firewall.</td> </tr> <tr> <td>Reject</td> <td>Rejected packets are blocked by the firewall and ICMP message is returned to the source host.</td> </tr> <tr> <td>Default: Drop</td> <td>Dropped packets are blocked by the firewall.</td> </tr> </table>	Accept	Accepted packets pass through the firewall.	Reject	Rejected packets are blocked by the firewall and ICMP message is returned to the source host.	Default: Drop	Dropped packets are blocked by the firewall.
Accept	Accepted packets pass through the firewall.						
Reject	Rejected packets are blocked by the firewall and ICMP message is returned to the source host.						
Default: Drop	Dropped packets are blocked by the firewall.						
Web: Forward UCI: firewall.<zone label>.forward Opt: forward	Default policy for internal zone traffic between interfaces. Forward rules for a zone describe what happens to traffic passing between different interfaces within that zone. <table border="1" data-bbox="571 913 1401 1043"> <tr> <td>Accept</td> <td>Accepted packets pass through the firewall.</td> </tr> <tr> <td>Reject</td> <td>Rejected packets are blocked by the firewall and ICMP message is returned to the source host.</td> </tr> <tr> <td>Default: Drop</td> <td>Dropped packets are blocked by the firewall.</td> </tr> </table>	Accept	Accepted packets pass through the firewall.	Reject	Rejected packets are blocked by the firewall and ICMP message is returned to the source host.	Default: Drop	Dropped packets are blocked by the firewall.
Accept	Accepted packets pass through the firewall.						
Reject	Rejected packets are blocked by the firewall and ICMP message is returned to the source host.						
Default: Drop	Dropped packets are blocked by the firewall.						
Web: Masquerading UCI: firewall.<zone label>.masq Opt: masq	Specifies whether outgoing zone traffic should be masqueraded (NATTED). This is typically enabled on the wan zone.						
Web: MSS Clamping UCI: firewall.<zone label>.mtu_fix Opt: mtu_fix	Enables MSS clamping for outgoing zone traffic. Subnets are allowed. <table border="1" data-bbox="571 1249 756 1321"> <tr> <td>Default: 0</td> <td>Disabled</td> </tr> <tr> <td>1</td> <td>Enabled</td> </tr> </table>	Default: 0	Disabled	1	Enabled		
Default: 0	Disabled						
1	Enabled						
Web: Covered Networks UCI: firewall.<zone label>.network Opt:	Defines a list of interfaces attached to this zone, if omitted, the value of name is used by default. Note: use the uci list syntax to edit this setting though UCI.						

Firewall zone: advanced settings

General Settings Port Forwards Traffic Rules

Firewall - Zone Settings - Zone "lan"

Zone "lan"

This section defines common properties of "lan". The *input* and *output* options set the default policies for traffic entering and leaving this zone while the *forward* option describes the policy for forwarded traffic between different networks within the zone. *Covered networks* specifies which available networks are member of this zone.

General Settings Advanced Settings

Restrict to address family: IPv4 and IPv6

Restrict Masquerading to given source subnets: 0.0.0.0/0

Restrict Masquerading to given destination subnets: 0.0.0.0/0

Force connection tracking:

Enable logging on this zone:

Allow NAT Reflections:

The Firewall - zone settings - advanced settings tab

Web Field/UCI/Package Option	Description												
Web: Restrict to address family UCI: firewall. <zone label>.family Opt: family	Restricts zone to IPv4, IPv6 or both IPv4 and IPv6. <table border="1"> <thead> <tr> <th>Option</th> <th>Description</th> <th>UCI</th> </tr> </thead> <tbody> <tr> <td>IPv4 and IPv6</td> <td>Any address family</td> <td>any</td> </tr> <tr> <td>IPv4 only</td> <td>IPv4 only</td> <td>ipv4</td> </tr> <tr> <td>IPv6 only</td> <td>IPv6 only</td> <td>ipv6</td> </tr> </tbody> </table>	Option	Description	UCI	IPv4 and IPv6	Any address family	any	IPv4 only	IPv4 only	ipv4	IPv6 only	IPv6 only	ipv6
Option	Description	UCI											
IPv4 and IPv6	Any address family	any											
IPv4 only	IPv4 only	ipv4											
IPv6 only	IPv6 only	ipv6											
Web: Restrict Masquerading to given source subnets UCI: firewall. <zone label>.masq_src Opt: masq_src	Limits masquerading to the given source subnets. Negation is possible by prefixing the subnet with '!'. Multiple subnets are allowed.												
Web: Restrict Masquerading to given destination subnets UCI: firewall. <zone label>.masq_dest Opt: masq_dest	Limits masquerading to the given destination subnets. Negation is possible by prefixing the subnet with '!'. Multiple subnets are allowed. Multiple IP addresses/subnets should be separated by a space, for example: option masq_dest '1.1.1.1 2.2.2.0/24'.												
Web: Force connection tracking UCI: firewall. <zone label>.contrack Opt: contrack	Forces connection tracking for this zone. <table border="1"> <tbody> <tr> <td>0</td> <td>Disabled</td> </tr> <tr> <td>Default: 1</td> <td>If masquerading is used. Otherwise, default is 0.</td> </tr> </tbody> </table>	0	Disabled	Default: 1	If masquerading is used. Otherwise, default is 0.								
0	Disabled												
Default: 1	If masquerading is used. Otherwise, default is 0.												
Web: Enable logging on this zone UCI: firewall. <zone label>.log Opt: log	Creates log rules for rejected and dropped traffic in this zone.												
Web: Allow NAT reflections UCI: firewall. <zone label>.reflection Opt: reflection	Enable/disable all NAT reflections for this zone. Note: for configs with a large number of firewall rules, disabling NAT reflection will speed up load of firewall rules on interface start. <table border="1"> <tbody> <tr> <td>0</td> <td>Disable reflection</td> </tr> <tr> <td>Default: 1</td> <td>Enable reflection</td> </tr> </tbody> </table>	0	Disable reflection	Default: 1	Enable reflection								
0	Disable reflection												
Default: 1	Enable reflection												
Web: n/a UCI: firewall. <zone label>.log_limit Opt: log_limit	Limits the amount of log messages per interval.												

Inter-zone forwarding

This section controls the traffic flow between zones. Selecting a source or destination zone generates a forwarding rule. Only one direction is covered by any forwarding rule. Hence for bidirectional traffic flow between two zones then two rules are required, with source and destination alternated.

Inter-Zone Forwarding

The options below control the forwarding policies between this zone (lan) and other zones. *Destination zones* cover forwarded traffic **originating from "lan"**. *Source zones* match forwarded traffic from other zones **targeted at "lan"**. The forwarding rule is *unidirectional*, e.g. a forward from lan to wan does *not* imply a permission to forward from wan to lan as well.

Allow forward to destination zones: wan: MOBILE1: PoAADSL:

Allow forward from source zones: wan: MOBILE1: PoAADSL:

The inter-zone forwarding section

Web Field/UCI/Package Options	Description
Web: Allow forward to destination zones UCI: firewall. <forwarding label>.dest Opt: dest	Allows forward to other zones. Enter the current zone as the source. Enabling this option puts two entries into the firewall file: destination and source.
UCI: firewall. <forwarding label>.src Opt: src	
Web: Allow forward from source zones UCI: firewall.<forwarding label>.dest Opt: dest	Allows forward from other zones. Enter the current zone as the destination. Enabling this option puts two entries into the firewall file: destination and source.
UCI: firewall. <forwarding label>.src Opt: src	

31.2.2. Firewall Port Forwards Page

Port forwards are also known as redirects. The Firewall Port Forwards section creates the redirects using DNAT (Destination Network Address Translation) with Netfilter. The redirects are from the firewall zone labelled as wan to the firewall zone labelled as lan. These zones can refer to multiple external and internal interfaces as defined in the Firewall Zone settings.

The screenshot displays the 'Firewall - Port Forwards' configuration page. At the top, there are tabs for 'General Settings', 'Port Forwards', and 'Traffic Rules'. The main heading is 'Firewall - Port Forwards' with a sub-heading 'Port forwarding allows remote computers on the Internet to connect to a specific computer or service within the private LAN.' Below this is a table titled 'Port Forwards' with the following columns: Name, Protocol, Source, Via, Destination, Enable, and Sort. A single entry is shown: 'HTTPS' (Name), 'TCP' (Protocol), 'From any host in wan' (Source), 'To any router IP at port 443' (Via), 'Forward to IP 192.168.100.100, port 443 in lan' (Destination), and 'Enable' (checked). To the right of the entry are 'Edit' and 'Delete' buttons. Below the table is a 'New port forward:' section with a form containing fields for 'Name' (with a placeholder 'New port forward'), 'Protocol' (a dropdown menu set to 'TCP+UDP'), 'External port' (an empty text box), 'Internal IP address' (a dropdown menu), and 'Internal port' (an empty text box), followed by an 'Add' button.

To edit an existing port forward select **edit**. To add a new port forward select **add**.

Web Field/UCI/Package Option	Description												
Web: name UCI: firewall.<redirect label>.name Opt: name	Sets the port forwarding name. For Web UI generated redirects the <redirect label> takes the form of @redirect[x], where x is an integer starting from 0.												
Web: Protocol UCI: firewall.<redirect label>.proto Opt: proto	Defines layer 4 protocol to match incoming traffic. <table border="1"> <thead> <tr> <th>Option</th> <th>Description</th> <th>UCI</th> </tr> </thead> <tbody> <tr> <td>Default: tcp+udp</td> <td>Match either TCP or UDP packets</td> <td>tcp udp</td> </tr> <tr> <td>tcp</td> <td>Match TCP packets only</td> <td>tcp</td> </tr> <tr> <td>udp</td> <td>Match UDP packets only</td> <td>udp</td> </tr> </tbody> </table>	Option	Description	UCI	Default: tcp+udp	Match either TCP or UDP packets	tcp udp	tcp	Match TCP packets only	tcp	udp	Match UDP packets only	udp
Option	Description	UCI											
Default: tcp+udp	Match either TCP or UDP packets	tcp udp											
tcp	Match TCP packets only	tcp											
udp	Match UDP packets only	udp											
Web: External port UCI: firewall.<redirect label>.src_dport Opt: src_dport	Specifies the incoming TCP/UDP port or port range to match. This is the incoming destination port specified by the external host. Port ranges specified as start:stop, for example, 2001:2020. <table border="1"> <tbody> <tr> <td>Default: Blank</td> <td>Match traffic to any port</td> </tr> <tr> <td>Range</td> <td>1-65535</td> </tr> </tbody> </table>	Default: Blank	Match traffic to any port	Range	1-65535								
Default: Blank	Match traffic to any port												
Range	1-65535												
Web: Internal IP address UCI: firewall.<redirect label>.dest_ip Opt: dest_ip	Specifies the internal (LAN) IP address for the traffic to be redirected to.												
Web: Internal port UCI: firewall.<redirect label>.dest_port Opt: dest_port	Specifies the destination tcp/udp port for the redirect traffic.												

The defined redirects can be sorted into a specific order to be applied. More specific rules should be placed first.

After the redirect is created and saved, to make changes, click **Edit**. This will provide further options to change the source/destination zones; specify source MAC addresses and enable NAT loopback (reflection).

General Settings | Port Forwards | **Traffic Rules**

Firewall - Port Forwards - (Unnamed Entry)

This page allows you to change advanced properties of the port forwarding entry. In most cases there is no need to modify those settings.

Rule is enabled

Name

Protocol

Source zone

- lan: LAN1: LAN2: LAN3:
- wan: MOBILE1: PoAADSL:

Source MAC address
 Only match incoming traffic from these MACs.

Source IP address Only match incoming traffic from this IP or range.

Source port Only match incoming traffic originating from the given source port or port range on the client host

External IP address Only match incoming traffic directed at the given IP address.

External port Match incoming traffic directed at the given destination port or port range on this host

Internal zone

- lan: LAN1: LAN2: LAN3:
- wan: MOBILE1: PoAADSL:

Internal IP address Redirect matched incoming traffic to the specified internal host

Internal port Redirect matched incoming traffic to the given port on the internal host

Enable NAT Loopback

Extra arguments Passes additional arguments to iptables. Use with care!

The firewall port forwards edits page

Web Field/UCI/Package Option	Description												
Web: Rule is enabled UCI: firewall.<redirect label>.enabled Opt: enabled	Specifies if this redirect should be enabled or disabled. <table border="1"> <tr> <td>0</td> <td>Disabled</td> </tr> <tr> <td>Default: 1</td> <td>Enabled</td> </tr> </table>	0	Disabled	Default: 1	Enabled								
0	Disabled												
Default: 1	Enabled												
Web: Name UCI: firewall.<redirect label>.name Opt: name	Sets the port forwarding name. For Web UI generated redirects the <redirect label> takes the form of @redirect[x], where x is an integer starting from 0.												
Web: Protocol UCI: firewall.<redirect label>.proto Opt: proto	Defines layer 4 protocol to match incoming traffic. <table border="1"> <thead> <tr> <th>Option</th> <th>Description</th> <th>UCI</th> </tr> </thead> <tbody> <tr> <td>Default: tcp+udp</td> <td>Match either TCP or UDP packets</td> <td>tcp udp</td> </tr> <tr> <td>tcp</td> <td>Match TCP packets only</td> <td>tcp</td> </tr> <tr> <td>udp</td> <td>Match UDP packets only</td> <td>udp</td> </tr> </tbody> </table>	Option	Description	UCI	Default: tcp+udp	Match either TCP or UDP packets	tcp udp	tcp	Match TCP packets only	tcp	udp	Match UDP packets only	udp
Option	Description	UCI											
Default: tcp+udp	Match either TCP or UDP packets	tcp udp											
tcp	Match TCP packets only	tcp											
udp	Match UDP packets only	udp											
Web: Source zone UCI: firewall.<redirect label>.src Opt: src	Specifies the traffic source zone. It must refer to one of the defined zone names. When using the web interface, this is set to WAN initially.												
Web: Source MAC address UCI: firewall.<redirect label>.src_mac Opt: list src_mac	Defines the list of source MAC addresses that this redirect will match. Format: aa:bb:cc:dd:ee:ff Multiple RIP interfaces are entered using <code>uci set</code> and <code>uci add_list</code> commands. Example: <pre>uci set firewall.@redirect[0].src_mac=aa:bb:cc:dd:ee:ff uci add_list firewall.@redirect[0].src_mac=12:34:56:78:90:12</pre> or using a list of options via package options <pre>list network 'aa:bb:cc:dd:ee:ff' list network '12:34:56:78:90:12'</pre>												
Web: Source IP address UCI: firewall.<redirect label>.src_ip Opt: src_ip	Defines a source IP address that this redirect will match. <table border="1"> <tr> <td>Default: Blank</td> <td>Match traffic from any source IP</td> </tr> <tr> <td>Range</td> <td>A.B.C.D/mask</td> </tr> </table>	Default: Blank	Match traffic from any source IP	Range	A.B.C.D/mask								
Default: Blank	Match traffic from any source IP												
Range	A.B.C.D/mask												
Web: Source port UCI: firewall.<redirect label>.src_port Opt: src_port	Defines a source IP port that this redirect will match. You can enter multiple ports, using a space separator. *For example: option src_port '22 23' *see note below on use with options src_dport and dest_port <table border="1"> <tr> <td>Default: Blank</td> <td>Match traffic from any source IP</td> </tr> <tr> <td>Range</td> <td>1 - 65535</td> </tr> </table>	Default: Blank	Match traffic from any source IP	Range	1 - 65535								
Default: Blank	Match traffic from any source IP												
Range	1 - 65535												
Web: External port UCI: firewall.<redirect label>.src_dport Opt: src_dport	Specifies the incoming TCP/UDP port or port range to match. This is the incoming destination port specified by the external host. Port ranges specified in format start:stop, for example, 2001:2020. You can enter multiple ports, using a space separator. *For example: option src_dport '22 23'												

Web Field/UCI/Package Option	Description				
	<p>*see note below on use with options src_port and dest_port</p> <table border="1"> <tr> <td>Default: Blank</td> <td>Match traffic from any source IP</td> </tr> <tr> <td>Range</td> <td>1 - 65535</td> </tr> </table>	Default: Blank	Match traffic from any source IP	Range	1 - 65535
Default: Blank	Match traffic from any source IP				
Range	1 - 65535				
Web: Internal zone UCI: firewall.<redirect label>.dest Opt: dest	Specifies the traffic destination zone, must refer to one of the defined zone names.				
Web: Internal IP address UCI: firewall.<redirect label>.dest_port Opt: dest_port	Specifies the internal (LAN) IP address for the traffic to be redirected to.				
Web: Internal zone UCI: firewall.<redirect label>.dest_ip Opt: dest_ip	Specifies the destination tcp/udp port for the redirect traffic. You can enter multiple ports, using a space separator. *For example: option dest_port '22 23' *See note below table on use with options src_port and src_dport.				
Web: Enable NAT Loopback UCI: firewall.<redirect label>.reflection Opt: reflection	Enable or disable NAT reflection for this redirect. <table border="1"> <tr> <td>0</td> <td>Reflection disabled</td> </tr> <tr> <td>Default: 1</td> <td>Reflection enabled</td> </tr> </table>	0	Reflection disabled	Default: 1	Reflection enabled
0	Reflection disabled				
Default: 1	Reflection enabled				
Web: Extra arguments UCI: firewall.<redirect label>.extra Opt: extra	Passes extra arguments to IP tables. This is useful to specify additional match options, like -m policy --dir in for IPSec. The arguments are entered as text strings.				



NOTE

*redirect rule options src_port and src_dport/dest_port accept space-separated lists of ports. If src_port is a list, then src_dport/dst_port cannot be, to avoid ambiguity.

If src_dport/dest_port are lists of different lengths, then the missing values of the shorter list default to the corresponding port in the other list. For example, if configuration file is:

```
option src_dport '21 22 23'
option dest_port '21 22 23 24'
```

then the firmware will interpret the values as:

```
option src_dport '21 22 23 24'
option dest_port '21 22 23 24'
```

31.2.3. Firewall Traffic Rules Page

Rules can be defined to allow or restrict access to specific ports, hosts or protocols.

Firewall - Traffic Rules - (Unnamed Rule)

This page allows you to change advanced properties of the traffic rule entry, such as matched source and destination hosts.

Rule is enabled

Name

Restrict to address family

Protocol

Match ICMP type

Source zone

- Any zone
- lan: LAN1: LAN2: LAN3:
- wan: MOBILE1: PoAADSL:

Source MAC address

Source address

Source port

Destination zone

- Device (input)
- Any zone (forward)
- lan: LAN1: LAN2: LAN3:
- wan: MOBILE1: PoAADSL:

Destination address

Destination port

Action

Extra arguments Passes additional arguments to iptables. Use with care!

The firewall traffic rules page

Web Field/UCI/Package Option	Description																		
Web: Rule is enabled UCI: firewall.<rule label>.enabled Opt: enabled	Enables or disables traffic rule. <table border="1"> <tr> <td>0</td> <td>Rule is disabled</td> </tr> <tr> <td>Default: 1</td> <td>Rule is enabled</td> </tr> </table>	0	Rule is disabled	Default: 1	Rule is enabled														
0	Rule is disabled																		
Default: 1	Rule is enabled																		
Web: Name UCI: firewall.<rule label>.name Opt: name	Select a descriptive name limited to less than 11 characters. No spaces are allowed in the naming convention.																		
Web: Restrict to address family UCI: firewall.<rule label>.family Opt: family	Restrict to protocol family. <table border="1"> <thead> <tr> <th>Option</th> <th>Description</th> <th>UCI</th> </tr> </thead> <tbody> <tr> <td>Default: IPv4 and IPv6</td> <td>Traffic rule applies to any address family</td> <td>any</td> </tr> <tr> <td>IPv4 only</td> <td>IPv4 only</td> <td>ipv4</td> </tr> <tr> <td>IPv6 only</td> <td>IPv6 only</td> <td>ipv6</td> </tr> </tbody> </table>	Option	Description	UCI	Default: IPv4 and IPv6	Traffic rule applies to any address family	any	IPv4 only	IPv4 only	ipv4	IPv6 only	IPv6 only	ipv6						
Option	Description	UCI																	
Default: IPv4 and IPv6	Traffic rule applies to any address family	any																	
IPv4 only	IPv4 only	ipv4																	
IPv6 only	IPv6 only	ipv6																	
Web: Protocol UCI: firewall.<rule label>.proto Opt: proto	Matches incoming traffic using the given protocol. <table border="1"> <thead> <tr> <th>Option</th> <th>Description</th> <th>UCI</th> </tr> </thead> <tbody> <tr> <td>Default: tcp+udp</td> <td>Applies rule to TCP and UDP only</td> <td>tcp udp</td> </tr> <tr> <td>tcp</td> <td>Applies rule to TCP only</td> <td>tcp</td> </tr> <tr> <td>udp</td> <td>Applies rule to UDP only</td> <td>udp</td> </tr> <tr> <td>ICMP</td> <td>Applies rule to ICMP only</td> <td>icmp</td> </tr> <tr> <td>custom</td> <td>Specify protocol from /etc/protocols</td> <td></td> </tr> </tbody> </table>	Option	Description	UCI	Default: tcp+udp	Applies rule to TCP and UDP only	tcp udp	tcp	Applies rule to TCP only	tcp	udp	Applies rule to UDP only	udp	ICMP	Applies rule to ICMP only	icmp	custom	Specify protocol from /etc/protocols	
Option	Description	UCI																	
Default: tcp+udp	Applies rule to TCP and UDP only	tcp udp																	
tcp	Applies rule to TCP only	tcp																	
udp	Applies rule to UDP only	udp																	
ICMP	Applies rule to ICMP only	icmp																	
custom	Specify protocol from /etc/protocols																		
Web: Match ICMP type UCI: firewall.<rule label>.icmp_type Opt: icmp_type	Match specific icmp types. This option is only valid when ICMP is selected as the protocol. ICMP types can be listed as either type names or type numbers. Note: for a full list of valid ICMP type names, see the ICMP Options table below.																		
Web: Source zone UCI: firewall.<rule label>.src Opt: src	Specifies the traffic source zone, must refer to one of the defined zone names. For typical port forwards, this is usually WAN.																		
Web: Source MAC address UCI: firewall.<rule label>.src_mac Opt: src_mac	Matches incoming traffic from the specified MAC address. The MAC address must be entered in the following format: aa:bb:cc:dd:ee:ff. To only match the first portion of the MAC address append / prefix to the option value, where prefix defines the bits from the start of the MAC to match on. Example: <pre>option src_mac 00:E0:C8:12:34:56/24</pre> will match on all packets with prefix 00:E0:C8.																		
Web: Source address UCI: firewall.<rule label>.src_ip Opt: src_ip	Matches incoming traffic from the specified source IP address.																		
Web: Source port UCI: firewall.<rule label>.src_port Opt: src_port	Matches incoming traffic originating from the given source port or port range on the client host.																		
Web: Destination zone UCI: firewall.<rule label>.dest Opt: dest	Specifies the traffic destination zone. Must refer to one of the defined zone names.																		

Web Field/UCI/Package Option	Description															
Web: Destination address UCI: firewall.<rule label>.dest_ip Opt: dest_ip	For DNAT, redirects matched incoming traffic to the specified internal host. For SNAT, matches traffic directed at the given address.															
Web: Destination port UCI: firewall.<rule label>.dest_port Opt: dest_port	For DNAT, redirects matched incoming traffic to the given port on the internal host. For SNAT, matches traffic directed at the given ports.															
Web: Action UCI: firewall.<rule label>.target Opt: target	Action to take when rule is matched. <table border="1"> <thead> <tr> <th>Option</th> <th>Description</th> <th>UCI</th> </tr> </thead> <tbody> <tr> <td>drop</td> <td>Drop matching traffic</td> <td>drop</td> </tr> <tr> <td>Default: accept</td> <td>Allow matching traffic</td> <td>accept</td> </tr> <tr> <td>reject</td> <td>Reject matching traffic</td> <td>reject</td> </tr> <tr> <td>don't track</td> <td>Disable connection tracking for the rule. See the Connection Tracking section below for more information.</td> <td>No Track</td> </tr> </tbody> </table>	Option	Description	UCI	drop	Drop matching traffic	drop	Default: accept	Allow matching traffic	accept	reject	Reject matching traffic	reject	don't track	Disable connection tracking for the rule. See the Connection Tracking section below for more information.	No Track
Option	Description	UCI														
drop	Drop matching traffic	drop														
Default: accept	Allow matching traffic	accept														
reject	Reject matching traffic	reject														
don't track	Disable connection tracking for the rule. See the Connection Tracking section below for more information.	No Track														
Web: Extra arguments UCI: firewall.<rule label>.extra Opt: extra	Passes extra arguments to IP tables. This is useful to specify additional match options, like -m policy --dir in for IPsec.															
Web: n/a UCI: firewall.<rule label>.reflection Opt: reflection	Disables NAT reflection for this redirect if set to 0. Applicable to DNAT targets.															
Web: n/a UCI: firewall.<rule label>.limit Opt: limit	Sets maximum average matching rate; specified as a number, with an optional / second, /minute, /hour or /day suffix. Example: 3/hour.															
Web: n/a UCI: firewall.<rule label>.limit_burst Opt: limit_burst	Sets maximum initial number of packets to match. This number gets recharged by one every time the limit specified above is not reached, up to this number.															
Web: n/a UCI: firewall.<rule label>.recent Opt: recent	Sets number of allowed connections within specified time. This command takes two values e.g. recent=2 120 will allow 2 connections within 120 seconds.															

ICMP Options	ICMP Options	ICMP Options	ICMP Options
address-mask-reply	host-redirect	pong	time-exceeded
address-mask-request	host-unknown	port-unreachable	timestamp-reply
any	host-unreachable	precedence-cutoff	timestamp-request
communication- prohibited	ip-header-bad	protocol-unreachable	TOS-host-redirect
destination-unreachable	network-prohibited	redirect	TOS-host-unreachable
echo-reply	network-redirect	required-option-missing	TOS-network-redirect
echo-request	network-unknown	router-advertisement	TOS-network- unreachable
fragmentation-needed	network-unreachable	router-solicitation	ttl-exceeded
host-precedence- violation	parameter-problem	source-quench	ttl-zero-during- reassembly
host-prohibited	ping	source-route-failed	ttl-zero-during-transit

31.3. Configuring Firewall Using UCI

Firewall is configured under the firewall package `/etc/config/firewall`.

There are six config sections: `defaults`, `zone`, `forwarding`, `redirect`, `rule` and `include`. You can configure multiple `zone`, `forwarding` and `redirect` sections.

Firewall: General Settings

To set general (default) settings, enter:

```
uci add firewall defaults
uci set firewall.@defaults[0].syn_flood=1
uci set firewall.@defaults[0].drop_invalid=1
uci set firewall.@defaults[0].input=ACCEPT
uci set firewall.@defaults[0].output=ACCEPT
uci set firewall.@defaults[0].forward=ACCEPT
```



NOTE

This command is only required if there is no `defaults` section.

Firewall Zone Settings

By default, all firewall zone instances are named `zone`, instances are identified by `@zone` then the zone position in the package as a number. For example, for the first zone in the package using UCI, enter:

```
firewall.@zone[0]=zone
firewall.@zone[0].name=lan
```

Or using package options:

```
config zone
option name 'lan'
```

To set up a firewall zone, enter:

```
uci add firewall zone
uci set firewall.@zone[1].name=lan
uci set firewall.@zone[1].input=ACCEPT
uci set firewall.@zone[1].output=ACCEPT
uci set firewall.@zone[1].forward=ACCEPT
uci set firewall.@zone[1].network=lan1wifi_client
uci set firewall.@zone[1].family=any
uci set firewall.@zone[1].masq_src=10.0.0.0/24
uci set firewall.@zone[1].masq_dest=20.0.0.0/24
uci set firewall.@zone[1].contrack=1
uci set firewall.@zone[1].masq=1
uci set firewall.@zone[1].mtu_fix=1
uci set firewall.@zone[1].log=1
uci set firewall.@zone[1].log_limit=5
```

Inter-zone Forwarding

By default, all inter-zone instances are named 'forwarding'; instances are identified by @forwarding then the forwarding position in the package as a number. For example, for the first forwarding in the package using UCI, enter:

```
firewall.@forwarding[0]=forwarding
firewall.@forwarding[0].src=lan
```

Or using package options:

```
config forwarding
option src 'lan'
```

To enable forwarding of traffic from WAN to LAN, enter:

```
uci add firewall forwarding
uci set firewall.@forwarding[1].dest=wan
uci set firewall.@forwarding[1].src=lan
```

Firewall Port Forwards

By default, all port forward instances are named 'redirect'; instances are identified by @redirect then the redirect position in the package as a number. For example, for the first redirect in the package using UCI, enter:

```
firewall.@redirect[0]=redirect
firewall.@redirect[0].name=Forward
```

Or using package options:

```
config redirect
option name 'Forward'
```

To set port forwarding rules, enter:

```
uci add firewall redirect
uci set firewall.@redirect[1].name=Forward
uci set firewall.@redirect[1].proto=tcp
uci set firewall.@redirect[1].src=wan # <- zone names uci set firewall.@redirect[1].dest=lan # <- zone names
uci set firewall.@redirect[1].src_dport=2001
uci set firewall.@redirect[1].dest_ip=192.168.0.100
uci set firewall.@redirect[1].dest_port=2005
uci set firewall.@redirect[1].enabled=1
```

Firewall Traffic Rules

By default, all traffic rules instances are named rule, instances are identified by @rule then the rule position in the package as a number. For example, for the first rule in the package using UCI, enter:

```
firewall.@rule[0]=rule
firewall.@rule[0].enabled=1
```

Or using package options:

```
config rule
option enabled '1'
```

To set traffic rules, enter:

```

uci add firewall rule

uci set firewall.@rule[1].enabled=1

uci set firewall.@rule[1].name=Allow_ICMP

uci set firewall.@rule[1].family=any

uci set firewall.@rule[1].proto=ICMP

uci set firewall.@rule[1].icmp_type=any

uci set firewall.@rule[1].src=wan

uci set firewall.@rule[1].src_mac=ff:ff:ff:ff:ff:ff

uci set firewall.@rule[1].src_port=

uci set firewall.@rule[1].dest=lan

uci set firewall.@rule[1].dest_port=

uci set firewall.@rule[1].dest_ip=192.168.100.1

uci set firewall.@rule[1].target=ACCEPT

uci set firewall.@rule[1].extra=

uci set firewall.@rule[1].src_ip=8.8.8.8

uci set firewall.@rule[1].src_dip=9.9.9.9

uci set firewall.@rule[1].src_dport=68

uci set firewall.@rule[1].reflection=1

uci set firewall.@rule[1].limit=3/second

uci set firewall.@rule[1].limit_burst=30

```

Custom Firewall Scripts: Includes

It is possible to include custom firewall scripts by specifying one or more include sections in the firewall configuration.

There is only one possible parameter for includes:

Parameter	Description
pth	Specifies a shell script to execute on boot or firewall restarts.

Custom scripts are executed as shell scripts and are expected to contain iptables commands.

IPv6 Notes

As described above, the option family is used for distinguishing between IPv4, IPv6 and both protocols. However, the family is inferred automatically if a specific IP address family is used. For example, if IPv6 addresses are used then the rule is automatically treated as IPv6 only rule.

```

config rule

    option src wan

    option src_ip fdca:f00:ba3::/64

    option target ACCEPT

```

Similarly, the following rule is automatically treated as IPv4 only.

```
config rule
option src wan
option dest_ip 88.77.66.55
option target REJECT
```

Rules without IP addresses are automatically added to iptables and ip6tables, unless overridden by the family option. Redirect rules (port forwards) are always IPv4 since there is no IPv6 DNAT support at present.

31.3.1. Implications Of DROP Vs. REJECT

The decision whether to drop or to reject traffic should be done on a case-by-case basis. Many people see dropping traffic as a security advantage over rejecting it because it exposes less information to a hypothetical attacker. While dropping slightly increases

security, it can also complicate the debugging of network issues or cause unwanted side-effects on client programs.

If traffic is rejected, the router will respond with an icmp error message ("destination port unreachable") causing the connection attempt to fail immediately. This also means that for each connection attempt a certain amount of response traffic is generated. This can actually harm if the firewall is attacked with many simultaneous connection attempts, the resulting backfire of icmp responses can clog up all available upload and make the connection unusable (DoS).

When connection attempts are dropped the client is not aware of the blocking and will continue to re-transmit its packets until the connection eventually times out. Depending on the way the client software is implemented, this could result in frozen or hanging programs that need to wait until a timeout occurs before they're able to continue.

DROP

- less information is exposed
- less attack surface
- client software may not cope well with it (hangs until connection times out)
- may complicate network debugging (where was traffic dropped and why)

REJECT

- may expose information (like the IP at which traffic was actually blocked)
- client software can recover faster from rejected connection attempts
- network debugging easier (routing and firewall issues clearly distinguishable)

31.3.2. Connection Tracking

By default, the firewall will disable connection tracking for a zone if no masquerading is enabled. This is achieved by generating NOTRACK firewall rules matching all traffic passing via interfaces referenced by the firewall zone. The purpose of NOTRACK is to speed up routing and save memory by circumventing resource intensive connection tracking in cases where it is not needed. You can check if connection tracking is disabled by issuing `iptables -t raw -S`, it will list all rules, check for NOTRACK target.

NOTRACK will render certain iptables extensions unusable, for example the MASQUERADE target or the state match will not work.

If connection tracking is required, for example by custom rules in `/etc/firewall.user`, you must enable the `conntrack` option in the corresponding zone to disable NOTRACK. It should appear as option `'conntrack' '1'` in the right zone in `/etc/config/firewall`.

The default configuration accepts all LAN traffic, but blocks all incoming WAN traffic on ports not currently used for connections or NAT. To open a port for a service, add a rule section:

```
config rule
option src wan
option dest_port 22
option target ACCEPT
option proto tcp
```

This example enables machines on the internet to use SSH to access your router.

31.3.3. Firewall Rule Examples

Opening Ports

The default configuration accepts all LAN traffic, but blocks all incoming WAN traffic on ports not currently used for connections or NAT. To open a port for a service, add a rule section:

```
config rule
option src      wan
option dest_port 22
option target   ACCEPT
option proto    tcp
```

This example enables machines on the internet to use SSH to access your router.

Forwarding Ports (Destination NAT/DNAT)

This example forwards http, but not HTTPS, traffic to the web server running on 192.168.1.10:

```
config redirect
option src wan
option src_dport 80
option proto tcp
option dest_ip 192.168.1.10
```

The next example forwards one arbitrary port that you define to a box running SSH behind the firewall in a more secure manner because it is not using default port 22.

```
config 'redirect'
option 'name' 'ssh'
option 'src' 'wan'
option 'proto' 'tcpudp'
option 'src_dport' '5555'
option 'dest_ip' '192.168.1.100'
option 'dest_port' '22'
option 'target' 'DNAT'
option 'dest' 'lan'
```

Source NAT (SNAT)

Source NAT changes an outgoing packet destined for the system so that it looks as though the system is the source of the packet.

Define source NAT for UDP and TCP traffic directed to port 123 originating from the host with the IP address 10.55.34.85. The source address is rewritten to 63.240.161.99

```
config redirect
option src      lan
option dest     wan
option src_ip   10.55.34.85
option src_dip  63.240.161.99
option dest_port 123
option target   SNAT
```

When used alone, Source NAT is used to restrict a computer's access to the internet, but allows it to access a few services by manually forwarding what appear to be a few local services; for example, NTP to the internet. While DNAT hides the local network from the internet, SNAT hides the internet from the local network.

Source NAT and destination NAT are combined and used dynamically in IP masquerading to make computers with private (192.168.x.x, etc) IP addresses appear on the internet with the system's public WAN IP address.

True Destination Port Forwarding

This usage is similar to SNAT, but as the destination IP address is not changed, machines on the destination network need to be aware that they will receive and answer requests from a public IP address that is not necessarily theirs. Port forwarding in this fashion is typically used for load balancing.

```
config redirect
option src      wan
option src_dport 80
option dest     lan
option dest_port 80
option proto    tcp
```

Block Access to a Specific Host

The following rule blocks all connection attempts to the specified host address.

```
config rule
option src      lan
option dest     wan
option dest_ip  123.45.67.89
option target   REJECT
```

Block Access to the Internet using MAC

The following rule blocks all connection attempts from the client to the internet.

```
config rule
option src      lan
option dest     wan
option src_mac  00:00:00:00:00:00
option target   REJECT
```

Block Access to the Internet for Specific IP on Certain Times

The following rule blocks all connection attempts to the internet from 192.168.1.27 on weekdays between 21:00 and 09:00

```
config rule
option src      lan
option dest     wan
option src_ip   192.168.1.27
option extra    '-m time--weekdays Mon,Tue,Wed,Thu,Fri --
timestart 21:00 --timestop 09:00'
option target   REJECT
```

Restricted Forwarding Rule

The example below creates a forward rule rejecting traffic from LAN to WAN on the ports 1000-1100.

```
config rule
option src      lan
option dest     wan
option dest_port 1000-1100
option proto    tcpudp
option target   REJECT
```

Denial of Service Protection Rule

The example below shows a sample configuration of SSH DoS attack where if more than two SSH connections are attempted within 120 seconds, every further connection will be dropped. You can configure this for any port number.

```
config rule 'sshattack'
option src 'lan'
option dest_port '22'
option proto 'tcp'
option recent '2 120'
option target 'DROP'
```

IP Spoofing Prevention Mechanism

Configure IP spoofing protection on a per interface basis in the `/etc/config/network` configuration file. the example below shows the `ipv4_rp_filter` option enabled on the `Vlan12` interface in the network file. When reverse path filtering mechanism is enabled, the router will check whether a receiving packet source address is routable.

If it is routable through the interface from which it came, then the machine will accept the packet.

If it is not routable through the interface from which it came, then the machine will drop that packet.

```
config interface 'Vlan12'
option type 'bridge'
option proto 'static'
option monitored '0'
option ipaddr '10.1.28.122'
option netmask '255.255.0.0'
option ifname 'eth1 eth3.12'
option ipv4_rp_filter '1'
```

Simple DMZ Rule

The following rule redirects all WAN ports for all protocols to the internal host `192.168.1.2`.

```
config redirect
option src wan
option proto all
option dest_ip 192.168.1.2
```

Transparent Proxy Rule (External)

The following rule redirects all outgoing HTTP traffic from LAN through an external proxy at `192.168.1.100` listening on port `3128`. It assumes the router LAN address to be `192.168.1.1` - this is needed to masquerade redirected traffic towards the proxy.

```

config redirect
option src      lan
option proto    tcp
option src_ip   !192.168.1.100
option src_dport 80
option dest_ip  192.168.1.100
option dest_port 3128
option target   DNAT

config redirect
option dest     lan
option proto    tcp
option src_dip  192.168.1.1
option dest_ip  192.168.1.100
option dest_port 3128
option target   SNAT

```

Transparent proxy rule (same host)

The rule below redirects all outgoing HTTP traffic from LAN through a proxy server listening at port 3128 on the router itself.

```

config redirect
option src      lan
option proto    tcp
option src_dport 80
option dest_port 3128

```

IPSec Passthrough

This example enables proper forwarding of IPSec traffic through the WAN.

```

AH protocol config rule
option src      wan
option dest     lan
option proto    ah
option target   ACCEPT # ESP protocol config rule

option src      wan
option dest     lan
option proto    esp
option target   ACCEPT

```

For some configurations you also have to open port 500/UDP.

```
# ISAKMP protocol
config rule
option src      wan
option dest     lan
option proto    udp
option src_port 500
option dest_port 500
option target   ACCEPT
```

Manual iptables Rules

You can specify traditional iptables rules, in the standard iptables UNIX command form, in an external file and included in the firewall config file. It is possible to use this process to include multiple files.

```
config include
option path /etc/firewall.user
config include
option path /etc/firewall.vpn
```

The syntax for the includes is Linux standard and therefore different from UCIs.

Firewall Management

After a configuration change, to rebuild the firewall rules, enter:

```
root@VA_router:/# /etc/init.d/firewall restart
```

Executing the following command will flush all rules and set the policies to ACCEPT on all standard chains:

```
root@VA_router:/#/etc/init.d/firewall stop
```

To manually start the firewall, enter:

```
root@VA_router:/# /etc/init.d/firewall start
```

To permanently disable the firewall, enter:

```
root@VA_router:/# /etc/init.d/firewall disable
```



NOTE

Disable does not flush the rules, so you might be required to issue a stop before.

To enable the firewall again, enter:

```
root@VA_router:/# /etc/init.d/firewall enable
```

Debug Generated Rule Set

It is possible to observe the iptables commands generated by the firewall programme. This is useful to track down iptables errors during firewall restarts or to verify the outcome of certain UCI rules.

To see the rules as they are executed, run the `fw` command with the `FW_TRACE` environment variable set to **1**:

```
root@VA_router:/# FW_TRACE=1 fw reload
```

To direct the output to a file for later inspection, enter:

```
root@VA_router:/# FW_TRACE=1 fw reload 2> /tmp/iptables.lo
```

32. Configuring IPsec

Internet Protocol Security (IPsec) is a protocol suite used to secure communications at IP level. Use IPsec to secure communications between two hosts or between two networks. Merlin routers implement IPsec using strongSwan software.

If you need to create an IPsec template for DMVPN, read the chapter 'Dynamic Multipoint Virtual Private Network (DMVPN)'.

The number of IPsec tunnels supported by your router is not limited in any way by software; the only hardware limitation is the amount of RAM installed on the device.

Configuration package used

Package	Sections
strongswan	general
	connection
	secret

32.1. Configuring IPsec Using The Web Interface

To configure IPsec using the web interface, in the top menu, select **Services -> IPsec**. The strongSwan IPsec VPN page appears. There are three sections:

Common Settings	Control the overall behaviour of strongSwan. This behaviour is common across all tunnels.
Connection Settings	Together, these sections define the required parameters for a two-way IKEv1 tunnel.
Secret Settings	

32.1.1. Configure Common Settings Using The Web Interface

strongSwan IPsec VPN
Configuration of the strongSwan IPsec VPN system.

Enable StrongSwan IPsec

Strict CRL Policy Defines if a fresh CRL must be available in order for the peer authentication based on RSA signatures to succeed. IKEv2 additionally recognizes 'fun' which reverts to 'yes' if at least one CRL URI is defined and to 'no' if no URI is known.

Unique IDs Whether a particular participant ID should be kept unique, with any new (automatically keyed) connection using an ID from a different IP address deemed to replace all old ones using that ID. Participant IDs normally are unique, so a new (automatically-keyed) connection using the same ID is almost invariably intended to replace an old one. The IKEv2 daemon also accepts the value 'replace' which is identical to 'yes' and the value 'keep' to reject new IKE SA setups and keep the duplicate established earlier.

Cache CRLs CRLs fetched via HTTP or LDAP will be cached.

Disable Revocation (CRL and OCSP)

Send INITIAL CONTACT by default Send INITIAL CONTACT notification when first connection attempt for all connections

Debug

The common settings section

Web Field/UCI/Package Option	Description								
Web: Enable strongswan UCI: strongswan.general.enable Opt: enabled	Enables or disables IPsec. <table border="1"> <tr><td>0</td><td>Disabled</td></tr> <tr><td>Default: 1</td><td>Enabled</td></tr> </table>	0	Disabled	Default: 1	Enabled				
0	Disabled								
Default: 1	Enabled								
Web: Strict CRL Policy UCI: strongswan.general.strictcrlpolicy Opt: strictcrlpolicy	Defines if a fresh CRL must be available for the peer authentication based on RSA signatures to succeed. <table border="1"> <tr><td>0</td><td>Disabled</td></tr> <tr><td>Default: 1</td><td>Enabled</td></tr> </table>	0	Disabled	Default: 1	Enabled				
0	Disabled								
Default: 1	Enabled								
Web: Unique IDs UCI: strongswan.general.uniqueids Opt: uniqueids	Defines whether a particular participant ID should be kept unique, with any new, automatically keyed, connection using an ID from a different IP address deemed to replace all old ones using that ID. Participant IDs normally are unique, so a new, automatically- keyed, connection using the same ID is almost invariably intended to replace an old one. <table border="1"> <tr><td>0</td><td>Disabled</td></tr> <tr><td>Default: 1</td><td>Enabled</td></tr> </table>	0	Disabled	Default: 1	Enabled				
0	Disabled								
Default: 1	Enabled								
Web: Cache CRLs UCI: strongswan.general.cachecrls Opt: cachecrls	Certificate Revocation Lists (CRLs) fetched via HTTP or LDAP will be cached in /etc/ipsec.d/crls/ under a unique file name derived from the certification authority's public key. <table border="1"> <tr><td>0</td><td>Disabled</td></tr> <tr><td>Default: 1</td><td>Enabled</td></tr> <tr><td>replace</td><td>Identical to Yes</td></tr> <tr><td>keep</td><td>Rejects new IKE SA and keeps the duplicate established earlier</td></tr> </table>	0	Disabled	Default: 1	Enabled	replace	Identical to Yes	keep	Rejects new IKE SA and keeps the duplicate established earlier
0	Disabled								
Default: 1	Enabled								
replace	Identical to Yes								
keep	Rejects new IKE SA and keeps the duplicate established earlier								
Web: Disable Revocation UCI: strongswan.general.revocation_disabled Opt: revocation_disabled	Defines whether disable CRL and OCSP checking for revoked certificates. <table border="1"> <tr><td>0</td><td>Disabled</td></tr> <tr><td>Default: 1</td><td>Enabled</td></tr> </table>	0	Disabled	Default: 1	Enabled				
0	Disabled								
Default: 1	Enabled								
Web: Send INITIAL CONTACT by default UCI: strongswan.general.initial_contact	Defines whether the first attempt to contact a remote peer by this strongswan instance sets the initial_contact flag, which should cause compliant peers to automatically bring down any previous sessions. This can also be enabled or disabled per connection.								

Web Field/UCI/Package Option	Description						
Opt: initial_contact							
Web: Debug UCI: strongswan.general.debug Opt: debug	<p>Enables debugging. This option is used for trouble shooting issues. It is not suitable for a production environment.</p> <table border="1"> <tr> <td>Default: None</td> <td>Debug disabled</td> </tr> <tr> <td>Control</td> <td>Debug enabled. Shows generic control flow with errors and very basic auditing logs.</td> </tr> <tr> <td>All</td> <td>Debug enabled. Most verbose logging also includes sensitive information such as keys.</td> </tr> </table>	Default: None	Debug disabled	Control	Debug enabled. Shows generic control flow with errors and very basic auditing logs.	All	Debug enabled. Most verbose logging also includes sensitive information such as keys.
Default: None	Debug disabled						
Control	Debug enabled. Shows generic control flow with errors and very basic auditing logs.						
All	Debug enabled. Most verbose logging also includes sensitive information such as keys.						

32.1.2. Common Settings: Configure Connection Using Web Interface

Connections Delete

Enabled

Aggressive Mode

Name

Autostart Action
Operation on startup. **add** loads a connection without starting it. **route** loads a connection and installs kernel traps. If traffic is detected between local and remote, a connection is established **start** loads a connection and brings it up immediately. **ignore** do nothing

Connection Type

The configure connection page

Web Field/UCI/Package Option	Description										
Web: Enabled UCI: strongswan.@connection[X].enabled Opt: enable	Enables or disables an IPSec connection. <table border="1"> <tr> <td>Default: 0</td> <td>Disabled</td> </tr> <tr> <td>1</td> <td>Enabled</td> </tr> </table>	Default: 0	Disabled	1	Enabled						
Default: 0	Disabled										
1	Enabled										
Web: Aggressive UCI: strongswan.@connection[X].aggressive Opt: aggressive	Enables or disables IKE aggressive mode. Note: using aggressive mode along with PSK authentication is a less secure method than main mode and should be avoided. <table border="1"> <tr> <td>Default: 0</td> <td>Disabled</td> </tr> <tr> <td>1</td> <td>Enabled</td> </tr> </table>	Default: 0	Disabled	1	Enabled						
Default: 0	Disabled										
1	Enabled										
Web: Name UCI: strongswan.@connection[X].name Opt: name	Specifies a name for the tunnel.										
Web: Autostart Action UCI: strongswan.@connection[X].auto Opt: auto	Specifies when the tunnel is initiated. <table border="1"> <tr> <td>start</td> <td>On start up.</td> </tr> <tr> <td>Default: route</td> <td>When traffic routes this way.</td> </tr> <tr> <td>add</td> <td>Loads a connection without starting it.</td> </tr> <tr> <td>ignore</td> <td>Ignores the connection.</td> </tr> <tr> <td>always</td> <td>Actively retries to establish the tunnel if it went down.</td> </tr> </table>	start	On start up.	Default: route	When traffic routes this way.	add	Loads a connection without starting it.	ignore	Ignores the connection.	always	Actively retries to establish the tunnel if it went down.
start	On start up.										
Default: route	When traffic routes this way.										
add	Loads a connection without starting it.										
ignore	Ignores the connection.										
always	Actively retries to establish the tunnel if it went down.										
Web: Connection Type UCI: strongswan.@connection[X].type Opt: type	Defines the type of IPSec connection. <table border="1"> <tr> <td>Default: tunnel</td> <td>Connection uses tunnel mode.</td> </tr> <tr> <td>transport</td> <td>Connection uses transport mode.</td> </tr> <tr> <td>pass</td> <td>Connection does not perform any IPSec processing</td> </tr> <tr> <td>drop</td> <td>Connection drops all the packets</td> </tr> </table>	Default: tunnel	Connection uses tunnel mode.	transport	Connection uses transport mode.	pass	Connection does not perform any IPSec processing	drop	Connection drops all the packets		
Default: tunnel	Connection uses tunnel mode.										
transport	Connection uses transport mode.										
pass	Connection does not perform any IPSec processing										
drop	Connection drops all the packets										

32.1.3. Common Settings: IP Addressing Using The Web Interface

Connection Type: tunnel
 Remote GW Address: 89.501.154.151 Could be IP address or FQDN or '%any'
 Local Id: 182.162.206.1 Leave blank to use default (local interface IP address)
 Remote Id: 89.501.154.151 Leave blank to use default (remote gateway IP address)
 Local LAN IP Address: 192.156.206.1
 Local LAN IP Address Mask: 258.258.255.255
 Remote LAN IP Address: 172.255.255.255
 Remote LAN IP Address Mask:
 Local Protocol: Restrict the traffic selector to a single protocol on the local side
 Local Port: Restrict the traffic selector to a single UDP/TCP port on the local side
 Remote Protocol: Restrict the traffic selector to a single protocol on the remote side
 Remote Port: Restrict the traffic selector to a single UDP/TCP port on the remote side
 Authby: psk How the two security gateways should authenticate each other.
 XAuth identity: Defines the identity/username the client uses to reply to an XAuth request. If not defined, the IKEv1 identity will be used as XAuth identity.

The IP addressing settings

Web Field/UCI/Package Option	Description						
Web: Remote GW Address UCI: strongswan.@connection[X].remoteaddress Opt: remoteaddress	Sets the public IP address of the remote peer.						
Web: Local ID UCI: strongswan.@connection[X].localid Opt: localid	Defines the local peer identifier.						
Web: Remote ID UCI: strongswan.@connection[X].remoteid Opt:remoteid	Defines the remote peer identifier.						
Web: Local LAN IP Address UCI: strongswan.@connection[X].locallan Opt: locallan	Defines the local IP of LAN.						
Web: Local LAN IP Address Mask UCI: strongswan.@connection[X].locallanmask Opt: locallanmask	Defines the subnet of local LAN.						
Web: Remote LAN IP Address UCI: strongswan.@connection[X].remotelan Opt:remotelan	Defines the IP address of LAN serviced by remote peer.						
Web: Remote LAN IP Address Mask UCI: strongswan.@connection[X].remotelanmask Opt:remotelanmask	Defines the Subnet of remote LAN.						
Web: Local Protocol UCI: strongswan.@connection[X].localproto Opt: localproto	Restricts the connection to a single port on the local side.						
Web: Local Port UCI: strongswan.@connection[X].localport Opt: localport	Restricts the connection to a single protocol on the local side.						
Web: Remote Protocol UCI: strongswan.@connection[X].remoteproto Opt: remoteproto	Restricts the connection to a single protocol on the remote side.						
Web: Remote Port UCI: strongswan.@connection[X].remoteport Opt: remoteport	Restricts the connection to a single port on the remote side.						
Web: Authby UCI: strongswan.@connection[X].authby Opt: authby	Defines how the two secure gateways should authenticate. Note: using aggressive mode along with PSK authentication is unsecure and should be avoided. <table border="1" data-bbox="667 1921 1398 2024"> <tbody> <tr> <td>Pubkey</td> <td>For public key signatures.</td> </tr> <tr> <td>Rsasig</td> <td>For RSA digital signatures.</td> </tr> <tr> <td>ecdsasig</td> <td>For elliptic curve DSA signatures.</td> </tr> </tbody> </table>	Pubkey	For public key signatures.	Rsasig	For RSA digital signatures.	ecdsasig	For elliptic curve DSA signatures.
Pubkey	For public key signatures.						
Rsasig	For RSA digital signatures.						
ecdsasig	For elliptic curve DSA signatures.						

Web Field/UCI/Package Option	Description	
	Psk	Using a preshared key.
	zauthrsasig	Enables eXtended Authentication (ZAtuh) with addition to RSA signatures.
	zauthpsk	Using extended authentication and preshared key.
	never	Can be used if negotiation is never to be attempted or accepted (shunt connection)

32.2. Common Settings: IPSec Settings Using The Web Interface

XAuth identity Defines the identity/username the client uses to reply to an XAuth request. If not defined, the IKEv1 identity will be used as XAuth identity.

Reauthenticate Reauthenticate the peer at every rekeying of the IKE_SA

IKE algorithm

ESP algorithm

WAN Interface

IKE life time How long the keying channel of a connection should last before being renegotiated.

Key life Synonym for lifetime. How long a particular instance of a connection (a set of encryption/authentication keys for user packets) should last, from successful negotiation to expiry.

Rekey margin Synonym for margintime. How long before connection expiry or keying-channel expiry should attempts to negotiate a replacement begin.

Keying tries How many attempts (a positive integer or %forever) should be made to negotiate a connection, or a replacement for one, before giving up (default 3). The value %forever means 'never give up'.

Restart delay Delay termination of previous IKE SA and start of the next IKE SA of automatic connection. If 0 then random delay in the range of 1 to Rekey margin is used

DPD Action Controls the use of the DPD protocol where R_U_THERE notification messages (IKEv1) or empty INFORMATIONAL messages (IKEv2) are periodically sent in order to check the liveliness of the IPsec peer. If no activity is detected, all connections with a dead peer are stopped and unrouted (clear, put in the hold state (hold) or restarted (restart). The default is none which disables the active sending of DPD messages.

DPD Delay Defines the period time interval with which R_U_THERE messages/INFORMATIONAL exchanges are sent to the peer.

DPD Timeout Defines the timeout interval, after which all connections to a peer are deleted in case of inactivity.

Inherit CHILD SA Inherit CHILD SA when IKE SA is rekeyed

Send INITIAL CONTACT Send INITIAL CONTACT notification when first connection attempt

The common settings: IPSec settings page

Figure 5. Common settings: IPSec settings

Web Field/UCI/Package Option	Description
Web: XAuth Identity UCI: strongswan.@connection[X].xauth_identity Opt: xauth_identity	Defines Xauth ID.
Web: IKE Algorithm UCI: strongswan.@connection[X].ike Opt: ike	Specifies the IKE algorithm to use. The format is: encAlgo authAlgo DHGroup encAlgo: 3des aes128 aes256 serpent twofish blowfish authAlgo: md5 sha sha2 DHGroup: modp1024 modp1536 modp2048 modp3072 modp4096 modp6144 modp8192 For example, a valid IKE algorithm is: aes128-sha-modp1536.
Web: ESP algorithm UCI: strongswan.@connection[X].esp Opt: esp	Specifies the esp algorithm to use. encAlgo: 3des aes128 aes256 serpent twofish blowfish authAlgo: md5 sha sha2 DHGroup: modp1024 modp1536 modp2048 modp3072 modp4096 modp6144

Web Field/UCI/Package Option	Description								
	<p>modp8192</p> <p>For example, a valid IKE algorithm is: aes128-sha-modp1536.</p>								
<p>Web: WAN Interface</p> <p>UCI: strongswan.@connection[X].waniface</p> <p>Opt: waniface</p>	<p>This is a space-separated list of the WAN interfaces the router will use to establish a tunnel with the secure gateway.</p> <p>On the web, a list of the interface names is automatically generated. If you want to specify more than one interface use the "custom" value.</p> <p>Example: if you have a 3G WAN interface called 'wan' and a WAN ADSL interface called 'dsl' and wanted to use one of these interfaces for this IPSec connection, you would use: 'wan adsl'.</p>								
<p>Web: IKE Life Time</p> <p>UCI: strongswan.@connection[X].ikelifetime</p> <p>Opt: ikelifetime</p>	<p>Specifies how long the keying channel of a connection (ISAKMP or IKE SA) should last before being renegotiated.</p> <table border="1"> <tr> <td>Default:</td> <td>3 hr</td> </tr> <tr> <td>Timespec</td> <td>1d, 1h, 25m, 10s</td> </tr> </table>	Default:	3 hr	Timespec	1d, 1h, 25m, 10s				
Default:	3 hr								
Timespec	1d, 1h, 25m, 10s								
<p>Web: Key Life</p> <p>UCI: strongswan.@connection[X].keylife</p> <p>Opt: keylife</p>	<p>Specifies how long a particular instance of a connection (a set of encryption/authentication keys for user packets) should last, from successful negotiation to expiry.</p> <p>Normally, the connection is renegotiated (via the keying channel) before it expires (see rekeymargin).</p> <table border="1"> <tr> <td>Default:</td> <td>1h</td> </tr> <tr> <td>Timespec</td> <td>1d, 1h, 25m, 10s</td> </tr> </table>	Default:	1h	Timespec	1d, 1h, 25m, 10s				
Default:	1h								
Timespec	1d, 1h, 25m, 10s								
<p>Web: Rekey Margin</p> <p>UCI: strongswan.@connection[X].rekeymargin</p> <p>Opt: rekeymargin</p>	<p>Specifies how long before connection expiry or keying- channel expiry should attempt to negotiate a replacement begin.</p> <p>Relevant only locally, other end need not agree on it.</p> <table border="1"> <tr> <td>Default:</td> <td>9m</td> </tr> <tr> <td>Timespec</td> <td>1d, 2h, 9m, 10s</td> </tr> </table>	Default:	9m	Timespec	1d, 2h, 9m, 10s				
Default:	9m								
Timespec	1d, 2h, 9m, 10s								
<p>Web: Restart Delay</p> <p>UCI: strongswan.@connection[X].restartdelay</p> <p>Opt: restartdelay</p>	<p>Defines specific delay when re-establishing a connection. Previously if <code>close_action=restart</code>, then the new option <code>restartdelay</code> controls how many seconds it waits before attempting to re-establish the tunnel to allow the headend some time to tidy up.</p> <p>If not set, it defaults to zero, which means that the previous behaviour of choosing a random time interval in the range 0 . . <code>RekeyMargin</code> seconds takes effect.</p> <p>Relevant only locally, other end need not agree on it.</p> <table border="1"> <tr> <td>Default:</td> <td>0</td> </tr> <tr> <td>Timespec</td> <td>1d, 2h, 9m, 10s</td> </tr> </table>	Default:	0	Timespec	1d, 2h, 9m, 10s				
Default:	0								
Timespec	1d, 2h, 9m, 10s								
<p>Web: Keying Tries</p> <p>UCI: strongswan.@connection[X].keyingtries</p> <p>Opt: keyingtries</p>	<p>Specifies how many attempts, for example, a positive integer or %forever, should be made to negotiate a connection, or a replacement for one, before giving up. The value %forever means 'never give up'.</p> <p>Relevant only locally, the other end need not agree on it.</p>								
<p>Web: DPD Action</p> <p>UCI: strongswan.@connection[X].dpdaction</p> <p>Opt: dpdaction</p>	<p>Defines DPD (Dead Peer Detection) action.</p> <table border="1"> <tr> <td>Default: None</td> <td>Disables DPD.</td> </tr> <tr> <td>Clear</td> <td>Clear down the tunnel if peer does not respond. Reconnect when traffic brings the tunnel up.</td> </tr> <tr> <td>Hold</td> <td>Clear down the tunnel and bring up as soon as the peer is available.</td> </tr> <tr> <td>Restart</td> <td>Restarts DPD when no activity is detected.</td> </tr> </table>	Default: None	Disables DPD.	Clear	Clear down the tunnel if peer does not respond. Reconnect when traffic brings the tunnel up.	Hold	Clear down the tunnel and bring up as soon as the peer is available.	Restart	Restarts DPD when no activity is detected.
Default: None	Disables DPD.								
Clear	Clear down the tunnel if peer does not respond. Reconnect when traffic brings the tunnel up.								
Hold	Clear down the tunnel and bring up as soon as the peer is available.								
Restart	Restarts DPD when no activity is detected.								
<p>Web: DPD Delay</p> <p>UCI: strongswan.@connection[X].dpddelay</p> <p>Opt: dpddelay</p>	<p>Defines the period time interval with which R_U_THERE messages and INFORMATIONAL exchanges are sent to the peer.</p> <p>These are only sent if no other traffic is received.</p> <table border="1"> <tr> <td>Default:</td> <td>30s</td> </tr> <tr> <td>Timespec</td> <td>1d, 2h, 25m, 10s</td> </tr> </table>	Default:	30s	Timespec	1d, 2h, 25m, 10s				
Default:	30s								
Timespec	1d, 2h, 25m, 10s								
<p>Web: DPD Timeout</p> <p>UCI: strongswan.@connection[X].dpdtimeout</p> <p>Opt: dpdtimeout</p>	<p>Defines the timeout interval, after which all connections to a peer are deleted in case of inactivity.</p> <table border="1"> <tr> <td>Default:</td> <td>150s</td> </tr> <tr> <td>Timespec</td> <td>1d, 2h, 25m, 10s</td> </tr> </table>	Default:	150s	Timespec	1d, 2h, 25m, 10s				
Default:	150s								
Timespec	1d, 2h, 25m, 10s								
<p>Web: Inherit CHILD SA</p> <p>UCI:strongswan.@connection[X].inherit_child</p>	<p>Defines whether the existing phase two IPSEC SA is maintained through IKE rekey for this tunnel. This is normally set to match the behaviour on the IPSEC headend.</p>								

Web Field/UCI/Package Option	Description	
Opt: inherit_child	Default: 0	Delete the existing IPSEC SA on IKE rekey
	1	Maintain the existing IPSEC SA on IKE rekey
Web: Send INITIAL CONTACT UCI: strongswan.@connection[X].initial_contact Opt: initial_contact	Defines whether the first attempt to contact a remote peer by this strongswan instance sets the initial_contact flag which should cause compliant peers to automatically bring down any previous sessions.	
	Default: 0	Do not set initial contact flag
	1	Set initial contact flag on first attempt.

32.3. Configure Secret Settings Using The Web Interface

Each tunnel requires settings to configure how the local end point of the tunnel proves its identity to the remote end point.

Secrets

Enabled	ID selector	Secret Type	Secret
<i>To match local/remote ip enter local ip followed by space followed by remote ip</i>			
<input checked="" type="checkbox"/>	<input type="text" value="192.168.208.1 89.101.154.151"/>	psk ▼	<input type="text" value="secret"/> Delete
<input checked="" type="checkbox"/>	<input type="text" value="192.168.208.1 192.168.100.2"/>	psk ▼	<input type="text" value="secret"/> Delete
<input type="button" value="Add"/>			
<input type="button" value="Save & Apply"/> <input type="button" value="Save"/> <input type="button" value="Reset"/>			

The IPsec secret settings section

Figure 6. Configure secret settings

Web Field/UCI/Package Option	Description										
Web: Enabled UCI: strongswan.@secret[X].enabled Opt: enabled	Defines whether this set of credentials is to be used or not. <table border="1"> <tr> <td>Default: 0</td> <td>Disabled</td> </tr> <tr> <td>1</td> <td>Enabled</td> </tr> </table>	Default: 0	Disabled	1	Enabled						
Default: 0	Disabled										
1	Enabled										
Web: ID selector UCI: strongswan.@secret[X].idtype Opt: idtype	Defines whether IP address or userfqdn is used.										
Web: ID selector UCI: strongswan.@secret[X].localaddress Opt: localaddress	Defines the local address this secret applies to.										
Web: ID selector UCI: strongswan.@secret[X].remoteaddress Opt: remoteaddress	Defines the remote address this secret applies to.										
Web: N/A UCI: strongswan.@secret[X].userfqdn Opt: userfqdn	FQDN or Xauth name used of Extended Authentication. This must match xauth_identity from the configuration connection section.										
Web: Secret Type UCI: strongswan.@secret[X].secrettype Opt: secrettype	Specifies the authentication mechanism to be used by the two peers. <table border="1"> <tr> <td>Psk</td> <td>Preshared secret</td> </tr> <tr> <td>Pubkey</td> <td>Public key signatures</td> </tr> <tr> <td>Rsasig</td> <td>RSA digital signatures</td> </tr> <tr> <td>Ecdsasig</td> <td>Elliptic Curve DSA signatures</td> </tr> <tr> <td>Xauth</td> <td>Extended authentication</td> </tr> </table>	Psk	Preshared secret	Pubkey	Public key signatures	Rsasig	RSA digital signatures	Ecdsasig	Elliptic Curve DSA signatures	Xauth	Extended authentication
Psk	Preshared secret										
Pubkey	Public key signatures										
Rsasig	RSA digital signatures										
Ecdsasig	Elliptic Curve DSA signatures										
Xauth	Extended authentication										

32.4. Configuring An IPSec Template For DMVPN Via The Web Interface

To configure IPSec using the web interface, in the top menu, select **Services -> IPSec**. The strongSwan IPSec VPN page appears. There are three sections:

Common Settings	Control the overall behaviour of strongSwan. This behaviour is common across all tunnels.
Connection Settings	Together, these sections define the required parameters for a two-way IKEv1 tunnel.
Secret Settings	

32.5. Configuring IPSec Using UCI

Common Settings

```
# Commands
touch /etc/config/strongswan
uci set strongswan.general=general
uci set strongswan.general.enabled=yes
uci set strongswan.general.strictcrlpolicy=no
uci set strongswan.general.uniqueids=yes
uci set strongswan.general.cachecrls=no
uci set strongswan.general.debug=none
uci set strongswan.general.initial_contact=0
uci commit
```

Connection Settings



NOTE

Xauth is not supported in IKEv2.

```
touch /etc/config/strongswan

uci add strongswan connection

uci set strongswan.@connection[0].ikelifetime=3h
uci set strongswan.@connection[0].keylife=1h
uci set strongswan.@connection[0].rekeymargin=9m
uci set strongswan.@connection[0].keyingtries=3
uci set strongswan.@connection[0].restartdelay=0
uci set strongswan.@connection[0].dpdaction=none
uci set strongswan.@connection[0].dpddelay=30s
uci set strongswan.@connection[0].dpdtimeout=150s
uci set strongswan.@connection[0].enabled=yes
uci set strongswan.@connection[0].name=3G_Backup
uci set strongswan.@connection[0].auto=start
uci set strongswan.@connection[0].type=tunnel
uci set strongswan.@connection[0].remoteaddress=100.100.100.100
uci set strongswan.@connection[0].localid=192.168.209.1
uci set strongswan.@connection[0].remoteid=100.100.100.100
uci set strongswan.@connection[0].locallan=192.168.209.1
uci set strongswan.@connection[0].locallanmask=255.255.255.255
uci set strongswan.@connection[0].remotelan=172.19.101.3
uci set strongswan.@connection[0].remotelanmask=255.255.255.255
uci set strongswan.@connection[0].authby=xauthpsk
uci set strongswan.@connection[0].xauth_identity=testxauth
uci set strongswan.@connection[0].ike=3des-md5-modp1024
uci set strongswan.@connection[0].esp=3des-md5
uci set strongswan.@connection[0].waniface=wan
uci set strongswan.@connection[0].inherit_child=0
uci set strongswan.@connection[0].initial_contact=0

uci commit
```

This will create the following output:

```
config connection
option ikelifetime '3h'
option keylife '1h'
option rekeymargin '9m'
option keyingtries '3'
option restartdelay '0'
option dpdaction 'none'
option dpddelay '30s'
option dpdtimeout '150s'
option enabled 'yes'
option name '3G_Backup'
option auto 'start'
option type 'tunnel'
option remoteaddress '100.100.100.100 '
option localid '192.168.209.1'
option remoteid '100.100.100.100 '
option locallan '192.168.209.1'
option locallanmask '255.255.255.255'
option remotelan '172.19.101.3'
option remotelanmask '255.255.255.255'
option authby 'xauthpsk'
option xauth_identity 'testxauth'
option ike '3des-md5-modp1024'
option esp '3des-md5'
option waniface 'wan'
option inherit_child '0'
option initial_contact '0'
```

32.6. Shunt Connection Using UCI

If the remote LAN network is 0.0.0.0/0 then all traffic generated on the local LAN will be sent via the IPSec tunnel. This includes the traffic destined to the router's IP address. To avoid this situation you must include an additional config connection section.

```
# Commands

touch /etc/config/strongswan

uci add strongswan connection

uci set strongswan.@connection[1].name=local

uci set strongswan.@connection[1].enabled=yes

uci set strongswan.@connection[1].locallan=10.1.1.1

uci set strongswan.@connection[1].locallanmask=255.255.255.255

uci set strongswan.@connection[1].remotelan=10.1.1.0

uci set strongswan.@connection[1].remotelanmask=255.255.255.0

uci set strongswan.@connection[1].type=pass

uci set strongswan.@connection[1].auto=route

uci commit
```

This will create the following output:

```
config connection

option name 'local' option enabled 'yes'

option locallan '10.1.1.1'

option locallanmask '255.255.255.255'

option remotelan '10.1.1.0'

option remotelanmask '255.255.255.0' option type 'pass'

option auto 'route'
```

Traffic originated on `remotelan` and destined to `locallan` address is excluded from VPN IPsec policy.

32.7. Secret Settings Using UCI

Each tunnel also requires settings for how the local end point of the tunnel proves its identity to the remote end point.

A sample secret section, which could be used with the connection section in 'Connection Settings', is shown below.

```
# Commands to add a secret for psk auth

touch /etc/config/strongswan

uci add strongswan secret

uci set strongswan.@secret[0].enabled=yes

uci set strongswan.@secret[0].localaddress=192.168.209.1

uci set strongswan.@secret[0].remoteaddress= 100.100.100.100

uci set strongswan.@secret[0].secrettype=psk

uci set strongswan.@secret[0].secret=secret

uci commit
```

This will create the following output:

```
config secret
option enabled 'yes'
option localaddress '192.168.209.1'
option remoteaddress '100.100.100.100 '
option secrettype 'psk'
option secret 'secret'
```

If `xauth` is defined as the authentication method then you must include an additional `config secret` section, as shown in the example below.

```
# Commands to add a secret for xauth auth touch /etc/config/strongswan
uci add strongswan secret
uci set strongswan.@secret[1].enabled=yes
uci set strongswan.@secret[1].idtype=userfqdn uci set strongswan.@secret[1].userfqdn=testxauth
uci set strongswan.@secret[1].remoteaddress=100.100.100.100 uci set strongswan.@secret[1].secret=xauth
uci set strongswan.@secret[1].secrettype=XAUTH
uci commit
```

This will create the following output:

```
config secret
option enabled 'yes'
option idtype 'userfqdn'
option userfqdn 'testxauth'
option remoteaddress '100.100.100.100'
option secret 'xauth'
option secrettype 'XAUTH'
```

32.8. Configuring An IPSec Template To Use With DMVPN Using UCI

The following example shows how to configure an IPSec connection template to use with DMVPN.

```
# Commands

touch /etc/config/strongswan

uci set strongswan.general=general

uci set strongswan.general.enabled=yes

uci set strongswan.general.strictcrpolicys=no

uci set strongswan.general.uniqueids=yes

uci set strongswan.general.cachecrls=yes

uci set strongswan.general.nat traversal=yes
```

```
uci add strongswan connection

uci set strongswan.@connection[0].enabled=yes

uci set strongswan.@connection[0].name=dmpvpn

uci set strongswan.@connection[0].type=transport

uci set strongswan.@connection[0].localproto=gre

uci set strongswan.@connection[0].remoteproto=gre

uci set strongswan.@connection[0].ike=aes-sha1-modp1024

uci set strongswan.@connection[0].esp=aes128-sha1

uci set strongswan.@connection[0].waniface=lan4

uci set strongswan.@connection[0].auto=ignore

uci set strongswan.@connection[0].ikelifetime=28800s

uci set strongswan.@connection[0].keylife=300s

uci set strongswan.@connection[0].rekeymargin=30s

uci set strongswan.@connection[0].keyingtries=%forever

uci set strongswan.@connection[0].dpdaction=hold

uci set strongswan.@connection[0].dpddelay=30s

uci set strongswan.@connection[0].dpdtimeout=150s
```

```
uci add strongswan secret

uci set strongswan.@secret[0].enabled=yes

uci set strongswan.@secret[0].secrettype=psk

uci set strongswan.@secret[0].secret=secret
```

This will create package strongswan.

```

config general 'general'

option enabled 'yes'

option strictcrtpolicy 'no'

option uniqueids 'yes'

option cachecrls 'yes'

option nattraversal 'yes'

config connection

option enabled 'yes'

option name 'dmvpn'

option type 'transport'

option localproto 'gre'

option remoteprototo 'gre'

option ike 'aes-sha1-modp1024'

option esp 'aes128-sha1'

option waniface 'lan4'

option auto 'ignore'

option ikelifetime '28800s'

option keylife '300s'

option rekeymargin '30s'

option keyingtries '%forever'

option dpdaction 'hold'

option dpddelay '30s'

option dpdtimeout '150s' config secret

option enabled 'yes'

option secrettype 'psk'

option secret 'secret'

```

32.9. IPSec Diagnostics

IPSec Status using the Web Interface

In the top menu, click **Status -> IPSec**. The IPSec Connections page appears.

IPsec Connections									
Name	IKE					SA			
	Status	Remote	Established	Encryption	Integrity	Status	Policy	Data In/Out	Rekey in
dmvpn_213_233_148_2	ESTABLISHED	213.233.148.2	2 hours ago	3DES_CBC	HMAC_MD5_96	INSTALLED			
dmvpn_89_101_154_151	ESTABLISHED	89.101.154.151	2 hours ago	3DES_CBC	HMAC_MD5_96	INSTALLED			

The IPSec connections page

In the Name column, the syntax contains the IPsec Name defined in package dmvpn and the remote IP address of the hub, or the spoke separated by an underscore; for example, dmvpn_213.233.148.2.

IPsec Diagnostics using UCI

Viewing IPsec Configuration

To view IPsec configuration via UCI, enter:

```
root@VA_router:~# uci export strongswan
```

To restart strongSwan, enter:

```
root@VA_router:~# /etc/init.d/strongswan restart
```

IPsec Status

```
root@VA_router:~# ipsec statusall
Security Associations (1 up, 0 connecting):
dmvpn_89_101_154_151[1]: ESTABLISHED 2 hours ago,
10.68.234.133[10.68.234.133], 89.101.154.151[89.101.154.151]
dmvpn_89_101_154_151{1}: REKEYING, TRANSPORT, expires in 55 seconds
dmvpn_89_101_154_151{1}: 10.68.234.133/32[gre] === 192.168./32[gre]
dmvpn_89_101_154_151{1}: INSTALLED, TRANSPORT, ESP in UDP SPIs: cca7b970_i
d874dc90_o
dmvpn_89_101_154_151{1}: 10.68.234.133/32[gre] === 89.101.154.151/32[gre]
```

To view a list of IPsec commands, enter:

```
root@VA_router:~# ipsec -help
```

33. Configuring SCEP (Simple Certificate Enrolment Protocol)

SCEP is a method for automatically obtaining x.509 certificates for IPSec validation. This protocol is commonly used in a Private Key Infrastructure (PKI).

The SCEP method has the following steps:

- Obtain a copy of the Certificate Authority (CA) certificate and validate it.
- Generate a Certificate Signing Request (CSR) and send it securely to the CA.
- Re-enrol as necessary to obtain a new certificate prior to the expiration of the current certificate.

This section only details the SCEP portion of an IPSec configuration. For more information on configuring general IPSec, read the chapter 'Configuring IPSec'.

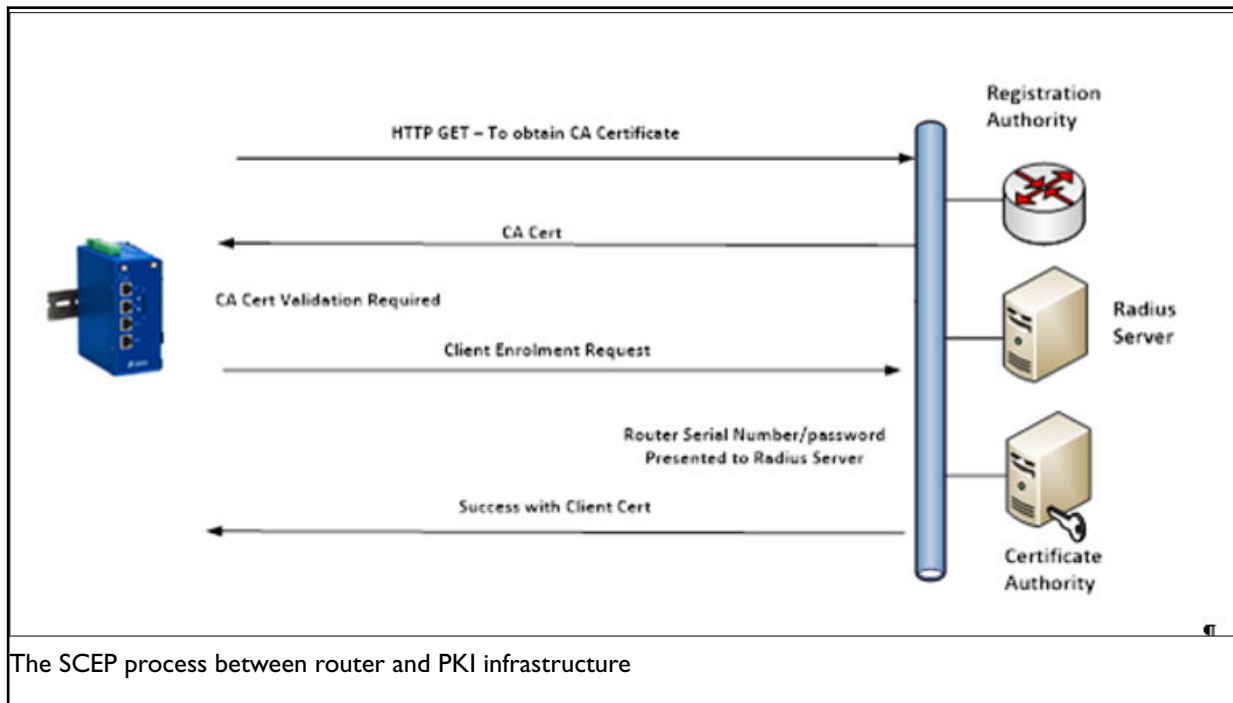

Configuration package used

Package	Sections
strongswan	scep_cert

33.1. Configuring SCEP Using The Web Interface

To define an automatically enrolled certificate, using SCEP, select **Services -> IPSec**. Scroll down to the SCEP Certificate section. Enter a name for the SCEP section and select **Add**.

SCEP Certificate

SCEP works only on boot

This section contains no values yet

SCEP certificate name section

The SCEP certificate configuration section options appear.

SCEPCERT

Enabled

Blocking Don't start IPsec until certificate is received

SCEP URL SCEP server URL

SCEP DN Distinguished Name

SCEP Password

Certificate Path Location to store certificate on the router (defaults to /etc/ipsec.d/certs/.pem)

Private Key Path Location to store private key on the router (defaults to /etc/ipsec.d/private/.pem)

CA Certificate Path Location to store CA certificate on the router

Minimal Renew Margin (in Hours) Renew certificate not less than Minimal Renew Margin hours before expiration

Maximal Renew Margin (in Hours) Renew certificate not more than Maximal Renew Margin hours before expiration

Minimal Retry Interval (in Seconds) Minimal SCEP poll time

Maximal Retry Interval (in Seconds) Maximal SCEP poll time

Private Key Length (in bits)

HTTP Method

PKCS#7 Encryption Algorithm

PKCS#7 Digest Algorithm

PKCS#10 Signature Algorithm

CA Implementation Force certain CA implementation. Leave blank unless you're doing

The SCEP certificate section options

Web Field/UCI/Package Option	Description				
Web: Enabled UCI: strongswan.@scep_cert[0].enabled Opt: enabled	Defines whether SCEP automatic enrolment is enabled. <table border="1"> <tr> <td>0</td> <td>Disabled</td> </tr> <tr> <td>Default: 1</td> <td>Enabled</td> </tr> </table>	0	Disabled	Default: 1	Enabled
0	Disabled				
Default: 1	Enabled				
Web: Blocking UCI: strongswan.@scep_cert[0].blocking Opt: blocking	Defines whether to wait until the certificate is received before starting IPsec. <table border="1"> <tr> <td>Default: 0</td> <td>Wait until the certificate is received before starting IPsec.</td> </tr> <tr> <td>1</td> <td>Do not wait until the certificate is received.</td> </tr> </table>	Default: 0	Wait until the certificate is received before starting IPsec.	1	Do not wait until the certificate is received.
Default: 0	Wait until the certificate is received before starting IPsec.				
1	Do not wait until the certificate is received.				
Web: SCEP URL UCI: strongswan.@scep_cert[0].url Opt: url	Defines the URL for the SCEP server.				
Web: SCEP DN UCI: strongswan.@scep_cert[0].dn Opt: dn	Defines the Distinguished Name to use for new certificate. Note: substring %serial will be replaced with a router's serial number.				
Web: SCEP Password UCI: strongswan.@scep_cert[0].scep_psk Opt: scep_psk	Defines a SCEP password.				
Web: Certificate Path UCI: strongswan.@scep_cert[0].cert_path Opt: cert_path	Defines the filepath to store the certificate on the router (absolute or relative). <table border="1"> <tr> <td>Default: Empty</td> <td>/etc/ipsec.d/certs/.pem</td> </tr> </table>	Default: Empty	/etc/ipsec.d/certs/.pem		
Default: Empty	/etc/ipsec.d/certs/.pem				
Web: Private Key Path UCI: strongswan.@scep_cert[0].key_path Opt: key_path	Defines the filepath to store the private key on the router (absolute or relative). <table border="1"> <tr> <td>Default: Empty</td> <td>/etc/ipsec.d/certs/.pem</td> </tr> </table>	Default: Empty	/etc/ipsec.d/certs/.pem		
Default: Empty	/etc/ipsec.d/certs/.pem				
Web: CA Certificate Path UCI: strongswan.@scep_cert[0].cacert Opt: cacert	Defines the filepath to store the CA certificate on the router (absolute or relative). <table border="1"> <tr> <td>Default: Empty</td> <td>/etc/ipsec.d/certs/.pem</td> </tr> </table>	Default: Empty	/etc/ipsec.d/certs/.pem		
Default: Empty	/etc/ipsec.d/certs/.pem				
Web: Minimal Renewal Margin (Hours) UCI: strongswan.@scep_cert[0].minmargin_hrs Opt: minmargin_hrs	Defines the minimum duration, in hours, from certificate expiration for renewal of certificate. Note: a random value between minimal and maximal renewal margin will be used. <table border="1"> <tr> <td>Default:</td> <td>10 hours</td> </tr> </table>	Default:	10 hours		
Default:	10 hours				
Web: Maximal Renewal Margin (Hours) UCI: strongswan.@scep_cert[0].maxmargin_hrs Opt: maxmargin_hrs	Defines the maximum duration, in hours, from certificate expiration for renewal of certificate. Note: the retry interval will be set to a random value between minimal and maximal renewal margin. <table border="1"> <tr> <td>Default:</td> <td>24 hours</td> </tr> </table>	Default:	24 hours		
Default:	24 hours				
Web: Minimal Retry Interval (Seconds) UCI: strongswan.@scep_cert[0].minretry Opt: minretry	Defines the minimal poll time, in seconds. Note: the retry interval will be set to a random value between minimal and maximal renewal margin. The retry interval is used when the server replies with PENDING status for initial request (also called manual mode). <table border="1"> <tr> <td>Default:</td> <td>10 hours</td> </tr> </table>	Default:	10 hours		
Default:	10 hours				
Web: Maximal Retry Interval (Seconds) UCI: strongswan.@scep_cert[0].maxretry	Defines the maximal poll time, in seconds.				

Web Field/UCI/Package Option	Description																		
Opt: maxretry	<p>Note: the retry interval will be set to a random value between minimal and maximal renewal margin. The retry interval is used when the server replies with PENDING status for initial request (also called manual mode).</p> <table border="1"> <tr> <td>Default:</td> <td>100 seconds</td> </tr> </table>	Default:	100 seconds																
Default:	100 seconds																		
Web: Private Key Length (in bits) UCI: strongswan.@scep_cert[0].key_len Opt: key_len	Defines the private key length. <table border="1"> <tr> <td>Default: 2048</td> <td>2048 bits</td> </tr> <tr> <td>4096</td> <td>4096 bits</td> </tr> <tr> <td>6144</td> <td>6144 bits</td> </tr> <tr> <td>8192</td> <td>8192 bits</td> </tr> <tr> <td>--custom--</td> <td>Defines custom length</td> </tr> </table>	Default: 2048	2048 bits	4096	4096 bits	6144	6144 bits	8192	8192 bits	--custom--	Defines custom length								
Default: 2048	2048 bits																		
4096	4096 bits																		
6144	6144 bits																		
8192	8192 bits																		
--custom--	Defines custom length																		
Web: HTTP Method UCI: strongswan.@scep_cert[0].method Opt: method	Defines the HTTP method used for client enrolment. <table border="1"> <thead> <tr> <th>Web</th> <th>Description</th> <th>UCI</th> </tr> </thead> <tbody> <tr> <td>Default: GET</td> <td>HTTP GET</td> <td>get</td> </tr> <tr> <td>POST</td> <td>HTTP POST</td> <td>post</td> </tr> </tbody> </table>	Web	Description	UCI	Default: GET	HTTP GET	get	POST	HTTP POST	post									
Web	Description	UCI																	
Default: GET	HTTP GET	get																	
POST	HTTP POST	post																	
Web: PKCS#7 Encryption Algorithm UCI: strongswan.@scep_cert[0].pkcs7_enc_algo Opt: pkcs7_enc_algo	Defines the symmetric encryption algorithm to use. <table border="1"> <thead> <tr> <th>Web</th> <th>Description</th> <th>UCI</th> </tr> </thead> <tbody> <tr> <td>Default: aes256</td> <td></td> <td>aes256</td> </tr> <tr> <td>aes192</td> <td></td> <td>aes192</td> </tr> <tr> <td>aes128</td> <td></td> <td>aes128</td> </tr> <tr> <td>3des</td> <td></td> <td>3des</td> </tr> </tbody> </table>	Web	Description	UCI	Default: aes256		aes256	aes192		aes192	aes128		aes128	3des		3des			
Web	Description	UCI																	
Default: aes256		aes256																	
aes192		aes192																	
aes128		aes128																	
3des		3des																	
Web: PKCS#7 Digest Algorithm UCI: strongswan.@scep_cert[0].pkcs7_dgst_algo Opt: pkcs7_dgst_algo	Defines the hash algorithm for pkcs7 digest calculation. <table border="1"> <thead> <tr> <th>Web</th> <th>Description</th> <th>UCI</th> </tr> </thead> <tbody> <tr> <td>Default: sha512</td> <td></td> <td>sha512</td> </tr> <tr> <td>sha384</td> <td></td> <td>sha284</td> </tr> <tr> <td>sha256</td> <td></td> <td>sha256</td> </tr> <tr> <td>sha1</td> <td></td> <td>sha1</td> </tr> <tr> <td>md5</td> <td></td> <td>md5</td> </tr> </tbody> </table>	Web	Description	UCI	Default: sha512		sha512	sha384		sha284	sha256		sha256	sha1		sha1	md5		md5
Web	Description	UCI																	
Default: sha512		sha512																	
sha384		sha284																	
sha256		sha256																	
sha1		sha1																	
md5		md5																	
Web: PKCS#7 Signature Algorithm UCI: strongswan.@scep_cert[0].pkcs10_sig_algo Opt: pkcs10_sig_algo	Defines the hash algorithm for pkcs10 signature. <table border="1"> <thead> <tr> <th>Web</th> <th>Description</th> <th>UCI</th> </tr> </thead> <tbody> <tr> <td>Default: sha512</td> <td></td> <td>sha512</td> </tr> <tr> <td>sha384</td> <td></td> <td>sha284</td> </tr> <tr> <td>sha256</td> <td></td> <td>sha256</td> </tr> <tr> <td>sha1</td> <td></td> <td>sha1</td> </tr> <tr> <td>md5</td> <td></td> <td>md5</td> </tr> </tbody> </table>	Web	Description	UCI	Default: sha512		sha512	sha384		sha284	sha256		sha256	sha1		sha1	md5		md5
Web	Description	UCI																	
Default: sha512		sha512																	
sha384		sha284																	
sha256		sha256																	
sha1		sha1																	
md5		md5																	
Web: CA Implementation UCI: strongswan.@scep_cert[0].caimpl Opt: caimpi	Defines the SCEP server implementation <table border="1"> <thead> <tr> <th>Web</th> <th>Description</th> <th>UCI</th> </tr> </thead> <tbody> <tr> <td>Default: Empty</td> <td>Automatically deducted from URL.</td> <td></td> </tr> <tr> <td>Microsoft CA</td> <td>Mircosoft CA</td> <td>ms</td> </tr> <tr> <td>EJB CA</td> <td>Enterprise Java Beans Certificate Authority</td> <td>ejbca</td> </tr> </tbody> </table>	Web	Description	UCI	Default: Empty	Automatically deducted from URL.		Microsoft CA	Mircosoft CA	ms	EJB CA	Enterprise Java Beans Certificate Authority	ejbca						
Web	Description	UCI																	
Default: Empty	Automatically deducted from URL.																		
Microsoft CA	Mircosoft CA	ms																	
EJB CA	Enterprise Java Beans Certificate Authority	ejbca																	

33.2. Configuring SCEP Certificate Using The Command Line

SCEP is configured using the `scep_cert` configuration section in the strongswan package

`/etc/config/strongswan.`

You can configure multiple SCEP configuration sections.

By default, all SCEP certificate instances are named 'scep_cert'. The SCEP certificate instance is identified by @scep_cert then the SCEP certificate position in the package as a number. For example, for the first SCEP certificate in the package using UCI, enter:

```
strongswan.@scep_cert[0]=scep_cert
strongswan.@scep_cert[0].enabled=1
```

Or using package options, enter:

```
config scep_cert
option enabled '1'
```

However, to better identify it, we recommend giving the SCEP certificate instance a name. For example, a SCEP certificate named 'SCEPCERT' will be strongswan.SCEPCERT.

To define a named SCEP certificate instance using UCI, enter:

```
strongswan.SCEPCERT=scep_cert
strongswan.SCEPCERT.enabled=1
```

To define a named SCEP certificate instance using package options, enter:

```
config scep_cert 'SCEPCERT'
option 'enabled' '1'
```

SCEP certificate using UCI

```
root@VA_router:~# uci show strongswan
package strongswan
#####
strongswan.SCEPCERT=scep_cert
strongswan.SCEPCERT.enabled=1
strongswan.SCEPCERT.url=url
strongswan.SCEPCERT.dn=dn
strongswan.SCEPCERT.scep_psk=password
strongswan.SCEPCERT.cert_path=/etc/ipsec.d/certs/
strongswan.SCEPCERT.key_path=/etc/ipsec.d/private/
strongswan.SCEPCERT.cacert=/etc/ipsec.d/cacerts/
strongswan.SCEPCERT.minmargin_hrs=10
strongswan.SCEPCERT.maxmargin_hrs=240
strongswan.SCEPCERT.minretry=10
strongswan.SCEPCERT.maxretry=100
strongswan.SCEPCERT.key_len=2048
strongswan.SCEPCERT.method=get
strongswan.SCEPCERT.pkcs7_enc_algo=aes256
strongswan.SCEPCERT.pkcs7_dgst_algo=sha512
strongswan.SCEPCERT.pkcs10_sig_algo=sha512
strongswan.SCEPCERT.caimpl=ms
```

SCEP certificate using package options

```
root@VA_router:~# uci export strongswan
package strongswan
#####
config scep_cert 'SCEPCERT'
option enabled '1'
option url 'url' option dn 'dn'
option scep_psk 'password'
option cert_path '/etc/ipsec.d/certs/'
option key_path '/etc/ipsec.d/private/'
option cacert '/etc/ipsec.d/cacerts/'
option minmargin_hrs '10'
option maxmargin_hrs '240'
option minretry '10'
option maxretry '100'
option key_len '2048' option method 'get'
option pkcs7_enc_algo 'aes256'
option pkcs7_dgst_algo 'sha512'
option pkcs10_sig_algo 'sha512'
option caimpl 'ms'
```

33.3. SCEP Diagnostics

Syslog

SCEP certificate status can be monitored via the system log. An example of SCEP syslog messages is shown below.

```
Aug 14 04:51:01 user:notice 00E0C81604BE ipsec: ca cert
'/etc/ipsec.d/cacerts/vaebjtest' expired or not yet downloaded

Aug 14 04:51:01 authpriv.info 00E0C81604BE scepclient[9146]: loaded plugins: curl aes des sha1 sha2 md5 random x509 pkcs1 pkcs7
pem openssl gmp

Aug 14 04:51:01 authpriv.info 00E0C81604BE scepclient[9146]: building CRED_CONTAINER - PKCS7 failed, tried 2 builders

Aug 14 04:51:01 authpriv.info 00E0C81604BE scepclient[9146]: unable to parse PKCS#7, assuming plain CA cert

Aug 14 04:51:01 authpriv.info 00E0C81604BE scepclient[9146]: written ca cert file '/etc/ipsec.d/cacerts/vaebjtest' (1200 bytes)

Aug 14 04:51:01 authpriv.info 00E0C81604BE ipsec_starter[9172]: Starting strongSwan 5.0.2 IPsec [starter]...

Aug 14 04:51:01 daemon.info 00E0C81604BE ipsec: 00[DMN] Starting IKE charon daemon (strongSwan 5.0.2, Linux 3.18.11, mips)

Aug 14 04:51:02 daemon.info 00E0C81604BE ipsec: 00[CFG] loading ca certificates from '/etc/ipsec.d/cacerts'

Aug 14 04:51:02 daemon.info 00E0C81604BE ipsec: 00[CFG] loaded ca certificate "CN=VAejbcaTestCA, O=VA, C=IE" from '/etc/
ipsec.d/cacerts/vaebjtest'

Aug 14 04:51:02 daemon.info 00E0C81604BE ipsec: 00[CFG] loading aa certificates from '/etc/ipsec.d/aacerts'

Aug 14 04:51:02 daemon.info 00E0C81604BE ipsec: 00[CFG] loading ocsp signer certificates from '/etc/ipsec.d/ocspcerts'

Aug 14 04:51:02 daemon.info 00E0C81604BE ipsec: 00[CFG] loading attribute certificates from '/etc/ipsec.d/acerts'

Aug 14 04:51:02 daemon.info 00E0C81604BE ipsec: 00[CFG] loading crls from '/etc/ipsec.d/crls'

Aug 14 04:51:02 daemon.info 00E0C81604BE ipsec: 00[CFG] loading secrets from '/etc/ipsec.secrets'

Aug 14 04:51:02 daemon.info 00E0C81604BE ipsec: 00[CFG] loading secrets from '/var/conf/ipsec.secrets'

Aug 14 04:51:02 daemon.info 00E0C81604BE ipsec: 00[CFG] loaded RSA private key from '/etc/ipsec.d/private/ejb_cert.pem'
```

33.4. Strongswan Process Using UCI

The strongswan process has its own subset of commands.

```
root@VA_router:~# /etc/init.d/strongswan
Syntax: /etc/init.d/dsl_control [command]
```

Available commands:

```
start Start the service
stop Stop the service
restart Restart the service
reload Reload configuration files (or restart if that fails)
enable Enable service autostart
disable Disable service autostart
```

To restart strongswan, enter:

```
root@VA_router:~# /etc/init.d/strongswan restart
```

34. Dynamic Multipoint Virtual Private Network (DMVPN)

Dynamic Multipoint Virtual Private Network (DMVPN) is a scalable method of creating VPN IPsec networks. DMVPN is a suite of three protocols: NHRP, GRE and IPsec, used to dynamically create VPN tunnels between different endpoints in the network without having to pre-configure each device with VPN details of the rest of endpoints in the network.

Prerequisites for Configuring DMVPN

Before configuring DMVPN, you must first configure:

- A GRE interface; read the previous chapter, 'Configuring GRE interfaces'.
- An IPsec connection to use as a template. Read the previous chapter 'Configuring IPsec'.

Advantages of using DMVPN

Using DMVPN eliminates the need of IPsec configuration to the physical interface. This reduces the number of lines of configuration required for a VPN development. For example, for a 1000-site deployment, DMVPN reduces the configuration effort at the hub from 3900 lines to 13.

- Adding new peers (spokes) to the VPN requires no changes at the hub.
- Better scalability of the network.
- Dynamic IP addresses can be used at the peer's site.
- Spokes can be connected in private or public network.
- NHRP NAT extension allows spoke-to-spoke tunnels to be built, even if one or more spokes is behind a Network Address Translation (NAT) device.
- New hubs can be added to the network to improve the performances and reliability.
- Ability to carry multicast and main routing protocols traffic (RIP, OSPF, BGP).
- DMVPN can be deployed using Activator, the automated provisioning system.
- Simplifies branch communications by enabling direct branch to branch connectivity.
- Simplifies configuration on the spoke routers. The same IPsec template configuration is used to create spoke-to-hub and spoke-to-spoke VPN IPsec tunnel.
- Improves business resiliency by preventing disruption of business-critical applications and services by incorporating routing with standards-based IPsec technology.

34.1. Configuring DMVPN Using The Web Interface

Configuration Packages Used

Package	Sections
network	For configuring GRE tunnels.
strongswan	For enabling and configuring the IPsec connection template
dmvpn	

The DMVPN section contains fields required to configure the parameters relative to the DMVPN Hub. These are used for DMVPN tunnels, such as GRE tunnels, GRE tunnel remote IP, DMVPN Hub IP and password.

There are two sections in the DMVPN page: General and DMVPN Hub Settings.

DMVPN General Settings

In the top menu, select **Network -> DMVPN**. The DMVPN page appears.

DMVPN

General Delete

Enable DMVPN

IPsec template connection:

The DMVPN general section

Web Field/UCI/Package Option	Description				
Web: Enable DMVPN UCI: dmvpn.common.enabled Opt: enable	Enables DMVPN. <table border="1"> <tr> <td>Default: 0</td> <td>Disabled</td> </tr> <tr> <td>1md5</td> <td>Enabled</td> </tr> </table>	Default: 0	Disabled	1md5	Enabled
Default: 0	Disabled				
1md5	Enabled				
Web: IPsec template connection UCI: dmvpn.common.ipsec_template_name Opt: ipsec_template_name	Selects the IPsec connection, defined in strongSwan, to be used as a template.				

DMVPN Hub Settings

DMVPN Hub Settings

GRE Interface	GRE Remote Endpoint IP Address	GRE Remote Endpoint Mask Length	DMVPN Hub IP Address	NHRP Authentication	NHRP Holding Time	Use as Default Route	Default Route Metric	LED state indication
<input type="text" value="gre1"/>	<input type="text" value="10.2.5.6"/>	<input type="text"/>	<input type="text" value="192.168.15.2"/>	<input type="text"/>	<input type="text" value="600"/>	<input checked="" type="checkbox"/>	<input type="text" value="1"/>	<input type="text" value="vpn1"/> Delete
<p>Add</p> <p style="text-align: right;">Save & Apply Save Reset</p>								

The DMVPN hub settings section

Web Field/UCI/Option	Description				
Web: GRE Interface UCI: dmvpn.@interface[X].gre_interface Opt: gre_interface	Specifies which GRE interface will be used with this DMVPN configuration.				
Web: GRE Remote Endpoint IP Address UCI: dmvpn.@interface[X].gre_endpoint_ip Opt: gre_endpoint_ip	Configures the GRE IP address of the hub.				
Web: GRE Remote Endpoint Mask Length UCI: dmvpn.@interface[X].gre_endpoint_mask_length Opt: gre_endpoint_mask_length	Configures the length of the mask of the GRE interface on the hub. For example, if the mask is 255.255.0.0 the length will be 16.				
Web: DMVPN Hub IP Address UCI: dmvpn.@interface[X].nhs_ip Opt: nhs_ip	Configures the physical IP address for the DMVPN hub.				
Web: NHRP Authentication UCI: dmvpn.@interface[X].cisco_auth Opt: cisco_auth	Enables authentication on NHRP. The password will be applied in plaintext to the outgoing NHRP packets. Maximum length is 8 characters.				
Web: NHRP Holding Time UCI: dmvpn.@interface[X].holding_time Opt: holding_time	Timeout for cached NHRP requests.				
Web: Use as Default Route UCI: dmvpn.@interface[X].defaultroute Opt: defaultroute	Adds a default route into tunnel interface. <table border="1" data-bbox="703 1144 1018 1216"> <tr> <td>incomplete</td> <td>Resolution request sent.</td> </tr> <tr> <td>1</td> <td>Negative cached.</td> </tr> </table>	incomplete	Resolution request sent.	1	Negative cached.
incomplete	Resolution request sent.				
1	Negative cached.				
Web: Default Route Metric UCI: dmvpn.@interface[X].defaultroutemetric Opt: defaultroutemetric	Metric to use for the default route.				
Web: LED state indication UCI: dmvpn.@interface[X].led Opt: led	LED to use for indicating if the VPN is up.				

34.2. DMVPN Scenarios

Scenario 1

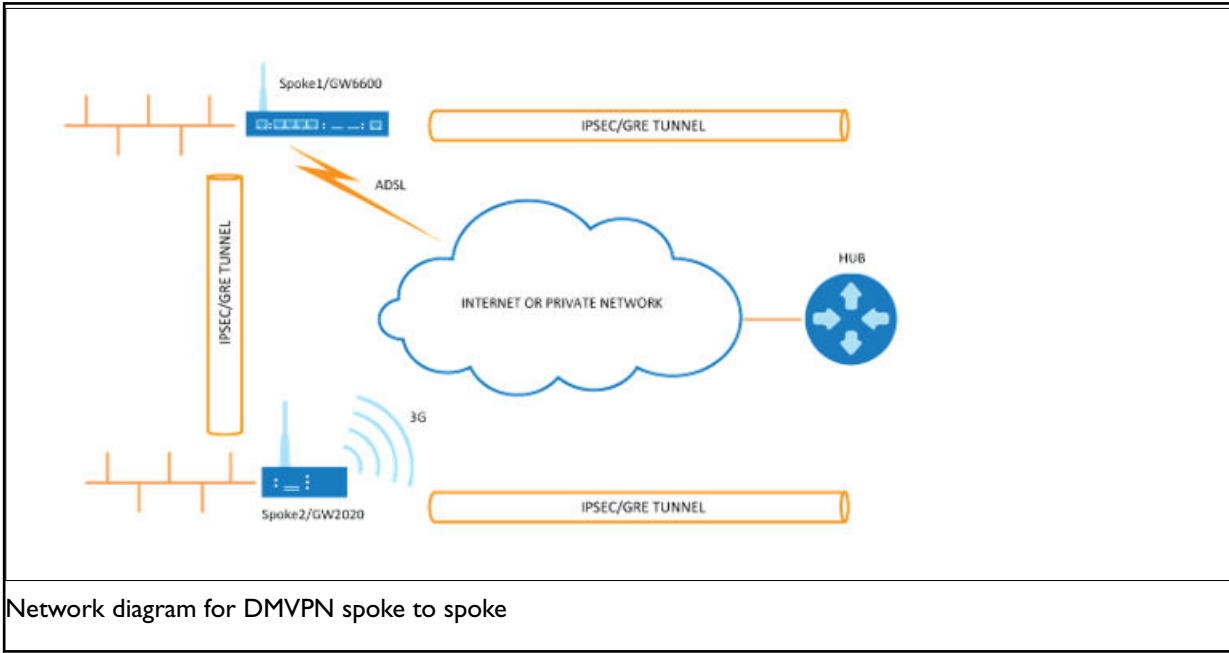

Spoke1, spoke2 and a hub are in the same public or private network.

- Spoke1 and spoke2 connect on their WAN interface: ADSL, 3G and initiate main mode IPsec in transport mode to the hub.
- After an IPsec tunnel is established, spokes register their NHRP membership with the hub.
- GRE tunnels come up.
- Hub caches the GRE tunnel and real IP addresses of each spoke.
- When spoke1 wants to talk to spoke2, it sends an NHRP resolution request to the hub.
- The hub checks its cache table and forwards that request to spoke2.
- Spoke2 caches spoke1's GRE and real IP address and sends an NHRP resolution reply via the hub.
- Spoke1 receives an NHRP resolution reply and updates its NHRP table with spoke2 information. Then it initiates VPN IPsec connection to spoke2.
- When an IPsec tunnel is established, spoke 1 and spoke 2 can send traffic directly to each other.

Scenario 2

Spoke1 is in a private (NAT-ed) network, spoke2 and hub are in public network.

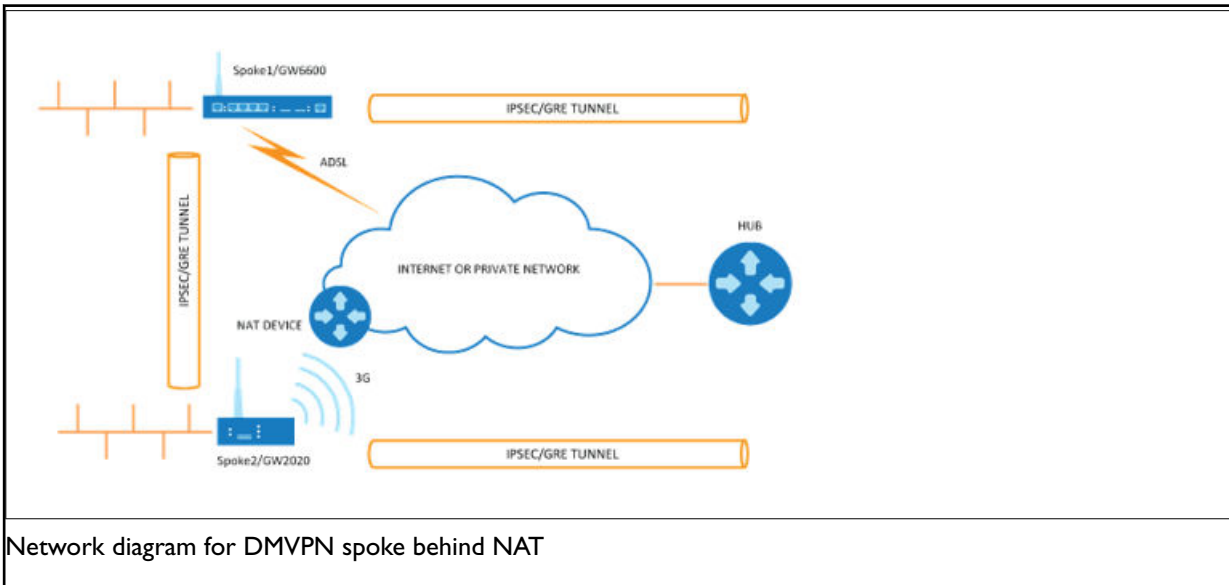

- Spoke1 sends an NHRP registration request to the hub.
- Hub receives this request and compares the source tunnel address of the spoke with the source of the packet.
- Hub sends an NHRP registration reply with a NAT extension to spoke1.
- The NAT extension informs spoke1 that it is behind the NAT-ed device.
- Spoke1 registers its pre- and post-NAT address.
- When spoke1 wants to talk to spoke2, it sends an NHRP resolution request to the hub.
- Hub checks its cache table and forwards that request to spoke2.
- Spoke2 caches spoke1's GRE pre- and post-NAT IP address and sends an NHRP resolution reply via the hub.
- Spoke1 receives the NHRP resolution reply and updates its NHRP table with spoke2 information. It initiates a VPN IPSec connection to spoke2.
- When the IPSec tunnel is established, spoke1 and spoke2 can send traffic directly to each other.



NOTE

If an IPSec tunnel fails to be established between the spokes then packets between the spokes are sent via the hub.

34.3. Configuring DMVPN Using The Web Interface

Configuration Packages Used

Package	Sections
network	For configuring GRE tunnels.
strongswan	For enabling and configuring the IPSec connection template
dmpvn	

The DMVPN section contains fields required to configure the parameters relative to the DMVPN Hub. These are used for DMVPN tunnels, such as GRE tunnels, GRE tunnel remote IP, DMVPN Hub IP and password.

There are two sections in the DMVPN page: General and DMVPN Hub Settings.

DMVPN General Settings

In the top menu, select **Network -> DMVPN**. The DMVPN page appears.

DMVPN

General Delete

Enable DMVPN

IPsec template connection

The DMVPN general section

Web Field/UCI/Package Option	Description				
Web: Enable DMVPN UCI: dmvpn.common.enabled Opt: enable	Enables DMVPN. <table border="1"> <tr> <td>Default: 0</td> <td>Disabled</td> </tr> <tr> <td>1md5</td> <td>Enabled</td> </tr> </table>	Default: 0	Disabled	1md5	Enabled
Default: 0	Disabled				
1md5	Enabled				
Web: IPsec template connection UCI: dmvpn.common.ipsec_template_name Opt: ipsec_template_name	Selects the IPsec connection, defined in strongSwan, to be used as a template.				

DMVPN Hub Settings

DMVPN Hub Settings

GRE Interface	GRE Remote Endpoint IP Address	GRE Remote Endpoint Mask Length	DMVPN Hub IP Address	NHRP Authentication	NHRP Holding Time	Use as Default Route	Default Route Metric	LED state indication
gre1	10.2.5.5		192.168.15.2		600	<input checked="" type="checkbox"/>	1	vgn1
<input type="button" value="Add"/> <input type="button" value="Save & Apply"/> <input type="button" value="Save"/> <input type="button" value="Reset"/>								

The DMVPN hub settings section

Web Field/UCI/Option	Description				
Web: GRE Interface UCI: dmvpn.@interface[X].gre_interface Opt: gre_interface	Specifies which GRE interface will be used with this DMVPN configuration.				
Web: GRE Remote Endpoint IP Address UCI: dmvpn.@interface[X].gre_endpoint_ip Opt: gre_endpoint_ip	Configures the GRE IP address of the hub.				
Web: GRE Remote Endpoint Mask Length UCI: dmvpn.@interface[X].gre_endpoint_mask_length Opt: gre_endpoint_mask_length	Configures the length of the mask of the GRE interface on the hub. For example, if the mask is 255.255.0.0 the length will be 16.				
Web: DMVPN Hub IP Address UCI: dmvpn.@interface[X].nhs_ip Opt: nhs_ip	Configures the physical IP address for the DMVPN hub.				
Web: NHRP Authentication UCI: dmvpn.@interface[X].cisco_auth Opt: cisco_auth	Enables authentication on NHRP. The password will be applied in plaintext to the outgoing NHRP packets. Maximum length is 8 characters.				
Web: NHRP Holding Time UCI: dmvpn.@interface[X].holding_time Opt: holding_time	Timeout for cached NHRP requests.				
Web: Use as Default Route UCI: dmvpn.@interface[X].defaultroute Opt: defaultroute	Adds a default route into tunnel interface. <table border="1" data-bbox="703 1144 1018 1216"> <tr> <td>incomplete</td> <td>Resolution request sent.</td> </tr> <tr> <td>1</td> <td>Negative cached.</td> </tr> </table>	incomplete	Resolution request sent.	1	Negative cached.
incomplete	Resolution request sent.				
1	Negative cached.				
Web: Default Route Metric UCI: dmvpn.@interface[X].defaultroutemetric Opt: defaultroutemetric	Metric to use for the default route.				
Web: LED state indication UCI: dmvpn.@interface[X].led Opt: led	LED to use for indicating if the VPN is up.				

34.4. DMVPN Diagnostics

In the top menu, click **Status -> IPSec**. The IPSec Connections page appears.

IPsec Connections									
Name	IKE					SA			
	Status	Remote	Established	Encryption	Integrity	Status	Policy	Data In/Out	Rekey in
dmvpn_213_233_148_2	ESTABLISHED	213.233.148.2	2 hours ago	3DES_CBC	HMAC_MD5_96	INSTALLED			
dmvpn_89_101_154_151	ESTABLISHED	89.101.154.151	2 hours ago	3DES_CBC	HMAC_MD5_96	INSTALLED			

The IPSec connections page

In the Name column, the syntax contains the IPsec name defined in package dmvpn and the remote IP address of the hub, or the spoke separated by an underscore; for example, dmvpn_213.233.148.2.

To check the status of DMVPN, in the top menu, click **Status -> DMVPN**.

NBMA peers			
NBMA Address	Interface	Address	Type
213.233.148.2	GRE	11.11.11.3/32	spoke
89.101.154.151	GRE	11.11.11.1/29	hub

Powered by LuCI Trunk (trunk+svn8382) VIE-16.00.28 image1 config2

The NBMA peers page

To check DMVPN status, enter:

```

:~# opennhrptl show
Status: ok
Interface: gre-GRE
Type: local
Protocol-Address: 11.11.11.7/32
Alias-Address: 11.11.11.3
Flags: up
Interface: gre-GRE
Type: local
Protocol-Address: 11.11.11.3/32
Flags: up
Interface: gre-GRE
Type: cached
Protocol-Address: 11.11.11.2/32
NBMA-Address: 178.237.115.129
NBMA-NAT-OA-Address: 172.20.38.129
Flags: used up
Expires-In: 0:18
Interface: gre-GRE
Type: static
Protocol-Address: 11.11.11.1/29
NBMA-Address: 89.101.154.151
Flags: up

```

Interface	Description	
Type	incomplete	Resolution request sent.
	negative	Negative cached.
	cached	Received/relayed resolution reply.
	shortcut_route	Received/relayed resolution for route.
	dynamic	NHC resolution.
	dynamic_nhs	Dynamic NHS from dns-map.
	static	Static mapping from config file.
	dynamic_map	Static dns-map from config file.
	local_route	Non-local destination, with local route.
	local_addr	Local destination (IP or off-NBMA subnet).
Protocol Address	Tunnel IP address	
NBMA-Address	Pre-NAT IP address if NBMA-NAT-OA-Address is present or real address if NAT is not present.	
NBMA-NAT-OA-Address	Post NAT IP address. This field is present when address is translated in the network.	
Flags	up	Can send all packets (registration ok).
	unique	Peer is unique.
	used	Peer is kernel ARP table.
	lower-up	openhyp script executed successfully.
Expires-In	Expiration time.	

You can check IPsec status using UCI commands.

```

root@VA-router:~# ipsec status
Security Associations (1 up, 0 connecting):
dmvpn_89_101_154_151[1]: ESTABLISHED 2 hours ago,
10.68.234.133[10.68.234.133]. 89.101.154.151[89.101.154.151]
dmvpn_89_101_154_151{1}: REKEYING, TRANSPORT, expires in 55 seconds
dmvpn_89_101_154_151{1}: 10.68.234.133/32[gre] === 192.168./32[gre]
dmvpn_89_101_154_151{1}: INSTALLED, TRANSPORT, ESP in UDP SPIs: cca7b970_id874dc90_o
dmvpn_89_101_154_151{1}: 10.68.234.133/32[gre] === 89.101.154.151/32[gre]

```

You can check DMVPN status using UCI commands.

```
:-# opennhrpctl show  
  
Status: ok  
  
Interface: gre-GRE  
  
Type: local  
  
Protocol-Address: 11.11.11.7/32  
  
Alias-Address: 11.11.11.3  
  
Flags: up  
  
Interface: gre-GRE  
  
Type: local  
  
Protocol-Address: 11.11.11.3/32  
  
Flags: up  
  
Interface: gre-GRE  
  
Type: cached  
  
Protocol-Address: 11.11.11.2/32  
  
NBMA-Address: 178.237.115.129  
  
NBMA-NAT-OA-Address: 172.20.38.129  
  
Flags: used up  
  
Expires-In: 0:18  
  
Interface: gre-GRE  
  
Type: static  
  
Protocol-Address: 11.11.11.1/29  
  
NBMA-Address: 89.101.154.151  
  
Flags: up
```

35. Configuring QoS: VLAN PCP Tagging

Merlin routers have the capability to respect and set PCP priority values inside 802.1Q VLAN tagged frames. The following partial export of network configuration shows how to configure VLAN priorities for specific interfaces (VLANs).

```
root@VA_router:~# uci export network package network
config va_switch
option eth0 'A E'
option eth1 'B F'
option eth2 'C G'
option eth3 'D'
option eth4 'H'
```

```

config interface 'VLAN_1'
option type 'bridge'
option proto 'static'
option ipaddr '10.1.28.99'
option netmask '255.255.0.0'
option ifname 'eth0 eth4'

config interface 'VLAN_2'
option type 'bridge'
option proto 'static'
option ipaddr '192.168.2.1'
option netmask '255.255.255.0'
option ifname 'eth1 eth4.2'
option vlan_qos_map_ingress '1:1'
option vlan_qos_map_egress '0:1'

config interface 'VLAN_3'
option ifname 'eth2 eth4.3'
option type 'bridge'
option proto 'static'
option ipaddr '192.168.3.1'
option netmask '255.255.255.0'
option vlan_qos_map_ingress '3:3'
option vlan_qos_map_egress '0:3'

config interface 'VLAN_4'
option ifname 'eth3 eth4.4'
option type 'bridge'
option proto 'static'
option ipaddr '192.168.3.1'
option netmask '255.255.255.0'
option vlan_qos_map_ingress '5:5'
option vlan_qos_map_egress '0:5'

```

UCI Package Options	Description
UCI: network.<if name>.vlan_qos_map_ingress Opt: list vlan_qos_map_ingress	VLAN priority code point to socket buffer mapping. Example: network.<if name>. vlan_qos_map_ingress =1:1
UCI: network.<if name>.vlan_qos_map_egress Opt: list vlan_qos_map_egress	Socket buffer to VLAN priority code point mapping. Example: network.<if name>. vlan_qos_map_egress =0:1

The above sample configuration specifies that any frames on VLAN2, VLAN3 and VLAN4 will be processed or have their PCP value adjusted according to QoS values set.

VLAN1 VLAN1 is an untagged VLAN so there are no 802.1Q tags on the frames.

VLAN2 Any frames received on VLAN2 destined to VLAN2 with PCP priority of 1 will be forwarded without altering the priority; it will be still set to 1. Any frames received on VLAN2 destined to VLAN2 with a PCP priority set to 0 will have a priority of 1 set as they leave the router on VLAN2.

VLAN3 Any frames received on VLAN3 destined to VLAN3 with a PCP priority of 3 will be forwarded without altering the priority; it will be still set to 3. Any frames received on VLAN3 destined to VLAN2 with PCP priority set to 0 will have a priority of 3 set as they leave the router on VLAN3.

VLAN4 Any frames received on VLAN4 destined to VLAN2 with PCP priority of 5 will be forwarded without altering the priority; it will be still set to 5. Any frames received on VLAN4 destined to VLAN2 with PCP priority set to 0 will have a priority of 5 set as they leave the router on VLAN4.

Four queues are supported and are structured as follows:

- Queue 1: PCP values 0 and 1 - Default
- Queue 2: PCP values 2 and 3 - Normal
- Queue 3: PCP values 4 and 5 - High
- Queue 4: PCP values 6 and 7 - Express

Value 7 is the highest priority and 0 is the lowest. These queues prioritise 802.1Q tagged frames as they are received on the port, these are hardware defined.

When 802.1Q frames are received on the port they are processed according to the above queues on arrival, even if not defined in the configuration. Then if value 'vlan_qos_map_ingress' is configured you can modify the PCP priority for egress if the frame was to be forwarded on another tagged interface.

When frames are received on an untagged VLAN interface configured with 'vlan_qos_map_egress' and are destined to tagged interface, 802.1Q tag will be created with a default priority of 0 and then the priority will be set according to the PCP value specified as the frames leave port.

36. Management Configuration Settings

This chapter contains the configuration sections and parameters required to manage and monitor your device using Activator and Monitor.

Activator

Activator is a proprietary provisioning system, where specific router configurations and firmware can be stored to allow central management and provisioning. Activator has two distinct roles in provisioning firmware and configuration files to a router.

- Autoload activation of firmware and configuration files on router boot up:
- Autoload is generally used for router installation. In this scenario the router will initiate the request for firmware and configuration files when it boots up. The router is installed with a factory config that will allow it to contact Activator. The autoload feature controls the behaviour of the router in requesting firmware and configuration files; this includes when to start the Activation process and the specific files requested. The HTTP Client (uhttpd) contains information about Activator server and the protocol used for activation.
- Deployment of firmware to routers after installation:
- In this scenario, Activator initiates the process. This process, known as Active Updates, allows for central automatic deployment of firmware and configuration files. It is used when configuration or firmware changes need to be pushed to live routers.

Monitor

Monitor is a proprietary tool, based on SNMP protocol, to monitor wide networks of deployed routers. The router is configured to send information to Monitor, which is then stored and viewed centrally via the Monitor application. This includes features such as traffic light availability status, syslog and SLA monitoring.

Configuration Packages Used

Package	Sections
autoload	main
httpclient	default
management_users	user

36.1. Autoload: Boot Up Activation

Autoload configurations specify how the device should behave with respect to activation when it boots up. Autoload entries contain information about the specific files to be downloaded and the destination for the downloaded file. Standard autoload entry configurations to download are:

- A firmware file (\$\$.img)
- A configuration file (\$\$.ini)
- A .vas file (\$\$.vas). This file signals the end of the autoloaod sequence to Activator

Activator identifies the device using the serial number of the router. \$\$ syntax is used to denote the serial number of the router when requesting a file. The requested files are written to the alternate image or config segment.

You can change the settings either directly in the configuration file or via appropriate UCI set commands. It is normal procedure for autoload to be enabled in the router's factory settings and disabled in running configurations (config 1 and 2).

Autoload may already have been set at factory config level. If you wish to enable autoload services, proceed through the following steps.

Autoload Packages

Package	Sections
autoload	main

Create a Configuration File

In the top menu, select **Services -> Autoload**. The Autoload page has two sections: Basic Settings and Entries. Click **Add** to access configuration settings for each section.

The screenshot shows the 'Autoload' configuration page. At the top, it says 'Configuration of the VA Autoload Service.' Below this is the 'Basic Settings' section with a note: 'Basic settings should be checked according to your network.' There is a 'Delete' button in the top right of this section. The settings include: 'Enabled' (checked checkbox), 'Start Timer' (input field with '10'), 'Retry Timer' (input field with '30'), 'Boot Using Config' (dropdown menu with 'altconfig'), and 'Boot Using Image' (dropdown menu with 'allimage'). Below this is the 'Entries' section, which contains a table with columns 'Configured', 'Segment Name', and 'Remote Filename'. There are three entries in the table, each with a 'Delete' button. Below the table is an 'Add' button. At the bottom right of the page are three buttons: 'Save & Apply', 'Save', and 'Reset'.

Autoload
Configuration of the VA Autoload Service.

Basic Settings
Basic settings should be checked according to your network.

Enabled

Start Timer

Retry Timer

Boot Using Config

Boot Using Image

Entries

Configured	Segment Name	Remote Filename
	<i>Download destination</i>	<i>Use \$\$ for the serial number.</i>
<input checked="" type="checkbox"/>	altconfig	\$\$.ini
<input checked="" type="checkbox"/>	allimage	\$\$.img
<input checked="" type="checkbox"/>	config1	\$\$.vas

Add

Save & Apply Save Reset

The autoload settings page

Web Field/UCI/Package Option	Description								
Basic Settings									
Web: Enabled UCI: autoload.main.enabled Opt: Enabled	Enables activation at system boot. <table border="1"> <tr> <td>Default: 0</td> <td>Disabled</td> </tr> <tr> <td>1</td> <td>Enabled</td> </tr> </table>	Default: 0	Disabled	1	Enabled				
Default: 0	Disabled								
1	Enabled								
Web: Start Timer UCI: autoload.main.StartTimer Opt: StartTimer	Defines how long to wait after the boot up completes before starting activation. <table border="1"> <tr> <td>Default: 10</td> <td></td> </tr> <tr> <td>Range</td> <td>0-300 secs</td> </tr> </table>	Default: 10		Range	0-300 secs				
Default: 10									
Range	0-300 secs								
Web: Retry Timer UCI: autoload.main.RetryTimer Opt: RetryTimer	Defines how many seconds to wait between retries if a download of a particular autoload entry fails. <table border="1"> <tr> <td>Default: 10</td> <td></td> </tr> <tr> <td>Range</td> <td>0-300 Secs</td> </tr> </table>	Default: 10		Range	0-300 Secs				
Default: 10									
Range	0-300 Secs								
Web: N/A UCI: autoload.main.NumberOfRetries Opt: Numberofretries	Defines how many retries to attempt before failing the overall activation sequence, backing off and trying the whole activation sequence again. <table border="1"> <tr> <td>Default: 5</td> <td></td> </tr> <tr> <td>Range</td> <td></td> </tr> </table>	Default: 5		Range					
Default: 5									
Range									
Web: N/A UCI: autoload.main.BackoffTimer Opt: Backofftimer	Defines how many minutes to back off for if a download and all retries fail. After the backoff period, the entire autoload sequence will start again. <table border="1"> <tr> <td>Default: 15</td> <td></td> </tr> <tr> <td>Range</td> <td></td> </tr> </table>	Default: 15		Range					
Default: 15									
Range									
Web: Boot Using Config UCI: autoload.main.BootUsingConfig Opt: BootUsingConfig	Specifies which configuration to boot up with after the activation sequence. <table border="1"> <tr> <td>Default: Altconfig</td> <td>Alternative configuration</td> </tr> <tr> <td>Config1</td> <td>Configuration 1</td> </tr> <tr> <td>Config2</td> <td>Configuration 2</td> </tr> <tr> <td>Factconf</td> <td>Factory configuration</td> </tr> </table>	Default: Altconfig	Alternative configuration	Config1	Configuration 1	Config2	Configuration 2	Factconf	Factory configuration
Default: Altconfig	Alternative configuration								
Config1	Configuration 1								
Config2	Configuration 2								
Factconf	Factory configuration								
Web: Boot Using Image UCI: autoload.main.BootUsingImage Opt: BootUsingImage	Specifies which image to boot up with after the activation sequence completes successfully. <table border="1"> <tr> <td>Default: Altimage</td> <td>Alternative image</td> </tr> <tr> <td>Image 1</td> <td>image 1</td> </tr> <tr> <td>Image 2</td> <td>image 2</td> </tr> </table>	Default: Altimage	Alternative image	Image 1	image 1	Image 2	image 2		
Default: Altimage	Alternative image								
Image 1	image 1								
Image 2	image 2								
Entries									
Web: Configured UCI: autoload.@entry[x].Configured Opt: Configured	Enables the autoload sequence to process this entry. <table border="1"> <tr> <td>Default: 0</td> <td>Disabled</td> </tr> <tr> <td>1</td> <td>Enabled</td> </tr> </table>	Default: 0	Disabled	1	Enabled				
Default: 0	Disabled								
1	Enabled								
Web: Segment Name UCI: autoload.@entry[x].SegmentName Opt: SegmentName	Defines where the downloaded file should be stored: (config1 config2 altconfig image1 image2 altimage). Typically only altconfig and altimage are used.								
Web: RemoteFilename UCI: autoload.@entry[x].RemoteFilename Opt: RemoteFilename	Defines the name of the file to be downloaded from Activator. <table border="1"> <tr> <td>\$\$\$.vas</td> <td>Notifies activator sequence is complete.</td> </tr> <tr> <td>\$\$\$.ini</td> <td>Request configuration</td> </tr> <tr> <td>\$\$\$.img</td> <td>Request firmware</td> </tr> </table> <p>Note: \$\$\$.vas should always be requested last.</p>	\$\$\$.vas	Notifies activator sequence is complete.	\$\$\$.ini	Request configuration	\$\$\$.img	Request firmware		
\$\$\$.vas	Notifies activator sequence is complete.								
\$\$\$.ini	Request configuration								
\$\$\$.img	Request firmware								

36.2. Autoload Using UCI

```
root@VA_router:/# uci show autoload
autoload.main=core
autoload.main.Enabled=yes
autoload.main.StartTimer=10
autoload.main.RetryTimer=30
autoload.main.NumberOfRetries=5
autoload.main.BackoffTimer=15
autoload.main.BootUsingConfig=altconfig
autoload.main.BootUsingImage=altimage
autoload.@entry[0]=entry
autoload.@entry[0].Configured=yes
autoload.@entry[0].SegmentName=altconfig
autoload.@entry[0].RemoteFilename=$.ini
autoload.@entry[1]=entry
autoload.@entry[1].Configured=yes
autoload.@entry[1].SegmentName=altimage
autoload.@entry[1].RemoteFilename=$.img
autoload.@entry[2]=entry
autoload.@entry[2].Configured=yes
autoload.@entry[2].SegmentName=config1
autoload.@entry[2].RemoteFilename=$.vas
```

Autoload using Package Options

```

root@VA_router:/# uci export autoload
package 'autoload'
config 'core' 'main'
option 'Enabled' "yes"
option 'StartTimer' "10"
option 'RetryTimer' "30"
option 'NumberOfRetries' "5"
option 'BackoffTimer' "15"
option 'BootUsingConfig' "altconfig"
option 'BootUsingImage' "altimage"
config 'entry'
option 'Configured' "yes"
option 'SegmentName' "altconfig"
option 'RemoteFilename' "\$\$.ini"
config 'entry'
option 'Configured' "yes"
option 'SegmentName' "altimage"
option 'RemoteFilename' "\$\$.img"
config 'entry'
option 'Configured' "yes"
option 'SegmentName' "config1"
option 'RemoteFilename' "\$\$.vas"

```

36.3. HTTP Client: Configuring Activation Using The Web Interface

This section contains the settings for the HTTP Client used during activation and active updates of the device.

The httpclient core section configures the basic functionality of the module used for retrieving files from Activator during the activation process.

HTTP Client Configuration Packages

Package	Sections
Httpclient	default

Web Configuration

To configure HTTP Client for Activator, in the top menu, click **Services -> HTTP Client**. The HTTP Client page has two sections: Basic Settings and Advanced Settings.

Http Client

Configuration of the Http Client used for management of the device. These settings are used to specify the interaction between this device and the Activator management system.

Basic Settings

Basic settings for the Activator client, check that these are correct according to your network.

Enabled

Server IP Address

Secure Server IP Address

Secure Download

Advanced Settings

Usually unnecessary to change these settings.

Activator Download Path

Check Server Certificate

Present Client Certificate to Server

Certificate File Format

Certificate File Path

Certificate Key File Path

The HTTP client page

Web Field/UCI/ Package Option	Description				
Basic Settings					
Web: Enabled UCI: httpclient.default.enabled Opt: Enabled	Enables the HTTP client. <table border="1"> <tr> <td>Default: 0</td> <td>Disabled</td> </tr> <tr> <td>1</td> <td>Enabled</td> </tr> </table>	Default: 0	Disabled	1	Enabled
Default: 0	Disabled				
1	Enabled				
Web: Server IP Address UCI: httpclient.default.Fileserver Opt: list Fileserver	Specifies the address of Activator that uses http port 80. This can be an IP address or FQDN. The syntax should be x.x.x.x:80 or FQDN:80. Multiple servers should be separated by a space using UCI.				
Web: Secure Server IP Address UCI: httpclient.default.SecureFileServer Opt: list SecureFileServer	Specifies the address of Secure Activator that uses port 443. This can be an IP address or FQDN. The syntax should be x.x.x.x:443 or FQDN:443. Multiple servers should be separated by a space using UCI.				
Web: Secure Download UCI: httpclient.default.SecureDownload Opt: SecureDownload	Enables Secure Download (port 443). <table border="1"> <tr> <td>Default: 0</td> <td>Disabled</td> </tr> <tr> <td>1</td> <td>Enabled</td> </tr> </table>	Default: 0	Disabled	1	Enabled
Default: 0	Disabled				
1	Enabled				
Advanced Settings					
Web: Activator Download Path UCI: httpclient.default.ActivatorDownloadPath Opt: ActivatorDownloadPath	Specifies the URL on Activator to which the client should send requests. <table border="1"> <tr> <td>Default:</td> <td>/Activator/Sessionless/Httpserver.asp</td> </tr> </table>	Default:	/Activator/Sessionless/Httpserver.asp		
Default:	/Activator/Sessionless/Httpserver.asp				
Web: Check Server Certificate UCI: httpclient.default.ValidateServerCertificateEnabled Opt: ValidateServerCertificateEnabled	Checks for the certificate's presence and validity. <table border="1"> <tr> <td>Default: 0</td> <td>Disabled</td> </tr> <tr> <td>1</td> <td>Enabled</td> </tr> </table>	Default: 0	Disabled	1	Enabled
Default: 0	Disabled				
1	Enabled				
Web: Present Client Certificate to Server UCI: httpclient.default.ValidateServerCertificateEnabled	Specifies if the client presents its certificate to the server to identify itself. <table border="1"> <tr> <td>Default: 0</td> <td>Disabled</td> </tr> <tr> <td>1</td> <td>Enabled</td> </tr> </table>	Default: 0	Disabled	1	Enabled
Default: 0	Disabled				
1	Enabled				

Web Field/UCI/ Package Option	Description				
Opt: ValidateServerCertificateEnabled					
Web: Certificate File Format UCI: httpclient.default.CertificateFormat Opt: CertificateFormat	Specifies the value the client expects to see in the specified field in the server certificate. <table border="1"> <tr> <td>Default:</td> <td>PEM</td> </tr> <tr> <td></td> <td>DER</td> </tr> </table>	Default:	PEM		DER
Default:	PEM				
	DER				
Web: Certificate File Path UCI: httpclient.default.CertificateFile Opt: CertificateFile	Defines the directory/location of the certificate. <table border="1"> <tr> <td>Default:</td> <td>/etc/httpclient.crt</td> </tr> </table>	Default:	/etc/httpclient.crt		
Default:	/etc/httpclient.crt				
Web: Certificate Key File Path UCI: httpclient.default.CertificateKey Opt: CertificateKey	Specifies the directory/location of the certificate key. <table border="1"> <tr> <td>Default:</td> <td>/etc/httpclient.key</td> </tr> </table>	Default:	/etc/httpclient.key		
Default:	/etc/httpclient.key				
Web: N/A UCI: httpclient.default.ActivatorChunkyDownloadPath Opt: ActivatorChunkyDownloadPath	Enables partial download activations and active updates. The default value is: <code>httpclient.default.ActivatorChunkyDownloadPath=/activator/partial/download</code> The URL, on Activator, to which the client should send requests for chunky image download.				
Web: N/A UCI: httpclient.default.ChunkSize Opt: ChunkSize	Specifies the size of each packet payload. <table border="1"> <tr> <td>Default:</td> <td>100k bytes</td> </tr> <tr> <td>1-infinite</td> <td>Available values in kbps</td> </tr> </table>	Default:	100k bytes	1-infinite	Available values in kbps
Default:	100k bytes				
1-infinite	Available values in kbps				
Web: N/A UCI: httpclient.default.RateLimit Opt: RateLimit	Throttle activation/active updates traffic received by device to specified limit. <table border="1"> <tr> <td>Default: None</td> <td>By default, there is no limit.</td> </tr> <tr> <td>1-infinite</td> <td>Available values in kbps</td> </tr> </table>	Default: None	By default, there is no limit.	1-infinite	Available values in kbps
Default: None	By default, there is no limit.				
1-infinite	Available values in kbps				
Web: N/A UCI: httpclient.default.CAFile Opt: CAFile	Defines the path to the certificate authority file stored on the router.				
Web: N/A UCI: httpclient.default.IgnoreServerCertificateStatus	Defines whether to skip the status check on the server certificate. <table border="1"> <tr> <td>Default: 0</td> <td>Disabled</td> </tr> <tr> <td>1</td> <td>Enabled</td> </tr> </table>	Default: 0	Disabled	1	Enabled
Default: 0	Disabled				
1	Enabled				

Web Field/UCI/ Package Option	Description
Opt: IgnoreServerCertificate Status	

36.4. Httpclient: Activator Configuration Using UCI

```

root@VA_router:~# uci show httpclient

httpclient.default=core
httpclient.default.Enabled=yes
httpclient.default.FileServer=10.1.83.36:80 10.1.83.37:80
httpclient.default.SecureFileServer=10.1.83.36:443 10.1.83.37:443
httpclient.default.ActivatorDownloadPath=/Activator/Sessionless/Httpserver.asp
httpclient.default.SecureDownload=no
httpclient.default.PresentCertificateEnabled=no
httpclient.default.ValidateServerCertificateEnabled=no
httpclient.default.CertificateFile=/etc/httpclient.crt
httpclient.default.CertificateFormat=PEM
httpclient.default.CertificateKey=/etc/httpclient.key
httpclient.default.ActivatorChunkyDownloadPath=/activator/partial/download
httpclient.default.ChunkSize=100k
httpclient.default.RateLimit=2
httpclient.default.CAFile='/'
httpclient.default.IgnoreServerCertificateStatus=0

```

Httpclient: Activator Configuration using Package Options

```

root@VA_router:~# uci export httpclient

package httpclient

config core 'default'

option Enabled 'yes'

list FileServer '1.1.1.1:80'

list FileServer '1.1.1.2:80'

listSecureFileServer '1.1.1.1:443'

list SecureFileServer '1.1.1.2:443'

option ActivatorDownloadPath '/Activator/Sessionless/Httpserver.asp'

option SecureDownload 'no'

option PresentCertificateEnabled 'no'

option ValidateServerCertificateEnabled 'no'

option CertificateFile '/etc/httpclient.crt'

option CertificateFormat 'PEM'

option CertificateKey '/etc/httpclient.key'

option ActivatorChunkyDownloadPath '/activator/partial/download'

option ChunkSize '100k'

option RateLimit '2'

option CAFile ''

option IgnoreServerCertificateStatus '0'

```

36.5. User Management Using UCI

User management is not currently available using the web interface. You can configure the feature using UCI or Activator.

Configuration packages used

Package	Sections
management_users	Users

Configuring User Management

You can create different users on the system by defining them in the user management configuration file. This gives users access to different services.

Web Field/UCI/Package Option	Description				
General settings					
Web: n/a UCI: management_users.@user[x].enabled Opt: enable	Enables/creates the user. <table border="1"> <tr> <td>Default: 0</td> <td>Disabled</td> </tr> <tr> <td>1</td> <td>Enabled</td> </tr> </table>	Default: 0	Disabled	1	Enabled
Default: 0	Disabled				
1	Enabled				
Web: n/a UCI: management_users.@user[x].username Opt: username	Specifies the user's username.				
Web: n/a UCI: management_users.@user[x].password Opt: password	Specifies the user's password. When entering the user password enter in plain text using the password option. After reboot the password is displayed encrypted via the CLI using the hashpassword option. UCI: <code>management_users.@user[x].hashpassword</code> Opt: hashpassword. Note: a SRP user password will be displayed using the srphash option.				
Web: n/a UCI: management_users.@user[x].webuser Opt: webuser	Specifies web access permissions for the user. Note: webuser will only work if linuxuser is set to Enabled . <table border="1"> <tr> <td>Default: 0</td> <td>Disabled</td> </tr> <tr> <td>1</td> <td>Enabled</td> </tr> </table>	Default: 0	Disabled	1	Enabled
Default: 0	Disabled				
1	Enabled				
Web: n/a UCI: management_users.@user[x].chapuser Opt: chapuser	Specifies CHAP access permissions for the PPP connection. Note: chapuser will only work if linux user is set to no . <table border="1"> <tr> <td>Default: 0</td> <td>Disabled</td> </tr> <tr> <td>1</td> <td>Enabled</td> </tr> </table>	Default: 0	Disabled	1	Enabled
Default: 0	Disabled				
1	Enabled				
Web: n/a UCI: management_users.@user[x].papuser Opt: papuser	Specifies PAP access permissions for the PPP connection. <table border="1"> <tr> <td>Default: 0</td> <td>Disabled</td> </tr> <tr> <td>1</td> <td>Enabled</td> </tr> </table>	Default: 0	Disabled	1	Enabled
Default: 0	Disabled				
1	Enabled				
Web: n/a UCI: management_users.@user[x].srpuser Opt: srpuser	Specifies SRP access permissions for the PPP connection. <table border="1"> <tr> <td>Default: 0</td> <td>Disabled</td> </tr> <tr> <td>1</td> <td>Enabled</td> </tr> </table>	Default: 0	Disabled	1	Enabled
Default: 0	Disabled				
1	Enabled				
Web: n/a UCI: management_users.@user[x].smsuser Opt: smsuser	Specifies SMS access permissions for the user. <table border="1"> <tr> <td>Default: 0</td> <td>Disabled</td> </tr> <tr> <td>1</td> <td>Enabled</td> </tr> </table>	Default: 0	Disabled	1	Enabled
Default: 0	Disabled				
1	Enabled				
Web: n/a UCI: linuxuser Opt: linuxuser	Specifies linuxuser access permissions for the user. <table border="1"> <tr> <td>Default: 0</td> <td>Disabled</td> </tr> <tr> <td>1</td> <td>Enabled</td> </tr> </table>	Default: 0	Disabled	1	Enabled
Default: 0	Disabled				
1	Enabled				
Web: n/a UCI: List allowed_pages Opt: list allowed_pages	Specifies which pages the user can view. Multiple pages should be entered using a space to separate if using UCI.				

Note:



NOTE

webuser will only work if linuxuser is set to **yes**

chapuser will only work if linuxuser is set to **no**

When a new user is created on the system and given web access, you will no longer be able to login to the router web interface with the default root user details. The user must use their new user login details.

User Management using UCI Example

```
root@VA_router:~# uci show management_users
management_users.@user[0]=user
management_users.@user[0].enabled=1
management_users.@user[0].username=test
management_users.@user[0].hashpassword=$1$XVzDHHPQ$SKK4geFonctihuffMjS4U0
management_users.@user[0].webuser=1
management_users.@user[0].linuxuser=1
management_users.@user[0].papuser=0
management_users.@user[0].chapuser=0
management_users.@user[0].srpuser=0
management_users.@user[0].smsuser=0
```

User Management using Package Options Example

```
root@VA_router:~# uci export management_users
package management_users
config user
option enabled '1'
option username 'test'
option hashpassword '$1$XVzDHHPQ$SKK4geFonctihuffMjS4U0'
option webuser '1'
option linuxuser '1'
option papuser '0'
option chapuser '0'
option srpuser '0'
option smsuser '0'
```

36.6. Configuring Management User Password Using UCI

The user password is displayed encrypted via the CLI using the hashpassword option.

```
root@VA_router:~# uci show management_users
management_users.@user[0].username=test
management_users.@user[0].hashpassword=$1$XVzDHHPQ$SKK4geFonctihuffMjS4U0
```

If you are changing the password via the UCI, enter the new password in plain text using the password option.

```
root@VA_router:~# uci set management_users.@user[0].password=newpassword
root@VA_router:~# uci commit
```

The new password will take effect after reboot and will now be displayed in encrypted format through the hashpassword option.

Using Package Options

The root password is displayed encrypted via CLI using the hashpassword option.

```
root@VA_router:~# uci export management_users
package management_users

config user

option hashpassword '$1$wRYYijOz$EeHN.GQcxXhRgNPVbqxVw'
```

If you are changing the password using UCI, enter the new password in plain text using the password option.

```
package management_users

config user

option hashpassword '$1$wRYYijOz$EeHN.GQcxXhRgNPVbqxVw'
option password 'newpassword'
```

The new password will take effect after reboot and will now be displayed in encrypted format via the hashpassword option.

36.7. Configuring User Access To Specific Web Pages

To specify particular pages a user can view, add the list allowed_pages. Examples are:

```
list allowed_pages '/admin/status'
```

The user can view admin status page only.

```
List allowed_pages '/admin/system/flashops'
```

The user can view flash operation page only. To specify monitor widgets only, enter:

```
listallowed_pages 'monitor/<widgetname>'
```

Example widget names are: dhcp, arp, 3gstats, interfaces, memory, multiwan, network, openvpn, routes, system, ipsec, dmvpn, tserverd.

37. Configuring Monitor

Introduction

Our monitoring system (Monitor) is a secure portal that provides:

- Central monitoring of devices
- Device status
- GPS location
- Syslog reporting
- Real time diagnostics
- Email notification
- Advanced statistics
- Dashboard graph reporting

You must configure each router in the network to send the required information to Monitor. This chapter explains how to configure the different information that can be sent to Monitor, including the required router configuration for:

- Reporting device status to Monitor
- Reporting GPS location to Monitor
- Reporting syslog to Monitor
- Interface statistic collection (ISAD)

37.1. Reporting Device Status To Monitor

To allow Monitor to track the IP address and ongoing presence of a device, a keepalive heartbeat SNMP trap is sent from the router. The router is capable of sending SNMP in version 1, 2c and 3.

The SNMP keepalive heartbeat sends basic information on interface status but can also be configured to contain more detailed information such as GPS location.

The basic heartbeat configuration consists of two parts:

- enabling the heartbeat keepalive
- enabling the interface(s) to be monitored

Configuration Package Used

Package	Sections
monitor	keepalive
network	interface

37.2. Configuring Keepalive Heartbeat Using The Web Interface

Select **Services** -> **Monitor**. The Monitor Keepalive & ISAD page appears. The keepalive heartbeat is configured under the **Basic Settings** section.

A single instance keepalive can be configured to multiple monitor address using the same reference, heartbeat interval and other options. Or alternatively multiple keepalive instances can be configured with unique options.

Monitor Keepalive & ISAD

Configuration of the VA Monitor Keepalive Service and Interface Stats Upload.

Basic Settings

Basic settings should be checked according to your network.

KEEPALIVE1

Enabled

Dev Reference

Monitor Address 

Monitor Heartbeat Interval

SNMP Protocol Version

The Monitor & ISAD keepalive page

Basic Settings

Web Field/UCI/Package Option	Description						
Web: Enabled UCI: monitor:@keepalive[0].enabled Opt: Enabled	Enables Monitor to send heartbeats to the router. <table border="1"> <tr> <td>Default: 0</td> <td>Disabled</td> </tr> <tr> <td>1</td> <td>Enabled</td> </tr> </table>	Default: 0	Disabled	1	Enabled		
Default: 0	Disabled						
1	Enabled						
Web: Dev Reference UCI: monitor:@keepalive[0].dev_reference Opt: dev_reference	Sets a unique identification for this device known to Monitor.						
Web: Monitor Address UCI: monitor:@keepalive[0].monitor_ip Opt: list monitor_ip	Defines the IP address of Monitor. It is possible to specify multiple addresses to which SNMP heartbeat traps will be sent. To configure via UCI use a space separator. Example: <code>monitor.@keepalive[0].monitor_ip=1.1.1.1 2.2.2.2</code>						
Web: Monitor Heartbeat Interval UCI: monitor:@keepalive[0].interval_min Opt: interval_min	Specifies the interval, in minutes, at which traps are sent. <table border="1"> <tr> <td>Default: 1</td> <td>SNMP version 1</td> </tr> <tr> <td>2c</td> <td>SNMP version 2c</td> </tr> <tr> <td>3</td> <td>SNMP version 3</td> </tr> </table>	Default: 1	SNMP version 1	2c	SNMP version 2c	3	SNMP version 3
Default: 1	SNMP version 1						
2c	SNMP version 2c						
3	SNMP version 3						

The figure below shows options that are relevant only if you have selected SNMP version 3.

SNMP Protocol Version	<input type="text" value="3"/>
User Name	<input type="text"/>
Authentication Protocol	<input type="text" value="SHA"/>
Authentication Password	<input type="text"/>
Privacy Protocol	<input type="text" value="AES"/>
Privacy Password	<input type="text"/>
SNMPv3 Context	<input type="text"/>
SNMPv3 Context Engine ID	<input type="text"/>
SNMPv3 Security Engine ID	<input type="text"/>

The Monitor & ISAD keepalive page for SNMP v3

Web Field/UCI/Package Option	Description						
Web: User Name UCI: monitor:@keepalive[0].snmp_uname Opt: snmp_uname	Specifies the user name. <table border="1"><tr><td>Default:</td><td>Blank</td></tr></table>	Default:	Blank				
Default:	Blank						
Web: Authentication Password UCI: monitor:@keepalive[0].snmp_auth_pass Opt: snmp_auth_pass	Specifies snmpv3 authentication password.						
Web: Authentication Protocol UCI: monitor:@keepalive[0].snmp_auth_proto Opt: snmp_auth_proto	Specifies snmpv3 authentication protocol. <table border="1"><tr><td>Default:</td><td>Blank</td></tr><tr><td>MD5</td><td>MD5 as authentication protocol.</td></tr><tr><td>SHA</td><td>SHA as authentication protocol.</td></tr></table>	Default:	Blank	MD5	MD5 as authentication protocol.	SHA	SHA as authentication protocol.
Default:	Blank						
MD5	MD5 as authentication protocol.						
SHA	SHA as authentication protocol.						
Web: Privacy Protocol UCI: monitor:@keepalive[0].snmp_priv_proto Opt: snmp_priv_proto	Specifies snmpv3 privacy protocol. <table border="1"><tr><td>Default:</td><td>Blank</td></tr><tr><td>AES</td><td>AED as privacy protocol.</td></tr><tr><td>DES</td><td>MD5 as privacy protocol.</td></tr></table>	Default:	Blank	AES	AED as privacy protocol.	DES	MD5 as privacy protocol.
Default:	Blank						
AES	AED as privacy protocol.						
DES	MD5 as privacy protocol.						
Web: Privacy Password UCI: monitor:@keepalive[0].snmp_priv_pass Opt: snmp_priv_pass	Specifies snmpv3 privacy password.						
Web: SNMPv3 Context UCI: monitor:@keepalive[0].snmp_context Opt: snmp_context	Specifies snmpv3 context name.						
Web: SNMPv3 Context Engine ID UCI: monitor:@keepalive[0].snmp_context_eid Opt: snmp_context_eid	Specifies snmpv3 context engine ID						

37.3. Configuring Keepalive Heartbeat Using Command Line

Keepalive is configured under the monitor package.

By default, all keepalive instances are named 'keepalive', instances are identified by @keepalive then the keepalive position in the package as a number. For example, for the first keepalive in the package using UCI:

```
monitor:@keepalive[0]=keepalive
monitor:@keepalive[0].enabled=1
```

Or using package options:

```
config keepalive
option enabled '1'
```

However, to better identify, it is recommended to give the keepalive instance a name. For example, to create a keepalive instance named keepalive1.

To define a named keepalive instance using UCI, enter:

```
monitor:keepalived1=keepalive
monitor:keepalived1.enable=1
```

To define a named keepalived instance using package options, enter:

```
config keepalived 'keepalived1'
option enabled '1'
```

Keepalived using UCI

```
root@VA_router:~# uci show monitor
monitor:keepalived1=keepalived
monitor:keepalived1.enabled=1
monitor:keepalived1.interval_min=1
monitor:keepalived1.dev_reference=router1
monitor:keepalived1.monitor_ip=10.1.83.36
monitor:keepalived1.snmp_version=1
monitor:keepalived2=keepalived
monitor:keepalived2.enable=1
monitor:keepalived2.interval_min=1
monitor:keepalived2.monitor_ip=172.16.250.100
monitor:keepalived2.dev_reference=TEST
monitor:keepalived2.snmp_version=2c
monitor:keepalived3=keepalived
monitor:keepalived3.enable=1
monitor:keepalived3.interval_min=1
monitor:keepalived3.monitor_ip=172.16.250.101
monitor:keepalived3.dev_reference=TEST
monitor:keepalived3.snmp_version=3
monitor:keepalived3.snmp_underscore=TEST
monitor:keepalived3.snmp_auth_pass=vasecret
monitor:keepalived3.snmp_auth_proto=MD5
monitor:keepalived3.snmp_priv_pass=vasecret
monitor:keepalived3.snmp_priv_proto=DES
```

Keepalived using Package Options

```
root@VA_router:~# uci export monitor
package 'monitor'

config keepalive 'keepalive1'
option enabled '1'
option interval_min '1'
option dev_reference 'router1'
option enabled 'yes'
list monitor_ip '10.1.83.36'

config keepalive 'keepalive2'
option enable '1'
option interval_min '1'
list monitor_ip '172.16.250.100'
option dev_reference 'TEST'
option snmp_version '2c'
config keepalive 'keepalive3'
option enable '1'
option interval_min '1'
list monitor_ip '172.16.250.101'
option dev_reference 'TEST'
option snmp_version '3'
option snmp_uname 'TEST'
option snmp_auth_pass 'vasecret'
option snmp_auth_proto 'MD5'
option snmp_priv_pass 'vasecret'
option snmp_priv_proto 'DES'
```

37.4. Enabling Interface Status In Keepalive Heartbeat Via Web Interface

The keepalive heartbeat can send information on multiple interfaces. To send an interface status to Monitor, select **Network -> Interfaces**, then under the required interface select **Edit**. Under **Advanced Settings** enable the Monitor interface state option.

Interfaces - WAN

On this page you can configure the network interfaces. You can bridge several interfaces by ticking the "bridge interfaces" field and spaces. You can also use VLAN notation `INTERFACE.VLANNR` (e.g., `eth0.1`).

Common Configuration

General Setup Advanced Settings Firewall Settings

Bring up on boot

Monitor interface state This interface state would be reported to VA Monitor via [keep-alive](#)

The interface common configuration page

Web Field/UCI/Package Option	Description				
Web: Monitor interface state	Enables interface status to be sent in the heartbeat trap to Monitor.				
UCI: network.@interface[0].monitored	<table border="1"> <tr> <td>Default: 0</td> <td>Disabled</td> </tr> <tr> <td>1</td> <td>Enabled</td> </tr> </table>	Default: 0	Disabled	1	Enabled
Default: 0	Disabled				
1	Enabled				
Opt: monitored					

37.5. Enable Interface Status Using UCI

Interface status is configured under the network package.

```
root@VA_router:~# uci show network
network.@interface[0]=interface
#####
network.@interface[0].monitored=1
#####
```

Enable Interface Status using Package Option

```
root@VA_router:~# uci export network
package network
config interface 'WAN'
#####
option monitored '1'
#####
```

37.6. Reporting GPS Location To Monitor

To allow Monitor to display a router GPS location, you can configure the GPS coordinates to be sent in the heartbeat keepalive from the router.

GPS location is only available in supported hardware models.

Ensure monitor heartbeat is correctly configured as in the previous section.

Package	Sections
gpsd	gpsd

Configuring GPS Location via the Web Interface

Select **Services -> GPS**. The GPS configuration page appears. The web interface configures a gpsd section named core.

Main Settings

Enable GPS

The GPS configuration page

Web Field/UCI/Package Option	Description
Web: Enable GPS	Enables GPS coordinates to be sent in the heartbeat keepalive to Monitor.
UCI: monitor.core.enabled	
Opt: enabled	

Default: 0	Disabled
1	Enabled

Configuring GPS Location using Command Line

GPS location is configured under the gpsd package.

GPS Location using UCI

```
root@VA_router:~# uci show gpsd
gpsd.core=gpsd
gpsd.core.enabled=1
```

GPS Location using Package Options

```
root@VA_router:~# uci export gpsd
package gpsd
config gpsd 'core'
option enabled '1'
```

37.7. GPS Diagnostics

To view information on GPS coordinates via the web interface, select **Status -> GPS Information**. There are two tabs: Status and Satellite Information.

GPS Status (Map)	
Enabled	Yes
Fix	Yes
Fix Mode	3D
Fix Time (UTC HH:MM:SS DD/Month/YYYY)	17:00:16 08/Dec/2021
Latitude	53.423493
Longitude	-7.984245
Altitude (m)	53
Speed (m/s)	0.00
Climb (m/s)	1.20

The GPS status page

Visible Satellites				
Used	PRN	Signal/Noise Ratio (dB)	Elevation	Azimuth
No	6	22	5	74
Yes	12	30	79	177
No	17	32	8	28
No	19	21	24	45
No	22	19	2	347
Yes	24	30	52	112
Yes	25	33	45	229
Yes	32	31	41	298
No	49	33	0	0

The GPS visible satellites page

To view GPS coordinates via command line, enter:

```
root@VA_router:~# gpspeek
Fix: 3D,1495467700,53.342529,-6.241236,27.700000,202.600000,0.000000,0.000000
```

37.8. Reporting Syslog To Monitor

Configuration Package Used

Package	Sections
system	main

Configuring Syslog to Monitor via the Web Interface

Monitor can display syslog events sent from the router. To configure the router to send syslog events, select **System -> System -> Logging** and set **External system log server** to the Monitor IP. You can also configure the syslog server port if required.

All syslog events are sent to the syslog server.

System

Here you can configure the basic aspects of your device like its hostname or the timezone.

System Properties

General Settings

Logging

Language and Style

System log buffer size	<input type="text" value="400"/>	kiB
External system log server	<input type="text" value="1.1.1.1"/>	
External system log server port	<input type="text" value="514"/>	

The system properties page

Web Field/UCI/Package Option	Description		
Web: External system log server UCI: system.main.log_ip Opt: log_ip	Defines the external syslog server IP address.		
Web: External system log server UCI: system.main.log_port Opt: log_port	Defines the external syslog server destination port number for syslog messages. <table border="1"><tr><td>Default:</td><td>514</td></tr></table>	Default:	514
Default:	514		

37.9. Configuring Syslog Events To Monitor Using Command Line

Syslog is configured under the system package.

Syslog Events to Monitor using UCI

```
root@VA_router:~# uci show system
system.main=system
system.main.log_ip=1.1.1.1
system.main.log_port=514
```

Syslog Events to Monitor using Package Options

```
root@VA_router:~# uci export system
package system
config system 'main'
option log_ip '1.1.1.1'
option log_port '514'
```

37.10. Configuring ISAD

ISAD is a system for collecting interface stats to be displayed on Monitor.

The following section explains how to configure interface statistics collection (iSAD). Statistical data is collected in bins with each bin containing interface transmit and receive packets/bytes/errors for a period. Signal strength and also temperature parameters are also stored in the bins. Bins are uploaded to Monitor periodically.



NOTE

ensure monitor keepalive heartbeat and interface status is correctly configured as in section 40.2 above. Interfaces should have option monitored enabled as part of the collection.

ISAD replaces the deprecated SLA feature.

Package	Sections
monitor	interface_stats

Configuring ISAD using the web interface

Interface Stats

Enabled

Bin Period

Maximum Number of Bins

The Monitor keepalive & ISAD interface stats page

Select **Services** -> **Monitor**. The Monitor Keepalive & ISAD page appears. ISAD is configured under the **Interface Stats** section.

Web Field/UCI/Package Option	Description				
Web: Enabled UCI: monitor.stats.enabled=1 Opt: enabled	Enables ISAD. <table border="1"> <tr> <td>Default: 0</td> <td>Disabled</td> </tr> <tr> <td>1</td> <td>Enabled</td> </tr> </table>	Default: 0	Disabled	1	Enabled
Default: 0	Disabled				
1	Enabled				
Web: Bin Period UCI: monitor.stats.bin_period Opt: time	Specifies how long to collect data for one bin. Specifies the interval, in minutes, at which traps are sent. <table border="1"> <tr> <td>Default: 1 hr</td> <td>Bin collected for 1 hour.</td> </tr> </table>	Default: 1 hr	Bin collected for 1 hour.		
Default: 1 hr	Bin collected for 1 hour.				
Web: Maximum Number of Bins UCI: monitor.stats.bin_cache_size Opt: bin_cache_size	Specifies the maximum number of bins to store. <table border="1"> <tr> <td>Default: Empty</td> <td>24</td> </tr> </table>	Default: Empty	24		
Default: Empty	24				

Configuring ISAD using the command line

ISAD is configured under the monitor package.

Configuring ISAD using UCI

```

root@VA_router:~# uci show monitor
monitor:keepalive1=keepalive
monitor:keepalive1.enabled=1
monitor:keepalive1.interval_min=1
monitor:keepalive1.dev_reference=router1
monitor:keepalive1.monitor_ip=10.1.83.36
monitor:keepalive1.snmp_version=1
monitor:stats=interface_stats
monitor:stats.enabled=1
monitor:stats.bin_period=1h
monitor:stats.bin_cache_size=24

```

Configuring ISAD using package options

```
root@VA_router:~# uci export monitor
package monitor

config keepalive 'keepalive1'
option interval_min '1'
option enabled '1'
list monitor_ip '10.1.83.36'
option dev_reference 'router1'

config interface_stats 'stats'
option enabled '1'
option bin_period '1h'
option bin_cache_size '24'
```

37.11. ISAD Diagnostics

Checking Process

To check to see if ISAD is running, enter:

```
root@VA_router:~# pgrep -fl isad
5303 /usr/sbin/isad -b 60 -s 10 -c 200 -u /var/state /var/const_state
```

Checking Bin Statistics

To check if stats are being collected, enter:

```
root@VA_router:~# cat /var/state/monitor
monitor.bin_0=isad
monitor.bin_0.end_ts=85020
monitor.bin_0.start_ts=84960
monitor.bin_1=isad
monitor.bin_1.end_ts=85080
monitor.bin_1.start_ts=85020
monitor.bin_2=isad
monitor.bin_2.end_ts=85140
monitor.bin_2.start_ts=85080
```

ISAD Operation

The bin statistics stored on the router must be periodically pushed statistics to Monitor. This is normally done centrally when statistics are enabled on Monitor. Monitor contacts each router and auto-generates a script that will automatically schedule the upload of the bin statistics.

However, if Monitor cannot access the router WAN IP, you must do this manually on each router using a UDS script. An example is shown below where the bins are uploaded every hour to a Monitor server IP 89.101.154.154 using TFTP.

```
package uds
config script 'isb_upload_scr'
option enabled '1'
option exec_type 'periodic'
option period '1h'
list text '/usr/sbin/isb_upload.lua 89.101.154.154:69'
```

37.12. Speedtest Reporting

To assist in determining WAN line speed characteristics the router can be configured to:

- Implement a Discard Protocol (RFC863)
- Implement a Character Generation Protocol (RFC864)

 **NOTE**
A central client is required to generate the speedtest traffic and produce the measurement reports.

Configuration is not currently available via the web interface.

Web Field/UCI/Package Option	Description				
Web: n/a UCI: monitor:speedtest.discard_enabled Opt: discard_enabled	Enables listening on TCP port 9 and discarding all received data. <table border="1"> <tr> <td>Default: 0</td> <td>Disabled</td> </tr> <tr> <td>1</td> <td>Enabled</td> </tr> </table>	Default: 0	Disabled	1	Enabled
Default: 0	Disabled				
1	Enabled				
Web: n/a UCI: monitor:speedtest.chargen_enabled Opt: chargen_enabled	Enables listening on TCP port 19 and streaming data to the connected client at maximum possible speed. <table border="1"> <tr> <td>Default: 0</td> <td>Disabled</td> </tr> <tr> <td>1</td> <td>Enabled</td> </tr> </table>	Default: 0	Disabled	1	Enabled
Default: 0	Disabled				
1	Enabled				

Configuring Speedtest via the Command Line

Speedtest options are configured in the speedtest configuration section of the monitor package.

Speedtest using UCI

```
root@VA_router:~# uci show monitor
monitor:speedtest=speedtest
monitor:speedtest.discard_enabled
monitor:speedtest.chargen_enabled
```

Speedtest using Package Options

```
root@VA_router:~# uci export monitor
package monitor

config speedtest
option discard_enabled '0'
option chargen_enabled '0'
```

38. Configuring SNMP

SNMP (Simple Network Management Protocol) is an internet-standard protocol for managing devices on IP networks. SNMP exposes management data in the form of a hierarchy of variables in a MIB (Management Information Base). These variables can be queried individually, or in groups using their OIDs (Objective Identifiers) defined in MIBs. In addition, information from the router can be pushed to a network management station in the form of SNMP traps.

Configuration Package Used

Package	Sections				
snmpd	access agent	exec	inventory	monitor_load	system trapreceiver
	com2sec	group heartbeat	inventory_iftable	monitor_memory	usm_user
	constant		monitor_disk	monitor_process	view
		informreceiver	monitor_ioerror	pass	

The SNMP application has several configuration sections:

System and Agent	Configures the SNMP agent
Com2Sec	Maps SNMP community names into an arbitrary security name.
Group	Assigns community names and SNMP protocols to groups.
View and Access	Creates views and sub-views of the whole available SNMP tree and grants specific access to those views on a group by group basis.
usm_user	Defines a user for SNMPv3 USM.
Trap Receiver	Sets the address of a notification receiver that should be sent SNMPv1 TRAPs and SNMPv2c TRAP2s.
Inform Receiver	Sets the address of a notification receiver that should be sent SNMPv2 INFORM notifications respectively.

38.1. Configuring SNMP Using The Web Interface

In the top menu, select **Services -> SNMP**. The SNMP Service page appears.

SNMP Service
Configuration of the SNMP service.

System Settings

System Location:

System Contact:

System Name:

Agent Settings

Agent Address:

Enable Authentication Traps:

Enable Link State Notification: Generate Trap/info when interface go up or down

The SNMP service page

System and Agent Settings

Web Field/UCI/Package Option	Description				
System Settings					
Web: System Location UCI: snmpd.system[0].sysLocation Opt: sysLocation	Sets the system location, system contact or system name for the agent. This information is reported in the 'system' group in the mibII tree.				
Web: System Contact UCI: snmpd.system[0].sysContact Opt: sysContact					
Web: System Name UCI: snmpd.system[0].sysName Opt: sysName					
Agent Settings					
Web: Agent Address UCI: snmpd.agent[0].agentaddress Opt: agentaddress	Specifies the address(es) and port(s) on which the agent should listen. [(udp tcp):][address:]port [,:##] Example: udp:127.0.0.1:161, tcp:161, localhost:9161				
Web: Enable Authentication Traps UCI: snmpd.agent[0].authtrappenabled Opt: authtrappenabled	Enables or disables SNMP authentication trap. <table border="1"> <tr> <td>Default: 0</td> <td>Disabled</td> </tr> <tr> <td>1</td> <td>Enabled</td> </tr> </table> <p>Note: this is the SNMP poll authentication trap you set when there is a community mismatch.</p>	Default: 0	Disabled	1	Enabled
Default: 0	Disabled				
1	Enabled				
Web: Enable Link State Notification UCI: snmpd.agent[0].link_updown_notify Opt: link_updown_notify	Generates trap/info when interface goes up or down. When enabled, the router sends a trap notification link up or down. <table border="1"> <tr> <td>Default: 0</td> <td>Disabled</td> </tr> <tr> <td>1</td> <td>Enabled</td> </tr> </table>	Default: 0	Disabled	1	Enabled
Default: 0	Disabled				
1	Enabled				

38.1.1. Com2Sec Settings

To access Com2Sec settings, scroll down the SNMP Services page.

Use the COM2Sec section to map SNMP community names into an arbitrary security name. Map community names into security names based on the community name and the source subnet. Use the first source/community combination that matches the incoming packet.

A community string is a password that is applied to a device to restrict both read-only and read-write access to the SNMP data on the device. These community strings should be chosen carefully to ensure they are not trivial. They should also be changed at regular intervals and in accordance with network security policies.

COM2SEC Settings

Security Name	Source	Community	
public <input type="text" value="ro"/>	<input type="text" value="default"/>	<input type="text" value="public"/>	<input type="button" value="Delete"/>
private <input type="text" value="rw"/>	<input type="text" value="localhost"/>	<input type="text" value="private"/>	<input type="button" value="Delete"/>
<input type="text"/>			<input type="button" value="Add"/>

The COM2SEC settings section

Web Field/UCI/Package Option	Description
Web: Security Name UCI: snmpd.com2sec[x].secname Opt: secname	Specifies an arbitrary security name for the user.
Web: Source UCI: snmpd.com2sec[x].source Opt: source	A hostname, localhost or a subnet specified as a.b.c.d/mask or a.b.c.d/bits or 'default' for no restrictions.
Web: Community UCI: snmpd.com2sec[x].community Opt: community	Specifies the community string being presented in the request.

38.1.2. Group Settings Using The Web Interface

Group settings assign community names and SNMP protocols to groups.

Group Settings

Group	Version	Security Name	
public_v1	public	v1	ro <input type="button" value="Delete"/>
public_v2c	public	v2c	ro <input type="button" value="Delete"/>
public_usm	public	usm	ro <input type="button" value="Delete"/>
private_v1	private	v1	rw <input type="button" value="Delete"/>
private_v2c	private	v2c	rw <input type="button" value="Delete"/>

The group settings section

Web Field/UCI/Package Option	Description								
Web: Group UCI: snmpd.group[x].group Opt: group	Specifies an arbitrary group name.								
Web: Version UCI: snmpd.group[x].version Opt: version	Specifies the SNMP version number being used in the request: v1, v2c and usm (User-based Security Module) are supported. <table border="1" style="margin-top: 10px; width: 100%;"> <tr> <td>Default: v1</td> <td>SNMP v1</td> </tr> <tr> <td>v2v</td> <td>SNMP v2</td> </tr> <tr> <td>usm</td> <td>SNMP v3</td> </tr> <tr> <td>any</td> <td>Any SNMP version</td> </tr> </table>	Default: v1	SNMP v1	v2v	SNMP v2	usm	SNMP v3	any	Any SNMP version
Default: v1	SNMP v1								
v2v	SNMP v2								
usm	SNMP v3								
any	Any SNMP version								
Web: Security Name UCI: snmpd.group[x].secname Opt: secname	Specifies the already defined security name that is being included in this group.								

38.1.3. View Settings

View settings define a named "view", which is a subset of the overall OID tree. This is most commonly a single subtree, but several view directives can be given with the same view name, to build up a more complex collection of OIDs.

View Settings

Name	Type	OID	
all	all	included	1
			Delete
			Add

The view settings section

Web Field/UCI/Package Option	Description				
Web: Name UCI: snmpd.view[x].viewname Opt: viewname	Specifies an arbitrary view name. Typically it describes what the view shows.				
Web: Type UCI: snmpd.view[x].type Opt: type	Specifies whether the view lists oids that are included in the view or lists oids to be excluded from the view; in which case all other oids are visible apart from those ones listed. <table border="1"> <tr> <td>Default:</td> <td>Included</td> </tr> <tr> <td></td> <td>Excluded</td> </tr> </table>	Default:	Included		Excluded
Default:	Included				
	Excluded				
Web: OID UCI: snmpd.view[x].oid Opt: oid	OID to be included in or excluded from the view. Only numerical representation is supported. <table border="1"> <tr> <td>Default: 1</td> <td>Everything</td> </tr> <tr> <td>1.3.6.1.2.1.2</td> <td>Interfaces table</td> </tr> </table>	Default: 1	Everything	1.3.6.1.2.1.2	Interfaces table
Default: 1	Everything				
1.3.6.1.2.1.2	Interfaces table				

38.1.4. Access Settings Using The Web Interface

Access settings map from a group of users/communities, in a specific context and with a particular SNMP version and minimum security level, to one of three views, depending on the request being processed.

Access Settings

	group	context	version	level	prefix	read	write	notify	
public_access	public	none	any	noauth	exact	all	none	none	Delete
private_access	private	none	any	noauth	exact	all	all	all	Delete
									Add

The access settings section

Web Field/UCI/Package Option	Description								
Web: Group UCI: snmpd.access[x].group Opt: group	Specifies the group to which access is being granted.								
Web: Context UCI: snmpd.access[x].context Opt: context	SNMPv3 request context is matched against the value according to the prefix below. For SNMP v1 and SNMP v2c, the context must be none . <table border="1" data-bbox="555 459 699 533"> <tr> <td>Default:</td> <td>none</td> </tr> <tr> <td></td> <td>all</td> </tr> </table>	Default:	none		all				
Default:	none								
	all								
Web: Version UCI: snmpd.access[x].version Opt: version	Specifies the SNMP version number being used in the request: any, v1, v2c and usm are supported. <table border="1" data-bbox="555 622 826 766"> <tr> <td>Default: v1</td> <td>SNMP v1</td> </tr> <tr> <td>v2v</td> <td>SNMP v2</td> </tr> <tr> <td>usm</td> <td>SNMP v3</td> </tr> <tr> <td>any</td> <td>Any SNMP version</td> </tr> </table>	Default: v1	SNMP v1	v2v	SNMP v2	usm	SNMP v3	any	Any SNMP version
Default: v1	SNMP v1								
v2v	SNMP v2								
usm	SNMP v3								
any	Any SNMP version								
Web: Level UCI: snmpd.access[x].level Opt: level	Specifies the security level. For SNMP v1 and SNMP v2c the level must be noauth . <table border="1" data-bbox="555 833 710 940"> <tr> <td>Default</td> <td>noauth</td> </tr> <tr> <td></td> <td>auth</td> </tr> <tr> <td></td> <td>priv</td> </tr> </table>	Default	noauth		auth		priv		
Default	noauth								
	auth								
	priv								
Web: Prefix UCI: snmpd.access[x].prefix Opt: prefix	Specifies how the context should be matched against the context of the incoming pdu. <table border="1" data-bbox="555 1003 699 1111"> <tr> <td>Default:</td> <td>exact</td> </tr> <tr> <td></td> <td>any</td> </tr> <tr> <td></td> <td>all</td> </tr> </table>	Default:	exact		any		all		
Default:	exact								
	any								
	all								
Web: Read UCI: snmpd.access[x].read Opt: read	Specifies the view to be used for read access.								
Web: Write UCI: snmpd.access[x].write Opt: write	Specifies the view to be used for write access.								
Web: Notify UCI: snmpd.access[x].notify Opt: notify	Specifies the view to be used for notify access.								

38.1.5. Trap Receiver

Trap receiver settings define a notification receiver that should be sent SNMPv1 TRAPs and SNMPv2c TRAP2.

Web Field/UCI/Package Option	Description				
Web: Host UCI: snmpd.trapreceiver[x].host Opt: host	Host address. Can be either an IP address or an FQDN.				
Web: Port UCI: snmpd.trapreceiver[x].port Opt: port	UDP port to be used for sending traps. <table border="1" data-bbox="571 432 703 468"> <tr> <td>Default:</td> <td>162</td> </tr> </table>	Default:	162		
Default:	162				
Web: Version UCI: snmpd.trapreceiver[x].version Opt: version	SNMP version. <table border="1" data-bbox="571 577 692 651"> <tr> <td>Default:</td> <td>v1</td> </tr> <tr> <td></td> <td>v2</td> </tr> </table>	Default:	v1		v2
Default:	v1				
	v2				
Web: Community UCI: snmpd.trapreceiver[x].community Opt: community	Community to use in trap messages for this host.				

38.1.6. Inform Receiver Using The Web Interface

Inform receiver settings define a notification receiver that should be sent SNMPv2c INFORM notifications.

Inform Receiver		
Host	Port	Community
<i>This section contains no values yet</i>		

The inform receiver settings page

Web Field/UCI/Package Option	Description
Web: Host UCI: snmpd.informreceiver[x].host Opt: host	Host address. Can be either an IP address or an FQDN.
Web: Port UCI: snmpd.informreceiver[x].port Opt: port	UDP port to be used for sending traps.
Web: Community UCI: snmpd.informreceiver[x].community Opt: community	Community to use in inform messages for this host.

38.1.7. USM User Using Web Interface

Configure a user for for SNMPv3 USM (User Based Security Model).

USM User					
Username	Auth Protocol	Auth Password	Priv Protocol	Priv Password	OID
<input type="text"/>	<input type="text"/>	<input type="text"/>	<input type="text"/>	<input type="text"/>	<input type="text"/>
	<input type="text"/>		<input type="text"/>		<input type="text"/>
	<input type="text"/>		<input type="text"/>		<input type="text"/>
					<input type="button" value="Delete"/>

The USM user settings page

Web Field/UCI/Package Option	Description				
Web: Username UCI: snmpd.@usm_user[0].name Opt: name	Defines a USM username.				
Web: Auth Protocol UCI: snmpd.@usm_user[0].auth_protocol Opt: auth_protocol	Defines the authentication protocol to use. Note: if omitted the user will be defined as noauth user. <table border="1"> <tr> <td>MD5</td> <td><input type="checkbox"/></td> </tr> <tr> <td>SHA</td> <td><input type="checkbox"/></td> </tr> </table>	MD5	<input type="checkbox"/>	SHA	<input type="checkbox"/>
MD5	<input type="checkbox"/>				
SHA	<input type="checkbox"/>				
Web: Auth Password UCI: snmpd.@usm_user[0].auth_password Opt: auth_password	Defines the authentication password. Note: password must be at least 8 characters long.				
Web: Priv Protocol UCI: snmpd.@usm_user[0].priv_protocol Opt: priv_protocol	Defines the privacy protocol to use. Note: if omitted the user will be defined as authNoPriv user. <table border="1"> <tr> <td>MD5</td> <td><input type="checkbox"/></td> </tr> <tr> <td>SHA</td> <td><input type="checkbox"/></td> </tr> </table>	MD5	<input type="checkbox"/>	SHA	<input type="checkbox"/>
MD5	<input type="checkbox"/>				
SHA	<input type="checkbox"/>				
Web: Priv Password UCI: snmpd.@usm_user[0].priv_password Opt: priv_password	Defines the privacy password. Note: the password must be at least 8 characters long.				
Web: OID UCI: snmpd.@usm_user[0].oid Opt: oid	Defines the OID branch to restrict this user to. Similar to view restrictions in v1 and v2c				

38.2. Configuring SNMP Using Command Line

SNMP is configured under the snmpd package. The configuration files are stored on `/etc/config/snmpd`.

System Settings using UCI

```

root@VA_router:~# uci show snmpd
snmpd.system=system
snmpd.system.sysLocation=Office 123
snmpd.system.sysContact=Mr White
snmpd.system.sysName=Backup Access 4
snmpd.agent=agent
snmpd.agent.agentaddress=UDP:161
snmpd.agent.authtrapenabled=yes
snmpd.agent.link_updown_notify=yes

```

System Settings using Package Options

```
root@VA_router:~# uci export snmpd
package snmpd config 'system'
option sysLocation 'Office 123'
option sysContact 'Mr White'
option sysName 'Backup Access 4'
config 'agent'
option agentaddress 'UDP:161'
option authtrapenabled '1'
option link_updown_notify '1'
```

Another sample agent configuration shown below causes the agent to listen on UDP port 161, TCP port 161 and UDP port 9161 on only the interface associated with the localhost address.

```
config 'agent'
option agentaddress 'UDP:161,tcp:161,localhost:9161'
```

38.2.1. Com2sec Using UCI

The following sample specifies that a request from any source using “public” as the community string will be dealt with using the security name “ro”. However, any request from the localhost itself using “private” as the community string will be dealt with using the security name “rw”.



NOTE

The security names of “ro” and “rw” here are simply names – the fact of a security name having read only or read-write permissions is handled in the access section and dealt with at a group granularity.

```
snmpd.c2s_1=com2sec
snmpd.c2s_1.source=default
snmpd.c2s_1.community=public
snmpd.c2s_1.secname=rw
snmpd.c2s_2=com2sec
snmpd.c2s_2.source=localhost
snmpd.c2s_2.community=private
snmpd.c2s_2.secname=ro
```

Com2sec using Package Options

```
config 'com2sec' 'public'  
option secname 'ro'  
option source 'default'  
option community 'public'  
config 'com2sec' 'private'  
option secname 'rw'  
option source 'localhost'  
option community 'private'
```

38.2.2. Group Settings Using Command Line

The following example specifies that a request from the security name “ro” using snmp v1, v2c or USM (User Based Security Model for SNMPv3) are all mapped to the “public” group. Similarly, requests from the security name “rw” in all protocols are mapped to the “private” group.

```
snmpd.grp_1_v1=group
snmpd.grp_1_v1.version=v1
snmpd.grp_1_v1.group=public
snmpd.grp_1_v1.secname=ro
snmpd.grp_1_v2c=group
snmpd.grp_1_v2c.version=v2c
snmpd.grp_1_v2c.group=public
snmpd.grp_1_v2c.secname=ro
snmpd.grp_1_usm=group
snmpd.grp_1_usm.version=usm
snmpd.grp_1_usm.group=public
snmpd.grp_1_usm.secname=ro
snmpd.grp_1_access=access
snmpd.grp_1_access.context=none
snmpd.grp_1_access.version=any
snmpd.grp_1_access.level=noauth
snmpd.grp_1_access.prefix=exact
snmpd.grp_1_access.read=all
snmpd.grp_1_access.write=none
snmpd.grp_1_access.notify=none
snmpd.grp_1_access.group=public
snmpd.grp_2_v1=group
snmpd.grp_2_v1.version=v1
snmpd.grp_2_v1.group=public
snmpd.grp_2_v1.secname=ro
snmpd.grp_2_v2c=group
snmpd.grp_2_v2c.version=v2c
snmpd.grp_2_v2c.group=public
snmpd.grp_2_v2c.secname=ro
snmpd.grp_2_usm=group
snmpd.grp_2_usm.version=usm
snmpd.grp_2_usm.group=public
snmpd.grp_2_usm.secname=ro
snmpd.grp_2_access=access
snmpd.grp_2_access.context=none
snmpd.grp_2_access.version=any
```

```
snmpd.grp_2_access.level=noauth
snmpd.grp_2_access.prefix=exact
snmpd.grp_2_access.read=all
snmpd.grp_2_access.write=all
snmpd.grp_2_access.notify=all
snmpd.grp_2_access.group=public
```

Group settings using package options

```
config 'group' 'public_v1'
option group 'public'
option version 'v1'
option secname 'ro'
config 'group' 'public_v2c'
option group 'public'
option version 'v2c'
option secname 'ro'
config 'group' 'public_usm'
option group 'public'
option version 'usm'
option secname 'ro'
config 'group' 'private_v1'
option group 'private'
option version 'v1'
option secname 'rw'
config 'group' 'private_v2c'
option group 'private'
option version 'v2c'
option secname 'rw'
config 'group' 'private_usm'
option group 'private'
option version 'usm'
option secname 'rw'
```

38.2.3. View Settings Using UCI

The following example defines two views, one for the entire system and another for only mib2.

```
snmpd.all=view
snmpd.all.viewname=all
snmpd.all.oid=.1
snmpd.mib2=view
snmpd.mib2.viewname=mib2
snmpd.mib2.type=included
snmpd.mib2.oid=.iso.org.dod.Internet.mgmt.mib-2
```

View Settings using Package Options

```
config 'view' 'all'
option viewname 'all'
option type 'included'
option oid '.1'
config 'view' 'mib2'
option viewname 'mib2'
option type 'included'
option oid '.iso.org.dod.Internet.mgmt.mib-2'
```

38.2.4. Access Settings Using Command Line

The following example shows the “public” group being granted read access on the “all” view and the “private” group being granted read and write access on the “all” view.

Although it is possible to write some settings using SNMP write permission, it is not recommended as any changes to the configuration made through an `snmpset` command may conflict with the UCI configuration. In this instance the changes will be overwritten by other processes and will not persist after a reboot.

Access using Package Options

```

config 'access' 'public_access'

option group 'public'

option context 'none'

option version 'any'

option level 'noauth'

option prefix 'exact'

option read 'all'

option write 'none'

option notify 'none'

config 'access' 'private_access'

option group 'private'

option context 'none'

option version 'any'

option level 'noauth'

option prefix 'exact'

option read 'all'

option write 'all'

option notify 'all'

```

38.2.5. SNMP Traps Settings Using Command Line

By default, all SNMP trap instances are named 'trapreceiver', it is identified by @trapreceiver then the trap receiver position in the package as a number. For example, for the first trap receiver in the package using UCI:

```

snmpd.@trapreceiver[0]=trapreceiver
snmpd.@trapreceiver[0].host=1.1.1.1:161

```

Or using package options:

```

config trapreceiver

```

```

option host '1.1.1.1:161'

```

However, to better identify it, it is recommended to give the trap receiver instance a name. For example, to create a trap receiver instance named TrapRecv1.

To define a named trap receiver instance using UCI, enter:

```

snmpd.TrapRecv1=TrapRecv1
snmpd.TrapRecv1.host=1.1.1.1:161

```

To define a named trap receiver instance using package options, enter:

```
config trapreceiver TrapRecv1
option host '1.1.1.1:161'
```

SNMP Trap using UCI

```
snmpd.@trapreceiver[0]=trapreceiver
snmpd.@trapreceiver[0].host=1.1.1.1:161
snmpd.@trapreceiver[0].version=v1
snmpd.@trapreceiver[0].community=public
```

SNMP Trap using Package Options

```
# for SNMPv1 or v2c trap receivers
config trapreceiver
option host 'IPADDR[:PORT]'
option version 'v1|v2c'
option community 'COMMUNITY STRING'
```

38.2.6. SNMP Inform Receiver Settings Using Command Line

By default, all SNMP inform receiver instances are named 'informreceiver', it is identified by @informreceiver then the inform receiver position in the package as a number. For example, for the first inform receiver in the package using UCI:

```
snmpd.@informreceiver [0]=informreceiver
snmpd.@informreceiver [0].host=1.1.1.1
```

Or using package options:

```
config informreceiver
option host '1.1.1.1'
```

However, to better identify it, it is recommended to give the inform receiver instance a name. For example, to create a inform receiver instance named InformRecv1.

To define a named trap receiver instance using UCI, enter:

```
snmpd.InformRecv1=InformRecv1
snmpd.InformRecv1.host=1.1.1.1
```

To define a named trap receiver instance using package options, enter:

```
config informreceiver InformRecv1
option host '1.1.1.1'
```

SNMP Inform Receiver using UCI

```
snmpd.@informreceiver[0]=informreceiver
snmpd.@informreceiver[0].host=1.1.1.1
snmpd.@informreceiver[0].port=67
snmpd.@informreceiver[0].community=private
```

SNMP Inform Receiver using Package Options

```
config informreceiver
option host '1.1.1.1'
option port '67'
option community 'private'
```

38.2.7. SNMP USM User Settings

By default, all USM User instances are named 'usm_user', it is identified by @usm_user then the USM user position in the package as a number. For example, for the first USM User in the package using UCI:

```
snmpd.@usm_user[0]=usm_user
snmpd.@usm_user[0].name=username
```

Or using package options:

```
config usm_user
option name 'username'
```

However, to better identify it, it is recommended to give the usm_user instance a name. For example, to create a usm_user instance named User1.

To define a named usm_user instance using UCI, enter:

```
snmpd.User1=User1
snmpd.User1.name=username
```

To define a named usm_user instance using package options, enter:

```
config usm_user 'User1'
option name 'username'
```

SNMP USM using UCI

```
snmpd.@usm_user[0]=usm_user
snmpd.@usm_user[0].name=username
snmpd.@usm_user[0].auth_protocol=SHA
snmpd.@usm_user[0].auth_password=password
snmpd.@usm_user[0].priv_protocol=AES
snmpd.@usm_user[0].priv_password=password
snmpd.@usm_user[0].oid=1.2.3.4
```

SNMP USM using Package Options

```
config usm_user
option name 'username'
option auth_protocol 'SHA'
option auth_password 'password'
option priv_protocol 'AES'
option priv_password 'aespassword'
option oid '1.2.3.4'
```

38.3. Configuring SNMP Interface Alias With Static SNMP Index

A Linux interface index changes dynamically. This is not ideal for SNMP managers that require static interface indexes to be defined.

The network package interface section allows defining a static SNMP interface alias index for this interface.

An alias entry is created in the SNMP ifEntry table at index (snmp_alias_ifindex + 1000). This entry is a shadow of the real underlying Linux interface corresponding to the UCI definition. You may use any numbering scheme you wish; the alias values do not need to be consecutive.

Package	Sections
network	interface

Configuring SNMP Interface Alias

To enter and SNMP alias for an interface, select **Network -> Interfaces -> Edit-> Common Configuration -> Advanced Settings**.

Enter a small index value for **SNMP Alias ifindex** that is unique to this interface. To retrieve SNMP statistics for this interface, configure the SNMP manager to poll (snmp_alias_ifindex + 1000). For example, if an interface is configured with an snmp_alias_ifindex of 11, then the SNMP manager should poll ifIndex=1011. The ifIndex will remain fixed regardless of how many times the underlying interface is added or removed.

If the Linux interface associated with the UCI entry is active when the alias index is polled, the normal ifEntry information for that interface is reported. Otherwise, a dummy entry is created with the same ifDescr, and its ifOper field set to **DOWN**.



NOTE

If you are using SIM roaming, where mobile interfaces are created dynamically, you need to specify a fixed snmp_alias_ifindex value and a fixed ifName value in the roaming template. All roaming entries will then map to the same Linux interface name and underlying device.

SNMP Alias ifindex Alias ifindex SNMP agent. Alias indexes are present at 1000 offset. So setting 1 here will create snmp ifTable entry 1001.
Useful when interface creates new linux interface on every startup (e.g. ppp interface). With this set the interface could be monitored via constant snmp agent interface table entry

The interface SNMP alias ifindex field advanced settings page

UCI/Package Option	Description				
Web: SNMP Alias ifindex UCI: network.@interface[X].snmp_alias_ifindex Opt: snmp_alias_ifindex	Defines a static SNMP interface alias index for this interface that can be polled using via the SNMP interface index. snmp_alias_ifindex+1000 <table border="1"> <tr> <td>Default: Blank</td> <td>No SNMP interface alias index</td> </tr> <tr> <td>Range:</td> <td>0-4294966295</td> </tr> </table>	Default: Blank	No SNMP interface alias index	Range:	0-4294966295
Default: Blank	No SNMP interface alias index				
Range:	0-4294966295				
Web: n/a UCI: network.@interface[X].snmp_alias_ifdescr Opt: snmp_alias_ifdescr	Defines an alias name to be reported for the UCI name in the enterprise MIB for UCI interfaces, and in alias entries in the ifIndex table. If present, this option supercedes the default ifDescr value (usually the UCI interface name, or configured ifName). <table border="1"> <tr> <td>Default: Blank</td> <td>No SNMP interface alias name</td> </tr> <tr> <td>Range:</td> <td></td> </tr> </table>	Default: Blank	No SNMP interface alias name	Range:	
Default: Blank	No SNMP interface alias name				
Range:					

38.4. Automatic SNMP Traps

Last Gasp

The router will automatically generate an SNMP trap when power loss is detected, and attempt to deliver to the configured trap receiver - ORK firmware family only.



NOTE

Whether the hardware is able to deliver the last gasp depends on the hold up time on the particular hardware model and the network conditions.

Event	SNMP Trap Format
Shutdown	{ SNMPv1 { Trap(28) E:8072.4 192.168.100.1 enterpriseSpecific s=2 8382 } }

Cold Start

On completion of system start up, the router will generate a cold start SNMP trap and deliver to the configured trap receiver.

Event	SNMP Trap Format
Startup	{ SNMPv1 { Trap(29) E:8072.3.2.10 192.168.100.1 coldStart 9 } }

38.5. SNMP Diagnostics

SNMP Process

To check the SNMP process is running correctly, enter:

```
root@VA_router:~# pgrep -fl snmpd
6970 /usr/sbin/snmpd -Lsd0-6 -p /var/run/snmpd.pid -m -c /var/conf/snmpd.conf
```

SNMP Port

To check the SNMP service is listening on the configured port, enter:

```
root@VA_router:~# netstat -pantu | grep snmp
udp    0 0 0.0.0.0:161    0.0.0.0:*      6970/snmpd
```

Reviving SNMP Values

SNMP values can be queried by an `snmpwalk` or `snmpget` command either locally or remotely.

snmpwalk

To create an `snmpwalk` locally, enter `snmpwalk`. An example `snmpwalk` is shown below:

```
root@VA_router:~# snmpwalk -c public -v 1localhost .1.3.6.1.2.1.1
iso.3.6.1.2.1.1.1.0= STRING: "Virtual Access GWXXXX, SN# 00E0C812D1A0,
EDG-21.00.07.008"
iso.3.6.1.2.1.1.2.0 = OID: iso.3.6.1.4.1.2078
iso.3.6.1.2.1.1.3.0 = Timeticks: (71816) 0:11:58.16
iso.3.6.1.2.1.1.4.0 = STRING: "info@virtualaccess.com"
iso.3.6.1.2.1.1.5.0 = STRING:"GWXXXX"
iso.3.6.1.2.1.1.6.0 = STRING: "UK"
iso.3.6.1.2.1.1.7.0 = INTEGER: 79
iso.3.6.1.2.1.1.8.0 = Timeticks: (60) 0:00:00.60
iso.3.6.1.2.1.1.9.1.2.1 = OID: iso.3.6.1.2.1.4
iso.3.6.1.2.1.1.9.1.2.2 = OID: iso.3.6.1.6.3.1
iso.3.6.1.2.1.1.9.1.2.3 = OID: iso.3.6.1.2.1.49
iso.3.6.1.2.1.1.9.1.2.4 = OID: iso.3.6.1.2.1.50
iso.3.6.1.2.1.1.9.1.2.5 = OID: iso.3.6.1.6.3.16.2.2.1
iso.3.6.1.2.1.1.9.1.2.6 = OID: iso.3.6.1.6.3.10.3.1.1
iso.3.6.1.2.1.1.9.1.2.7 = OID: iso.3.6.1.6.3.11.3.1.1
iso.3.6.1.2.1.1.9.1.2.8 = OID: iso.3.6.1.6.3.15.2.1.1
iso.3.6.1.2.1.1.9.1.2.9 = OID: iso.3.6.1.2.1.10.131
iso.3.6.1.2.1.1.9.1.4.4 = Timeticks: (35) 0:00:00.35
iso.3.6.1.2.1.1.9.1.4.5 = Timeticks: (38) 0:00:00.38
iso.3.6.1.2.1.1.9.1.4.6 = Timeticks: (38) 0:00:00.38
iso.3.6.1.2.1.1.9.1.4.7 = Timeticks: (38) 0:00:00.38
iso.3.6.1.2.1.1.9.1.4.8 = Timeticks: (38) 0:00:00.38
iso.3.6.1.2.1.1.9.1.4.9 = Timeticks: (60) 0:00:00.60
```

snmpget

To create an `snmpget` command locally, enter:

```
root@VA_router:~# snmpget -c public -v 1 localhost .1.3.6.1.4.1.2078.3.14.2
iso.3.6.1.4.1.2078.3.14.2 = STRING: "EDG-21.00.07.008"
```

SNMP Status

To see an overview including tx/rx packets and uptime of the SNMP process, enter:

```
root@VA_router:~# snmpstatus -c public -v 2c localhost
[UDP: [0.0.0.0]-&gt;[127.0.0.1]:161]=&gt;[Virtual Access GWXXXXX, SN#
00E0C812D1A0, EDG-21.00.07.008] Up: 0:17:05.87
```

39. Event System

Merlin routers feature an event system. It allows you to forward Merlin specific router events to predefined targets for efficient control and management of devices.

This chapter explains how the event system works and how to configure it using the web interface and the command line.

Configuration Package Used

Package	Section
va_eventd	main
	forwarding
	target
	conn_tester

39.1. Implementation Of The Event System

The event system is implemented by the `va_eventd` application. The `va_eventd` application defines three types of object.

Forwardings	Rules that define what kind of events should be generated. For example, you might want an event to be created when an IPSec tunnel comes up or down.
Targets	Define the targets to send the event to. The event may be sent to a target via a syslog message, an snmp trap or email.
Connection testers	Define methods to test the target is reachable. IP connectivity to a server and link state may be checked prior to sending events.

For example, if you want to configure an SNMP trap to be sent, when an IPSec tunnel comes up, you will need to:

- Define a forwarding rule for IPSec tunnel up events.
- Set an SNMP manager as the target.
- Optionally use a connection tester to ensure the SNMP manager is reachable.

Supported Events

Events have a class, ID name and a severity. These properties are used to fine tune which events to report.



NOTE

Only VA events can be forwarded using the event system. A comprehensive table of events is available from the CLI by entering `vae_cli -d`.

Supported Targets

The table below describes the targets currently supported.

Target	Description
Syslog	Event sent to syslog server.
Email	Event sent via email.
SNMP	Event sent via SNMP trap.
Exec	Command executed when event occurs.
SMS	Event sent via SMS.
File	Events written to a file.

The attributes of a target vary significantly depending on its type.

Supported Connection Testers

The table below describes the methods to test a connection that are currently supported.

Type	Description
link	Checks if the interface used to reach the target is up.
ping	Pings the target. And then assumes there is connectivity during a configurable amount of time.

39.2. Configuring The Event System Using The Web Interface

To configure the event system, select **Services -> VA Event System**. The VA Event System page appears.

There are four sections in the VA Event System page.

Section	Description
Basic Settings	Configures basic global event system parameters.
Connection Tester	Configures the connection testers.
Events Destination	Configures the event targets.
Event Filters	Configures the forwarding rules.

39.3. Connection Tester

A connection tester is used to verify the event destination before forwarding the event. Connection testers configure the uci `conn_tester` section rules. Multiple connection testers can be configured. There are two types of connection tester:

Type	Description
link	Checks if the interface used to reach the target is up.
ping	Pings the target. And then assumes there is connectivity during a configurable amount of time.

Connection Tester Delete

Enabled

Connection Tester Name:

Type:

Ping Target:

Ping Source:

Ping Success Duration: Every successful ping will allow uninterrupted event stream for the specified number of seconds

The event system connection tester configuration page

Web Field/UCI/Package Option	Description						
Web: Enabled UCI: va_eventd.@conn_tester[0].enabled Opt: enabled	Enables a connection tester. <table border="1"> <tr> <td>Default: 0</td> <td>Disabled</td> </tr> <tr> <td>1</td> <td>Enabled</td> </tr> </table>	Default: 0	Disabled	1	Enabled		
Default: 0	Disabled						
1	Enabled						
Web: Connection Tester Name UCI: va_eventd.@conn_tester[0].name Opt: name	Defines the connection tester name. This is used when configuring a connection tester for an event destination.						
Web: Type UCI: va_eventd.@conn_tester[0].type Opt: type	Defines the connection tester type. <table border="1"> <thead> <tr> <th>Web Value</th> <th>Description</th> <th>UCI</th> </tr> </thead> <tbody> <tr> <td>Ping</td> <td>Verifies target by ping</td> <td>ping</td> </tr> </tbody> </table>	Web Value	Description	UCI	Ping	Verifies target by ping	ping
Web Value	Description	UCI					
Ping	Verifies target by ping	ping					
Web: Ping Target UCI: va_eventd.@conn_tester[0].ping_dest_addr Opt: ping_dest_addr	Defines the IP address for the target ping. Note: only displayed if connection tester type is set to 'Ping'.						
Web: Ping Source UCI: va_eventd.@conn_tester[0].ping_source Opt: ping_source	Defines an interface or IP address to source the pings from.						
Web: Ping Success Duration UCI: va_eventd.@conn_tester[0].ping_success_duration_sec Opt: ping_success_duration_sec	Defines the duration, in seconds, for which a successful ping defines a connection tester as up. Note: only displayed if connection tester type is set to 'Ping'.						
Web: Link Interface UCI: va_eventd.@conn_tester[0].link_iface Opt: link_iface	Defines the interface to monitor when the connection tester type is set to 'link'. Configured interfaces are listed. Note: only displayed if configured syslog server.						

39.4. Event Destination

An event destination is the target for the event. Event destinations configure the uci target section rules. Multiple event destinations can be configured. There are currently six configurable event destinations.

Target Type	Description
Syslog	Event sent to syslog server.
Email	Event sent via email.
SNMP	Event sent via SNMP trap.
Execute	Command executed when event occurs.
SMS	Event sent via SMS.
File	Event written to a file

The available configuration options differ depending on the event destination type.

39.4.1. Syslog Target

When a syslog target receives an event, it sends it to the configured syslog server.

Event Destination Delete

Enabled

Destination Name

Type ▼

Connection Tester Name ▼

Destination Address

Syslog Over TCP

Message Template For Syslog and SNMP types message template has reasonable default so it is safe to leave blank

The event system syslog event destination configuration page

Web Field/UCI/Package Option	Description																					
Web: Enabled UCI: va_eventd.@target[0].enabled Opt: enabled	Enables an event destination. This is used in the event filters section. <table border="1"> <tr> <td>Default: 0</td> <td>Disabled</td> </tr> <tr> <td>1</td> <td>Enabled</td> </tr> </table>	Default: 0	Disabled	1	Enabled																	
Default: 0	Disabled																					
1	Enabled																					
Web: Destination name UCI: va_eventd.@target[0].name Opt: name	Defines a name for the event destination.																					
Web: Type UCI: va_eventd.@target[0].type Opt: type	Defines the event destination type. For syslog server choose Syslog . <table border="1"> <thead> <tr> <th>Web Value</th> <th>Description</th> <th>UCI</th> </tr> </thead> <tbody> <tr> <td>Syslog</td> <td>Syslog server</td> <td>syslog</td> </tr> <tr> <td>Email</td> <td>Event sent via email</td> <td></td> </tr> <tr> <td>SNMP</td> <td>Event sent via SNMP trap</td> <td></td> </tr> <tr> <td>Exec</td> <td>Command executed when event occurs</td> <td></td> </tr> <tr> <td>SMS</td> <td>Event send via SMS</td> <td></td> </tr> <tr> <td>File</td> <td>File targeter</td> <td></td> </tr> </tbody> </table>	Web Value	Description	UCI	Syslog	Syslog server	syslog	Email	Event sent via email		SNMP	Event sent via SNMP trap		Exec	Command executed when event occurs		SMS	Event send via SMS		File	File targeter	
Web Value	Description	UCI																				
Syslog	Syslog server	syslog																				
Email	Event sent via email																					
SNMP	Event sent via SNMP trap																					
Exec	Command executed when event occurs																					
SMS	Event send via SMS																					
File	File targeter																					
Web: Connection Tester Name UCI: va_eventd.@target[0]. conn_tester Opt: conn_tester	Defines the connection tester (if any) to use to verify the syslog target. <table border="1"> <tr> <td>Default: None</td> <td>No connection tester. UCI option not present.</td> </tr> <tr> <td>Range:</td> <td></td> </tr> </table>	Default: None	No connection tester. UCI option not present.	Range:																		
Default: None	No connection tester. UCI option not present.																					
Range:																						
Web: Destination Address UCI: va_eventd.@target[0]. target_addr Opt: target_addr	Defines the syslog target IP/FQDN and port. <table border="1"> <tr> <td>Default:</td> <td></td> </tr> <tr> <td>Range</td> <td>a.b.c.d : port or fqdn : port</td> </tr> </table>	Default:		Range	a.b.c.d : port or fqdn : port																	
Default:																						
Range	a.b.c.d : port or fqdn : port																					
Web: Syslog Over TCP UCI: va_eventd.@target[0].tcp_syslog Opt: tcp_syslog	Defines whether to use TCP for delivery of the syslog event. <table border="1"> <tr> <td>Default: 0</td> <td>Use UDP</td> </tr> <tr> <td>1</td> <td>Use TCP</td> </tr> </table>	Default: 0	Use UDP	1	Use TCP																	
Default: 0	Use UDP																					
1	Use TCP																					
Web: Message Template UCI: va_eventd.@target[0].template Opt: template	Defines the message template to use for the event. In general, this should be left empty. See the section on message templates below.																					
Web: n/a UCI: va_eventd.@target[0].facility Opt: facility	Defines a custom facility to overwrite existing facility on syslog messages before delivery to syslog target. <table border="1"> <tr> <td>Default:</td> <td>Does not overwrite existing facility.</td> </tr> <tr> <td>Range</td> <td></td> </tr> </table>	Default:	Does not overwrite existing facility.	Range																		
Default:	Does not overwrite existing facility.																					
Range																						
Web: n/a UCI: va_eventd.@target[0].severity Opt: severity	Defines a custom severity to overwrite existing severity on syslog messages before delivery to syslog target. <table border="1"> <tr> <td>Default:</td> <td>Does not overwrite existing facility.</td> </tr> <tr> <td>Range</td> <td></td> </tr> </table>	Default:	Does not overwrite existing facility.	Range																		
Default:	Does not overwrite existing facility.																					
Range																						

39.4.2. Email Target

When an email target receives an event, it sends it to the configured email address.

Event Destination Delete

Enabled

Destination Name

Type

Connection Tester Name

From

To

Subject Template Template for email subject

Body Template Template for email body. Safe to leave blank

SMTP Server Address

SMTP User Name

SMTP Password 

Use TLS

Send Timeout

The event system email event destination configuration page

Web Field/UCI/Package Option	Description																					
Web: Enabled UCI: va_eventd.@target[0].enabled Opt: enabled	Enables an event destination. <table border="1"> <tr> <td>Default: 0</td> <td>disabled</td> </tr> <tr> <td>1</td> <td>Enabled</td> </tr> </table>	Default: 0	disabled	1	Enabled																	
Default: 0	disabled																					
1	Enabled																					
Web: Destination name UCI: va_eventd.@target[0].name Opt: name	Defines a name for the event destination.																					
Web: Type UCI: va_eventd.@target[0].type Opt: type	Defines the event destination type. For an email server choose Email . <table border="1"> <thead> <tr> <th>Web Value</th> <th>Description</th> <th>UCI</th> </tr> </thead> <tbody> <tr> <td>Syslog</td> <td>Syslog target</td> <td>syslog</td> </tr> <tr> <td>SNMP Trap</td> <td>SNMP target</td> <td>snmptrap</td> </tr> <tr> <td>Email</td> <td>Email target</td> <td>email</td> </tr> <tr> <td>Execute</td> <td>Execute target</td> <td>exec</td> </tr> <tr> <td>SMS</td> <td>SMS target</td> <td>sms</td> </tr> <tr> <td>File</td> <td>File target</td> <td>file</td> </tr> </tbody> </table>	Web Value	Description	UCI	Syslog	Syslog target	syslog	SNMP Trap	SNMP target	snmptrap	Email	Email target	email	Execute	Execute target	exec	SMS	SMS target	sms	File	File target	file
Web Value	Description	UCI																				
Syslog	Syslog target	syslog																				
SNMP Trap	SNMP target	snmptrap																				
Email	Email target	email																				
Execute	Execute target	exec																				
SMS	SMS target	sms																				
File	File target	file																				
Web: Connection Tester Name UCI: va_eventd.@target[0]. conn_tester Opt: conn_tester	Defines the connection tester (if any) to use to verify the email target. <table border="1"> <tr> <td>Default:</td> <td>none. No connection tester. UCI option not present.</td> </tr> <tr> <td>Range</td> <td></td> </tr> </table>	Default:	none. No connection tester. UCI option not present.	Range																		
Default:	none. No connection tester. UCI option not present.																					
Range																						
Web: From UCI: va_eventd.@target[0].from Opt: from	Defines the 'from' address for the email.																					
Web: To UCI: va_eventd.@target[0].to Opt: to	Defines the 'to' address for the email.																					
Web: Subject Template UCI: va_eventd.@target[0].subject_template Opt: subject_template	Defines subject template for the email. In general, this should be left empty. Example: <code>va_eventd.@target[0].subject_template="%{severityName} % {eventName} !!! "</code> See the section on message templates below.																					
Web: Body Template UCI: va_eventd.@target[0].body_template Opt: body_template	Defines the email body template. In general, this should be left blank. Example: <code>va_eventd.@target[0].body_template="%{eventName} (%{class}:%{subclass}) happened!"</code> See the section on message templates below.																					
Web: SMTP Server Address UCI: va_eventd.@target[0].smtp_addr Opt: smtp.addr	Defines the email server address and port. <table border="1"> <tr> <td>Default:</td> <td></td> </tr> <tr> <td>Range</td> <td>a.b.c.d:port or fqdn:port</td> </tr> </table>	Default:		Range	a.b.c.d:port or fqdn:port																	
Default:																						
Range	a.b.c.d:port or fqdn:port																					
Web: SMTP User Name UCI: va_eventd.@target[0].smtp_user Opt: smtp_user	Defines user name for SMTP authentication.																					
Web: SMTP Password UCI: va_eventd.@target[0].smtp_password Opt: smtp_password	Defines the password for SMTP authentication.																					

Web Field/UCI/Package Option	Description				
Web: Use TLS UCI: va_eventd.@target[0].use_tls Opt: use_tls	Enables TLS (Transport Layer Security) support. <table border="1"> <tr> <td>Default:</td> <td>0</td> </tr> <tr> <td>Range</td> <td>0-1</td> </tr> </table>	Default:	0	Range	0-1
Default:	0				
Range	0-1				
Web: Send Timeout UCI: va_eventd.@target[0].timeout_sec Opt: timeout_sec	Defines the email send timeout in seconds. <table border="1"> <tr> <td>Default:</td> <td>10</td> </tr> <tr> <td>Range</td> <td></td> </tr> </table>	Default:	10	Range	
Default:	10				
Range					
Web: Use StartTLS UCI: va_eventd.@target[0].tls_starttls Opt: tls_starttls	Enables StartTLS support for TLS. (Only displayed when TLS is enabled) <table border="1"> <tr> <td>Default:</td> <td>0</td> </tr> <tr> <td>Range</td> <td>0-1</td> </tr> </table>	Default:	0	Range	0-1
Default:	0				
Range	0-1				
Web: Force SSLv3 UCI: va_eventd.@target[0].tls_forcessl3 Opt: tls_forcessl3	Enables force SSLv3 for TLS. (Only displayed when TLS is enabled)				

39.4.3. SNMP Target

When a SNMP target receives an event, it sends it in a trap to the configured SNMP manager.

Event Destination Delete

Enabled

Destination Name:

Type:

Connection Tester Name:

Destination Address:

Message Template: For Syslog and SNMP types message template has reasonable default so it is safe to leave blank

Agent Address:

SNMP Protocol Version:

Community:

The event system SNMP event destination configuration page

Web Field/UCI/Package Option	Description																					
Web: Enabled UCI: va_eventd.@target[0].enabled Opt: enabled	Enables an event destination. <table border="1"> <tr> <td>Default: 0</td> <td>Disabled</td> </tr> <tr> <td>1</td> <td>Enabled</td> </tr> </table>	Default: 0	Disabled	1	Enabled																	
Default: 0	Disabled																					
1	Enabled																					
Web: Destination name UCI: va_eventd.@target[0].name Opt: name	Defines a name for the event destination.																					
Web: Type UCI: va_eventd.@target[0].type Opt: type	Defines the event destination type. For SNMP server, choose SNMP Trap . <table border="1"> <thead> <tr> <th>Web Value</th> <th>Description</th> <th>UCI</th> </tr> </thead> <tbody> <tr> <td>Syslog</td> <td>Syslog target</td> <td>syslog</td> </tr> <tr> <td>SNMP Trap</td> <td>SNMP target</td> <td>snmptrap</td> </tr> <tr> <td>Email</td> <td>Email target</td> <td>email</td> </tr> <tr> <td>Execute</td> <td>Execute target</td> <td>exec</td> </tr> <tr> <td>SMS</td> <td>SMS target</td> <td>sms</td> </tr> <tr> <td>File</td> <td>File target</td> <td>file</td> </tr> </tbody> </table>	Web Value	Description	UCI	Syslog	Syslog target	syslog	SNMP Trap	SNMP target	snmptrap	Email	Email target	email	Execute	Execute target	exec	SMS	SMS target	sms	File	File target	file
Web Value	Description	UCI																				
Syslog	Syslog target	syslog																				
SNMP Trap	SNMP target	snmptrap																				
Email	Email target	email																				
Execute	Execute target	exec																				
SMS	SMS target	sms																				
File	File target	file																				
Web: Connection Tester Name UCI: va_eventd.@target[0]. conn_tester Opt: conn_tester	Defines the connection tester (if any) to use to verify the SNMP target. <table border="1"> <tr> <td>Default:</td> <td>None. No connection tester. UCI option not present.</td> </tr> </table>	Default:	None. No connection tester. UCI option not present.																			
Default:	None. No connection tester. UCI option not present.																					
Web: Destination Address UCI: va_eventd.@target[0]. target_addr Opt: target_addr	Defines the SNMP target IP/FQDN and port. <table border="1"> <tr> <td>Range:</td> <td>a.b.c.d:port or fqdn:port</td> </tr> </table>	Range:	a.b.c.d:port or fqdn:port																			
Range:	a.b.c.d:port or fqdn:port																					
Web: Message Template UCI: va_eventd.@target[0].template Opt: template	Defines the message template to use for the event. In general, this should be left empty. Example: <pre>va_eventd.@target[0].template="%{eventName} % {eventSpecificTemplate}"</pre> See the section on message templates below.																					
Web: Agent Address UCI: va_eventd.@target[0]. agent_addr Opt: agent_addr	Defines the IP address to source the SNMP trap. (optional) <table border="1"> <tr> <td>Default: localhost</td> <td>Local IP</td> </tr> <tr> <td>Range</td> <td>Localhost or IP address</td> </tr> </table>	Default: localhost	Local IP	Range	Localhost or IP address																	
Default: localhost	Local IP																					
Range	Localhost or IP address																					
Web: SNMP Protocol Version UCI: va_eventd.@target[0].snmp_version Opt: snmp_version	Defines the SNMP version. <table border="1"> <tr> <td>Default: 1</td> <td>SNMPv1</td> </tr> <tr> <td>2c</td> <td>SNMPv2c</td> </tr> <tr> <td>3</td> <td>SNMPv3</td> </tr> </table>	Default: 1	SNMPv1	2c	SNMPv2c	3	SNMPv3															
Default: 1	SNMPv1																					
2c	SNMPv2c																					
3	SNMPv3																					
Web: Community UCI: va_eventd.@target[0].community Opt: community	Defines the community string for SNMPv1.																					
Web: Username UCI: va_eventd.@target[0].snmp_undef Opt: snmp_undef	Defines the username for SNMPv3. Only displayed when SNMP protocol version is SNMPv3																					
Web: Authentication Protocol UCI: va_eventd.@target[0].snmp_auth_proto Opt: snmp_auth_proto	Defines the SNMPv3 authentication protocol. Only displayed when SNMP protocol version is SNMPv3.																					

<p>Web: Authentication Password</p> <p>UCI: va_eventd.@target[0].snmp_auth_pass</p> <p>Opt: snmp_auth_pass</p>	<p>Defines the SNMPv3 authentication password. Only displayed when SNMPv3 authentication protocol is configured.</p> <table border="1"> <tr><td>MD5</td><td></td></tr> <tr><td>SHA</td><td></td></tr> </table>	MD5		SHA	
MD5					
SHA					
<p>Web: Privacy Protocol</p> <p>UCI: va_eventd.@target[0].snmp_priv_proto</p> <p>Opt: snmp_priv_proto</p>	<p>Defines the SNMPv3 privacy protocol. Only displayed when SNMP authentication protocol is configured.</p> <table border="1"> <tr><td>MD5</td><td></td></tr> <tr><td>SHA</td><td></td></tr> </table>	MD5		SHA	
MD5					
SHA					
<p>Web: Privacy Password</p> <p>UCI: va_eventd.@target[0].snmp_priv_pass</p> <p>Opt: snmp_priv_pass</p>	<p>Defines SNMPv3 privacy password. Only displayed when SNMP privacy protocol is configured.</p> <table border="1"> <tr><td>DES</td><td></td></tr> <tr><td>AES</td><td></td></tr> </table>	DES		AES	
DES					
AES					
<p>Web: SNMPv3 Context</p> <p>UCI: va_eventd.@target[0].snmp_context</p> <p>Opt: snmp_context</p>	<p>Defines the SNMPv3 context. Only displayed when SNMP authentication protocol is configured.</p>				
<p>Web: SNMPv3 Context Engine ID</p> <p>UCI: va_eventd.@target[0].snmp_context_eid</p> <p>Opt: snmp_context_eid</p>	<p>Defines the SNMPv3 context engine ID. Only displayed when SNMP authentication protocol is configured.</p>				
<p>Web: SNMPv3 Security Engine ID</p> <p>UCI: va_eventd.@target[0].snmp_sec_eid</p> <p>Opt: snmp_sec_eid</p>	<p>Defines the SNMPv3 security engine ID. Only displayed when SNMP authentication protocol is configured.</p>				

39.4.4. Exec Target

When an Execute target receives an event, it executes a shell command.

Event Destination Delete

Enabled

Destination Name

Type

Connection Tester Name

Command Template Template for the command to be executed

The event system exec event destination configuration page

Web Field/UCI/Package Option	Description																					
Web: Enabled UCI: va_eventd.@target[0].enabled Opt: enabled	Enables an event destination. <table border="1"> <tr> <td>Default: 0</td> <td>Disabled</td> </tr> <tr> <td>1</td> <td>Enabled</td> </tr> </table>	Default: 0	Disabled	1	Enabled																	
Default: 0	Disabled																					
1	Enabled																					
Web: Destination name UCI: va_eventd.@target[0].name Opt: name	Defines a name for the event destination.																					
Web: Type UCI: va_eventd.@target[0].type Opt: type	Defines the event destination type. For shell command execution, choose Execute . <table border="1"> <thead> <tr> <th>Web Value</th> <th>Description</th> <th>UCI</th> </tr> </thead> <tbody> <tr> <td>Syslog</td> <td>Syslog target</td> <td>syslog</td> </tr> <tr> <td>SNMP Trap</td> <td>SNMP target</td> <td>snmptrap</td> </tr> <tr> <td>Email</td> <td>Email target</td> <td>email</td> </tr> <tr> <td>Execute</td> <td>Execute target</td> <td>exec</td> </tr> <tr> <td>SMS</td> <td>SMS target</td> <td>sms</td> </tr> <tr> <td>File</td> <td>File target</td> <td>file</td> </tr> </tbody> </table>	Web Value	Description	UCI	Syslog	Syslog target	syslog	SNMP Trap	SNMP target	snmptrap	Email	Email target	email	Execute	Execute target	exec	SMS	SMS target	sms	File	File target	file
Web Value	Description	UCI																				
Syslog	Syslog target	syslog																				
SNMP Trap	SNMP target	snmptrap																				
Email	Email target	email																				
Execute	Execute target	exec																				
SMS	SMS target	sms																				
File	File target	file																				
Web: Connection Tester Name UCI: va_eventd.@target[0]. conn_tester Opt: conn_tester	Defines the connection tester, if any, to use to verify the execute target. <table border="1"> <tr> <td>Default: None</td> <td>No connection tester. UCI option not present.</td> </tr> <tr> <td>Range</td> <td></td> </tr> </table>	Default: None	No connection tester. UCI option not present.	Range																		
Default: None	No connection tester. UCI option not present.																					
Range																						
Web: Command Template UCI: va_eventd.@target[0].cmd_template Opt: cmd_template	Defines the command template to use for the event. Example to log a syslog message: <code>va_eventd.@target[0].cmd_template="logger -t eventer % {eventName} "</code> See the section on message templates below.																					

39.4.5. SMS Target

When an SMS target receives an event, it sends an SMS message.

Event Destination Delete

Enabled

Destination Name

Type

Connection Tester Name

Message Template For Syslog and SNMP types message template has reasonable default so it is safe to leave blank

Phone Number Where text will be send

The event system SMS event destination configuration page

Web Field/UCI/Package Option	Description																					
Web: Enabled UCI: va_eventd.@target[0].enabled Opt: enabled	Enables an event destination. <table border="1"> <tr> <td>Default: 0</td> <td>Disabled</td> </tr> <tr> <td>1</td> <td>Enabled</td> </tr> </table>	Default: 0	Disabled	1	Enabled																	
Default: 0	Disabled																					
1	Enabled																					
Web: Destination name UCI: va_eventd.@target[0].name Opt: name	Defines a name for the event destination.																					
Web: Type UCI: va_eventd.@target[0].type Opt: type	Defines the event destination type. For SMS destination, choose SMS . <table border="1"> <thead> <tr> <th>Web Value</th> <th>Description</th> <th>UCI</th> </tr> </thead> <tbody> <tr> <td>Syslog</td> <td>Syslog target</td> <td>syslog</td> </tr> <tr> <td>SNMP Trap</td> <td>SNMP target</td> <td>snmptrap</td> </tr> <tr> <td>Email</td> <td>Email target</td> <td>email</td> </tr> <tr> <td>Execute</td> <td>Execute target</td> <td>exec</td> </tr> <tr> <td>SMS</td> <td>SMS target</td> <td>sms</td> </tr> <tr> <td>File</td> <td>File target</td> <td>file</td> </tr> </tbody> </table>	Web Value	Description	UCI	Syslog	Syslog target	syslog	SNMP Trap	SNMP target	snmptrap	Email	Email target	email	Execute	Execute target	exec	SMS	SMS target	sms	File	File target	file
Web Value	Description	UCI																				
Syslog	Syslog target	syslog																				
SNMP Trap	SNMP target	snmptrap																				
Email	Email target	email																				
Execute	Execute target	exec																				
SMS	SMS target	sms																				
File	File target	file																				
Web: Connection Tester Name UCI: va_eventd.@target[0].conn_tester Opt: conn_tester	Defines the connection tester, if any, to use to verify the SMS target. <table border="1"> <tr> <td>Default: None</td> <td>No connection tester. UCI option not present.</td> </tr> </table>	Default: None	No connection tester. UCI option not present.																			
Default: None	No connection tester. UCI option not present.																					
Web: Message Template UCI: va_eventd.@target[0].template Opt: template	Defines the message template to use for the event. In general, this should be left empty. Example: <code>va_eventd.@target[0].template="{eventName}"</code> See the section on message templates below.																					
Web: Phone Number UCI: va_eventd.@target[0].callee Opt: callee	Defines the phone number for sending SMS to.																					

39.4.6. File Target

When file target receives an event, it logs to a file.

Event Destination Delete

Enabled

Destination Name:

Type:

Connection Tester Name:

Message Template: For Syslog and SNMP types message template has reasonable default so it is safe to leave blank

File Name: File to store events

Max Size (KiB): Maximum file size in KiB. Older events will be overwritten when reached

The event system file event destination configuration page

Web Field/UCI/Package Option	Description																					
Web: Enabled UCI: va_eventd.@target[0].enabled Opt: enabled	Enables an event destination. <table border="1"> <tr> <td>Default: 0</td> <td>Disabled</td> </tr> <tr> <td>1</td> <td>Enabled</td> </tr> </table>	Default: 0	Disabled	1	Enabled																	
Default: 0	Disabled																					
1	Enabled																					
Web: Destination Name UCI: va_eventd.@target[0].name Opt: name	Defines a name for the event destination.																					
Web: Type UCI: va_eventd.@target[0].type Opt: type	Defines the event destination type. For file choose File . <table border="1"> <thead> <tr> <th>Web Value</th> <th>Description</th> <th>UCI</th> </tr> </thead> <tbody> <tr> <td>Syslog</td> <td>Syslog target</td> <td>syslog</td> </tr> <tr> <td>SNMP Trap</td> <td>SNMP target</td> <td>snmptrap</td> </tr> <tr> <td>Email</td> <td>Email target</td> <td>email</td> </tr> <tr> <td>Execute</td> <td>Execute target</td> <td>exec</td> </tr> <tr> <td>SMS</td> <td>SMS target</td> <td>sms</td> </tr> <tr> <td>File</td> <td>File target</td> <td>file</td> </tr> </tbody> </table>	Web Value	Description	UCI	Syslog	Syslog target	syslog	SNMP Trap	SNMP target	snmptrap	Email	Email target	email	Execute	Execute target	exec	SMS	SMS target	sms	File	File target	file
Web Value	Description	UCI																				
Syslog	Syslog target	syslog																				
SNMP Trap	SNMP target	snmptrap																				
Email	Email target	email																				
Execute	Execute target	exec																				
SMS	SMS target	sms																				
File	File target	file																				
Web: Connection Tester Name UCI: va_eventd.@target[0].conn_tester Opt: conn_tester	Defines the connection tester (if any) to use to verify the File target. <table border="1"> <tr> <td>Default: None</td> <td>No connection tester. UCI option not present</td> </tr> </table>	Default: None	No connection tester. UCI option not present																			
Default: None	No connection tester. UCI option not present																					
Web: Message Template UCI: va_eventd.@target[0].template Opt: template	Defines the message template to use for the event. In general, this should be left empty. See the section on message templates below.																					
Web: File Name UCI: va_eventd.@target[0].file_name Opt: file_name	Defines a file name for the event destination. Full path.																					
Web: Max Size (KiB) UCI: va_eventd.@target[0].max_size_kb Opt: file_name	Defines a file size in kilobits. <table border="1"> <tr> <td>Default:</td> <td>2048</td> </tr> </table>	Default:	2048																			
Default:	2048																					

39.5. Event Filters

Event filters are used to classify the events to be sent to the event destination. Multiple event filters can be defined. Event filters configure the uci forwarding section rules.

Event Filters Delete

Enabled

Class Name

Event Name

Minimum Severity

Maximum Severity

Target

The event system event filters configuration page

Web Field/UCI/Package Option	Description																
Web: Enabled UCI: va_eventd.@forwarding[0].enabled Opt: enabled	Enables an event filter. <table border="1"> <tr> <td>Default: 1</td> <td>Disabled</td> </tr> <tr> <td>0</td> <td>Enabled</td> </tr> </table>	Default: 1	Disabled	0	Enabled												
Default: 1	Disabled																
0	Enabled																
Web: Class Name UCI: va_eventd.@forwarding[0].className Opt: className	Only match events with the given class name. Available class names are listed or can be viewed using the command <code>vae_cli -d</code>																
Web: Event Name UCI: va_eventd.@forwarding[0].eventName Opt: eventName	Only match events with the given event name. Available event names are listed. The event name is optional and can be omitted.																
Web: Minimum Severity UCI: va_eventd.@forwarding[0].severity Opt: severity	Defines the minimum event severity. The minimum severity event is DEBUG. Events generated within the minimum and maximum event severity will be matched. Minimum and maximum severity are specified in the one UCI option and entered using a dash (-) separator in the form minimum-maximum. Example: <code>va_eventd.@forwarding[0].severity=debug-error</code> <table border="1"> <tr> <td>debug</td> <td>minimum severity</td> </tr> <tr> <td>info</td> <td></td> </tr> <tr> <td>notice</td> <td></td> </tr> <tr> <td>warning</td> <td></td> </tr> <tr> <td>error</td> <td></td> </tr> <tr> <td>critical</td> <td></td> </tr> <tr> <td>alert</td> <td></td> </tr> <tr> <td>emergency</td> <td>maximum severity</td> </tr> </table>	debug	minimum severity	info		notice		warning		error		critical		alert		emergency	maximum severity
debug	minimum severity																
info																	
notice																	
warning																	
error																	
critical																	
alert																	
emergency	maximum severity																
Web: Maximum Severity UCI: va_eventd.@forwarding[0].severity Opt: severity	Defines the maximum event severity. The maximum event severity is EMERGENCY. Events generated within the minimum and maximum event severity will be matched. The UCI command for specifying minimum and maximum severity is the same and is entered with two parameters using a dash (-) separator minimum-maximum. Example: <code>va_eventd.@forwarding[0].severity=debug-error</code> <table border="1"> <tr> <td>debug</td> <td>minimum severity</td> </tr> <tr> <td>info</td> <td></td> </tr> <tr> <td>notice</td> <td></td> </tr> <tr> <td>warning</td> <td></td> </tr> <tr> <td>error</td> <td></td> </tr> <tr> <td>critical</td> <td></td> </tr> <tr> <td>alert</td> <td></td> </tr> <tr> <td>emergency</td> <td>maximum severity</td> </tr> </table>	debug	minimum severity	info		notice		warning		error		critical		alert		emergency	maximum severity
debug	minimum severity																
info																	
notice																	
warning																	
error																	
critical																	
alert																	
emergency	maximum severity																
Web: Target UCI: va_eventd.@forwarding[0].target Opt: target	Defines the event destination to forward the event to. All configured event destinations will be displayed.																

39.6. Configuring The Event System Using Command Line

The event system configuration files are stored at `/etc/config/va_eventd`

There are four config sections main, conn_tester, target and forwarding. You can configure multiple conn_tester, target and forwarding sections.

By default, all conn_tester instances are named conn_tester, it is identified by @conn_tester then the conn_tester position in the package as a number. For example, for the first conn_tester in the package using UCI:

```
va_eventd.@conn_tester[0]=conn_tester
va_eventd.@conn_tester[0].enabled=1
```

Or using package options, enter:

```
config conn_tester
option enabled '1'
```

By default, all target instances are named target. The target instance is identified by @target then the target position in the package as a number. For example, for the first target in the package using UCI:

```
va_eventd.@target[0]=target
va_eventd.@target[0].enabled=1
```

Or using package options, enter:

```
config target
option enabled '1'
```

By default, all forwarding instances are named forwarding. The forwarding instance is identified by @forwarding then the forwarding position in the package as a number. For example, for the first forwarding rule in the package using UCI:

```
va_eventd.@forwarding[0]=forwarding
va_eventd.@forwarding[0].enabled=1
```

Or using package options:

```
config forwarding
option enabled '1'
```

39.6.1. Event System Using UCI

```
root@VA_router:~# uci show va_eventd

#Sample basic settings

va_eventd.main=va_eventd

va_eventd.main.event_queue_file=/tmp/event_buffer

va_eventd.main.event_queue_size=128K

#Sample SNMP

va_eventd.@conn_tester[0]=conn_tester

va_eventd.@conn_tester[0].type=ping

va_eventd.@conn_tester[0].ping_dest_addr=192.168.100.1

va_eventd.@conn_tester[0].ping_success_duration_sec=60

va_eventd.@conn_tester[0].name=SNMPTest

va_eventd.@conn_tester[0].ping_source=LAN1

va_eventd.@target[0]=target

va_eventd.@target[0].suppress_duplicate_forwardings=no

va_eventd.@target[0].type=snmp

va_eventd.@target[0].agent_addr=localhost

va_eventd.@target[0].name=SNMPTarget

va_eventd.@target[0].conn_tester=SNMPTest

va_eventd.@target[0].target_addr=192.168.100.126:68

va_eventd.@target[0].snmp_version=3

va_eventd.@target[0].snmp_uname=v3username

va_eventd.@target[0].snmp_auth_proto=MD5

va_eventd.@target[0].snmp_auth_pass=md5password

va_eventd.@target[0].snmp_priv_proto=AES

va_eventd.@target[0].snmp_priv_pass=aespassword

va_eventd.@target[0].snmp_context=v3context
```

```
va_eventd.@target[0].snmp_context_eid=v3contextID
va_eventd.@target[0].snmp_sec_eid=v3SecurityID
va_eventd.@forwarding[0]=forwarding
va_eventd.@forwarding[0].enabled=yes
va_eventd.@forwarding[0].className=mobile
va_eventd.@forwarding[0].target=SNMPTarget
va_eventd.@forwarding[0].eventName=LinkUp
va_eventd.@forwarding[0].severity=notice-notice

#Sample Syslog
va_eventd.@conn_tester[1]=conn_tester
va_eventd.@conn_tester[1].name=SyslogTest
va_eventd.@conn_tester[1].type=ping
va_eventd.@conn_tester[1].ping_dest_addr=192.168.100.2
va_eventd.@conn_tester[1].ping_source=LAN1
va_eventd.@conn_tester[1].ping_success_duration_sec=60
va_eventd.@target[1]=target
va_eventd.@target[1].name=SyslogTarget
va_eventd.@target[1].type=syslog
va_eventd.@target[1].conn_tester=SyslogTest
va_eventd.@target[1].target_addr=192.168.100.2:514
va_eventd.@target[1].tcp_syslog=0
va_eventd.@forwarding[1]=forwarding
va_eventd.@forwarding[1].enabled=yes
va_eventd.@forwarding[1].severity=debug-error
va_eventd.@forwarding[1].target=SyslogTarget

#Sample Email
va_eventd.@conn_tester[2]=conn_tester
va_eventd.@conn_tester[2].name=EmailTest
va_eventd.@conn_tester[2].type=link
va_eventd.@conn_tester[2].link_iface=PoAADSL
va_eventd.@target[2]=target
va_eventd.@target[2].timeout_sec=10
va_eventd.@target[2].name=EmailTarget
va_eventd.@target[2].type=email
va_eventd.@target[2].conn_tester=EmailTest
```

```

va_eventd.@target[2].from=from@example.com (<.from%3Dfrom@example.com>)
va_eventd.@target[2].to=to@example.com (<.to%3Dto@example.com>)

va_eventd.@target[2].subject_template=%{serial} %{severityName} %{eventName}!!!
va_eventd.@target[2].body_template=%{eventName} (%{class}:%{subclass}) happened!
va_eventd.@target[2].smtp_addr=192.168.100.3:25
va_eventd.@target[2].smtp_user=root
va_eventd.@target[2].smtp_password=admin
va_eventd.@target[2].use_tls=0
va_eventd.@target[2].tls_starttls=0
va_eventd.@target[2].tls_forcessl3=0
va_eventd.@forwarding[2]=forwarding
va_eventd.@forwarding[2].enabled=yes
va_eventd.@forwarding[2].className=power
va_eventd.@forwarding[2].eventName=IgnitionOff
va_eventd.@forwarding[2].severity=notice-notice
va_eventd.@forwarding[2].target=EmailTarget

#Sample SMS
va_eventd.@target[3]=target
va_eventd.@target[3].name=SMStarget
va_eventd.@forwarding[3].target=SMStarget
va_eventd.@target[3].type=sms
va_eventd.@target[3].template=%{serial} %{severityName} %{eventName}!!!
va_eventd.@target[3].callee=0123456789
va_eventd.@forwarding[3]=forwarding
va_eventd.@forwarding[3].enabled=yes
va_eventd.@forwarding[3].target=SMStarget
va_eventd.@forwarding[3].className=auth
va_eventd.@forwarding[3].eventName=LoginSSH
va_eventd.@forwarding[3].severity=notice-notice

#Sample Execute
va_eventd.@target[4]=target
va_eventd.@target[4].name=ExecTarget
va_eventd.@target[4].type=exec
va_eventd.@target[4].cmd_template=logger -t eventer %{eventName}
va_eventd.@forwarding[4]=forwarding
va_eventd.@forwarding[4].enabled=yes

```

```
va_eventd.@forwarding[4].target=ExecTarget
va_eventd.@forwarding[4].className=ppp
va_eventd.@forwarding[4].severity=debug-error

#Sample File
va_eventd.@target[5]=target
va_eventd.@target[5].name=FileTarget
va_eventd.@target[5].type=file
va_eventd.@target[5].file_name=\tmp\eventfile
va_eventd.@target[5].max_size_kb=1028
va_eventd.@forwarding[5]=forwarding
va_eventd.@forwarding[5].enabled=yes
va_eventd.@forwarding[5].target=FileTarget
va_eventd.@forwarding[5].severity=debug-error
```

Event system using package options

```
root@VA_router:~# uci export
va_eventd package va_eventd

config va_eventd 'main'
option event_queue_file '/tmp/event_buffer'
option event_queue_size '128K'

# Sample SNMP
config conn_tester
option type 'ping'
option ping_dest_addr '192.168.100.1'
option ping_success_duration_sec '60'
option name 'SNMPTest'
option ping_source 'LAN1'

config target
option suppress_duplicate_forwardings 'no'
option type 'snmp'
option agent_addr 'localhost'
option name 'SNMPTarget'
option conn_tester 'SNMPTest'
option target_addr '192.168.100.126:68'
option snmp_version '3'
option snmp_uname 'v3username'
option snmp_auth_proto 'MD5'
```

```
option snmp_auth_pass 'md5password'
option snmp_priv_proto 'AES'
option snmp_priv_pass 'aespassword'
option snmp_context 'v3context'
option snmp_context_eid 'v3contextID'
option snmp_sec_eid 'v3SecurityID'

config forwarding
option enabled 'yes'

option className 'mobile'
option severity 'notice-notice'
option target 'SNMPTarget'
option eventname 'LinkUp'

# Sample Syslog
config conn_tester
option name 'SyslogTest'
option type 'ping'
option ping_dest_addr '192.168.100.2'
option ping_source 'LAN1'
option ping_success_duration_sec '60'

config target
option name 'SyslogTarget'
option type 'syslog'
option conn_tester 'SyslogTest'
option target_addr '192.168.100.2:514'
option tcp_syslog '0'
```

```

config forwarding
option enabled 'yes'
option severity 'debug-error'
option target 'SyslogTarget'

# Sample Email
config conn_tester
option name 'EmailTest' option type 'link'
option link_iface 'PoAADSL'

config target
option timeout_sec '10'
option name 'EmailTarget'
option type 'email'
option conn_tester 'EmailTest'
option from 'from@example.com'
option to 'to@example.com'
option subject_template '%{serial} %{severityName} %{eventName}!!!'
option body_template '%{eventName} (%{class}:%{subclass}) happened!'
option smtp_addr '192.168.100.3:25'
option smtp_user 'root'
option smtp_password 'admin'
option use_tls 'no'
option tls_starttls 'no'
option tls_forcessl3 'no'

config forwarding
option enabled 'yes'
option target 'EmailTarget'
option className 'power'
option eventName 'IgnitionOff'
option severity 'notice-notice'

```



```

# Sample SMS
config target
option name 'SMSTarget'
option type 'sms'
option template '%{serial} %{severityName} %{eventName}!!!' option callee '0123456789'

config forwarding
option enabled 'yes'
option target 'SMSTarget'
option className 'auth'
option eventName 'LoginSSH'
option severity 'notice-notice'

# Sample Execute
config target
option name 'ExecTarget'
option type 'exec'
option cmd_template 'logger -t eventer %{eventName}'

config forwarding
option enabled 'yes'
option target 'ExecTarget'
option className 'ppp'
option severity 'debug-error'

# Sample File
config target
option name 'FileTarget'
option type 'file'
option file_name '\tmp\eventfile'
option max_size_kb '1028'

config forwarding
option enabled 'yes'
option target 'FileTarget'
option severity 'debug-error'

```

39.7. Event System Diagnostics

To view a list of all available class names, events and severity levels, enter:

```
root@VA_router:~# vae_cli -d
```

The following is an example of the output from this command:

Class	ID	Name	Severity	Specific Template
internal	1	EventdConfigErr	error	%{p1} %{p2}: %{p3} has bad value..
internal	2	EventdConfigWarn	warning	%{p1} %{p2}: %{p3} has bad value
internal	3	EventdConfigUnknown	informat	%{p1} %{p2}: field '%{p3}' is no
internal	4	EventdSystemErr	error	%{p1} %{p2}: %{p3} %{p4} %{p5} %
internal	5	EventdSystemWarn	error	%{p1} %{p2}: %{p3} %{p4} %{p5} %
internal	6	EventdUpAndRunning	informat	
internal	7	EventdStopped	warning	%{p1}
mobile	1	SIMin	notice	SIM card #%{p1} inserted
mobile	2	SIMout	notice	SIM card #%{p1} removed
mobile	3	LinkUp	notice	3g link %{p1} up using sim #%{p2}
mobile	4	LinkDown	notice	3g link %{p1} down
mobile	5	SMSByPassword	notice	Received SMS from %{p1} (by pass
mobile	6	SMSByCaller	notice	Received SMS from %{p1} (%{p2}):
mobile	7	SMSFromUnknown	warning	Received SMS from unknown sender
mobile	8	SMSSendSuccess	informat	SMS send success: %{p1}
mobile	9	SMSSendError	warning	SMS send error: %{p1}
mobile	10	SMSSent	notice	Sent SMS to %{p1}: %{p2}
ethernet	1	LinkUp	notice	Ethernet %{p1} up
ethernet	2	LinkDown	notice	Ethernet %{p1} down
auth	2	BadPasswordSSH	warning	SSH login attempt from %{p2}: ba
auth	3	BadUserConsole	warning	Console login attempt on %{p1}:
auth	4	BadPasswordConsole	warning	Console login attempt on %{p2}:
auth	5	BadUserTelnet	warning	Telnet login attempt bad username
auth	6	BadPasswordTelnet	warning	Telnet login attempt bad passwo.
auth	7	BadUserLuCl	warning	LuCl login attempt bad username
auth	8	BadPasswordLuCl	warning	LuCl login attempt bad password.
auth	9	Login SSH	notice	SSH login: user%{p2}from %{p3}
auth	10	LogoffSSH	notice	SSH logoff: user %{p1} due to %
auth	11	LoginConsole	notice	Console login: user %{p1} on %{p2}
auth	12	LoginConsole	notice	Console logoff on %{p1}
auth	13	LoginTelnet	notice	Telnet login: user %{p1}
auth	14	LoginLuCl	notice	LuCl login: user %{p1}
auth	15	ConsoleCommand	informat	%{p1}@%{p2}%{p3}
auth	16	LuClAction	informat	%{p1}@%{p2}%{p3}{p4}{p5}
ipsec	6	IPSecInitIKE	informat	IPSec IKE %{p1} established
ipsec	7	IPSecInitSA	informat	IPSec IKE %{p1} established
ipsec	8	IPSecCloseIKE	informat	IPSec IKE %{p1} deleted
ipsec	9	IPSecCloseSA	informat	IPSec SA %{p1} closed
ipsec	10	IPSecDPDTimeout	informat	IPSec IKE %{p1} DPD established
wifi	1	WiFiConnectedToAp	notice	WiFi %{p1} connected to AP %{p2}
wifi	2	WiFiDisconnectedFromAP	notice	WiFi %{p1} disconnected from AP
wifi	3	WiFiStationAttached	notice	WiFi station %{p2} connected to ..
wifi	4	WiFiStationDetached	notice	WiFi station %{p2} disconnected ..
wifi	5	WiFiStationAttachFailed	notice	WiFi station %{p2} failed to con..
ppp	1	LinkUp	informat	PPP for interface %{p2} (protoco..

pp	2	LinkDown	informat	PPP for interface %{p2} (protoco..
ppp	3	ConnEstablished	informat	PPP connection for interface %{p..
adsl	1	LinkUp	notice	ADSL trained. Starting interface..
adsl	2	LinkDown	notice	ADSL down. Stopping interface %{}..
adsl	3	Silent	debug	ADSL silent
adsl	4	Training	debug	ADSL training
adsl	5	TrainingSuccess	notice	ADSL training successful: data ..
system	1	BootSuccess	informat	Success booting into %{p1}
system	2	DigitalInputChange	notice	Digital Input %{p1} changed valu..
ntp	1	InitialSync	notice	Initial NTP sync: time: %{p1}; o..
ntp	2	Adjust	nformat	NTP adjust by %{p1}
ntp	3	QueryTimeout	warning	NTP query to %{p1} timed out. Ne..
ntp	4	QueryFailed	warning	NTP query failed: %{p1}

40. Configuring Data Usage Monitor

Merlin software provides support for monitoring of data usage on mobile interfaces and to disable if the monthly limit is exceeded. This allows an element of control over data usage for SIMs with a limited data plan.



NOTICE

DISCLAIMER: data usage statistics calculated by this data usage feature are best estimates and may vary from the mobile carrier statistics that are used for billing. Westermo cannot be held liable for any fees charged by the carrier to the customer for their data usage. We recommend that the configured data usage is lower than the allowance and that traffic percentage alerts are used.

Configuration Package Used

Package	Sections
procrustes	limit

40.1. Configuring Data Using The Web Interface

Select **Services** -> **Data Usage**. The Data Usage page appears.

Procrustes
Monitor network traffic for interface groups and stop interfaces and blacklist sim cards if limits are reached

Interface Group
This section contains no values yet

wan

The data usage page

You can monitor interfaces as a collective group, so enter a name for the group and select **Add**. The examples below show a group name configured as 'wan'.

You can configure multiple groups.

Procrustes
Monitor network traffic for interface groups and stop interfaces and blacklist sim cards if limits are reached

Interface Group Delete

WAN

Enabled DISCLAIMER: By clicking Enabled you agree that data presented are estimates and may vary from what your carrier uses for billing. Virtual Access cannot be held liable for any fees charged by the carrier to the customer for their data usage. We recommend that you set the configured data usage lower than the allowance and also use traffic alerts.

Interfaces lan: lan1: (no interfaces attached) loopback: wan: wfan: wfan1:

Billing Start Day of month when billing period starts (1-28)

Monthly Limit (MB) 0 means "no limit"

Monthly Warnings (MB) When usage would reach any of these levels, message will be sent

The data usage configuration page

Web Field/UCI/Package Option	Description				
Web: Enabled UCI: procrustes.@limit[0].enabled Opt: enabled	Enable data usage monitor on this interface group. <table border="1"> <tr> <td>Default: 0</td> <td>Disabled</td> </tr> <tr> <td>1</td> <td>Enabled</td> </tr> </table>	Default: 0	Disabled	1	Enabled
Default: 0	Disabled				
1	Enabled				
Web: Billing Start UCI: procrustes.@limit[0].billing_period_start_day Opt: billing_period_start_day	Day of month on which the billing period starts. <table border="1"> <tr> <td>Default: 0</td> <td>Zero means no limit</td> </tr> </table>	Default: 0	Zero means no limit		
Default: 0	Zero means no limit				
Web: Interfaces UCI: procrustes.@limit[0].interfaces Opt: interfaces	Monitor and apply limits to these interfaces as a group. Configure multiple interfaces via UCI using a space separator. Example: <pre>uci set procrustes.@limit[0].interfaces="lan wan"</pre>				
Web: Monthly Limit (MB) UCI: procrustes.@limit[0].monthly_data_limit Opt: monthly_data_limit	Defines monthly data traffic limit in megabytes (MB). This is total RX and TX on the interface. <table border="1"> <tr> <td>Default: 0</td> <td>Zero means no limit</td> </tr> </table>	Default: 0	Zero means no limit		
Default: 0	Zero means no limit				
Web: Monthly Warnings (MB) UCI: procrustes.@limit[0].monthly_warning_levels Opt: monthly_warning_levels	Defines data usage limits for generating a log message and a VA event alert when used traffic reaches specified levels. Levels are specified in MB. Set multiple limits via UCI using a space separator. Example: <pre>uci set procrustes.@limit[0].monthly_warning_levels="15 25"</pre> <table border="1"> <tr> <td>Default: 0</td> <td>Zero means no limit</td> </tr> </table>	Default: 0	Zero means no limit		
Default: 0	Zero means no limit				

40.2. Configuring Data Using Command Line

Data usage is configured under the **procrustes** package `/etc/config/procrustes`.

By default, all limit instances are named 'limit', and are identified by `@limit` followed by the limit position in the package as a number. For example, for the first limit in the package using UCI:

```
procrustes.@limit[0]=limit
procrustes.@limit[0].enabled=1
```

Or using package options, enter:

```
config limit
option enabled '1'
```

However, to better identify instances, it is recommended to give the limit instance a name. For example, create a limit instance named **MOBILE1**.

To define a named limit instance using UCI, enter:

```
procrustes.@limit[0]=wan
procrustes.wan.enabled=1
```

To define a named limit instance using package options, enter:

```
config limit 'wan'
option enabled '1'
```

The following examples show two limit groups wan and lan.

Procrustes using UCI

```
root@VA_router:~# uci show procrustes
procrustes.lan=limit
procrustes.lan.enabled=1
procrustes.lan.interfaces=LAN1
procrustes.lan.billing_period_start_day=1
procrustes.lan.monthly_data_limit=30
procrustes.lan.monthly_warning_levels=15 25
procrustes.wan=limit
procrustes.wan.enabled=1
procrustes.wan.interfaces=MOBILE1
procrustes.wan.billing_period_start_day=1
procrustes.wan.monthly_data_limit=30
procrustes.wan.monthly_warning_levels=15 25
```

Procrustes using package options

```

root@VA_router:~# uci export procrustes
package procrustes

config limit 'lan'
option enabled '1'
option interfaces 'LAN1'
option billing_period_start_day '1'
option monthly_data_limit '30'
option monthly_warning_levels '15 25'

config limit 'wan'
option enabled '1'
option interfaces 'MOBILE1'
option billing_period_start_day '1'
option monthly_data_limit '30'
option monthly_warning_levels '15 25'

```

40.3. Data Usage Diagnostics

Data Usage Status using the Web Interface

Select **Status -> Overview**. The Status page appears.

To check current data usage, scroll to **Network -> Data Usage (MiB)** row. Data usage is presented as progress bar.

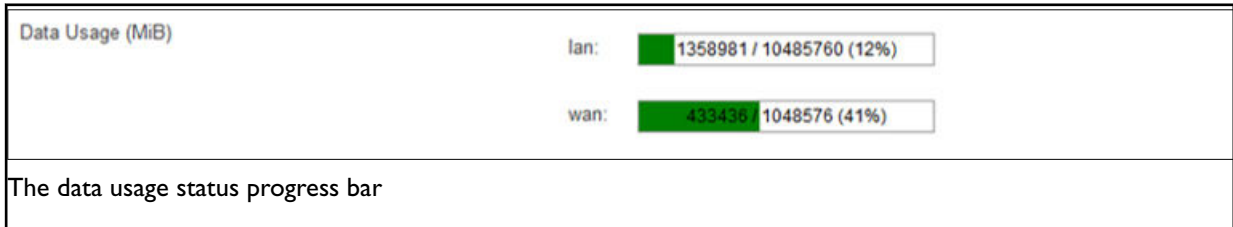

Syslog Events

The following events can be generated in logs by the data usage feature:

Severity	Tag	Text
NOTICE	procrustes	<if_group_name>: using counter 1404674 saved on 2017-09-30 16:26:57
NOTICE	procrustes	<if_group_name>: warning level 2097152 is reached
WARNING	procrustes	<if_group_name>: hard limit 10485760 is reached

NOTICE	procrustes	Data limit on SIM <iccid> exceeded and sim will be banned until the next month
ERROR	procrustes	Could not get iccid for <ifname>
DEBUG	procrustes	Interface <ifname> is not up
WARNING	procrustes	network.<ifname>.ifname is not defined
NOTICE	procrustes	<ifname>: reached billing start. Resetting..
DEBUG	procrustes	Saving current limit values
NOTICE	procrustes	<if_group_name>: not enabled
WARNING	procrustes	<if_group_name>: defines no interfaces
DEBUG	procrustes	<if_group_name>: sim interface <ifname>
ERROR	procrustes	Daemonization failed
ERROR	procrustes	another procrustes is running. Exiting..
NOTICE	procrustes	No limits defined. Exiting..
ERROR	mobile	SIM <iccid> is blacklisted, not establishing connection

Viewing Data Usage

The router has a monitoring application named `procrustatus.lua` that can be used for viewing data usage.

This application displays data statistics used for different interface groups, percentage of time left to next billing period start and percentage of data left for use before the interface will be shut down.

To view the application, enter the command `procrustes.lua`

```
root@VA_router:~# procrustatus.lua
```

name	current	max	time left	data left
lan:	1404674/	10485760	1.03%	86.60%
wan:	433436/	1048576	1.03%	58.66%

Alternatively, to check total data usage, enter:

```
root@VA_router:~# cat /var/state/procrustes
procrustes.lan.total_bytes=215780
procrustes.wan.total_bytes=433436
```

Additional Debugging Commands

Additional useful debugging commands via the command line are described in the table below.

Diagnostic Command	Description
<code>logread grep procrustes</code>	Shows logs related to "procrustes" only
<code>is /root/procrustes/sim_blacklist/</code>	Shows list of blacklisted SIM iccids

41. Configuring Terminal Server

Overview

Terminal server is a background application whose main task is to forward data between TCP connections or UDP streams and asynchronous or synchronous serial ports.

The terminal server application serves up to four sessions simultaneously, one for each serial port, depending on the device. Each terminal server session has an IP endpoint and an associated specific serial port.

You can configure the IP endpoint of each terminal server session to be a:

- TCP server: each session is listening on a unique port.
- TCP client: the terminal server makes a TCP connection to external TCP server.
- UDP endpoint: the terminal server forwards data between a UDP stream and a serial port.

Configuration packages used

Package	Sections
tservd	main
	port

41.1. Configuring Terminal Server Using The Web Interface

In the top menu, select **Services -> Terminal Server**. The Terminal Server Configuration page appears. You must configure two sections:

- Main Settings are to enable the terminal server, syslog settings, and to enable log setting.
- The Port Settings section is for general port settings, serial settings such as port mode, port speed, parity stop bit and so on. And finally, network settings to configure the network side of the terminal server.

Configure Main Settings

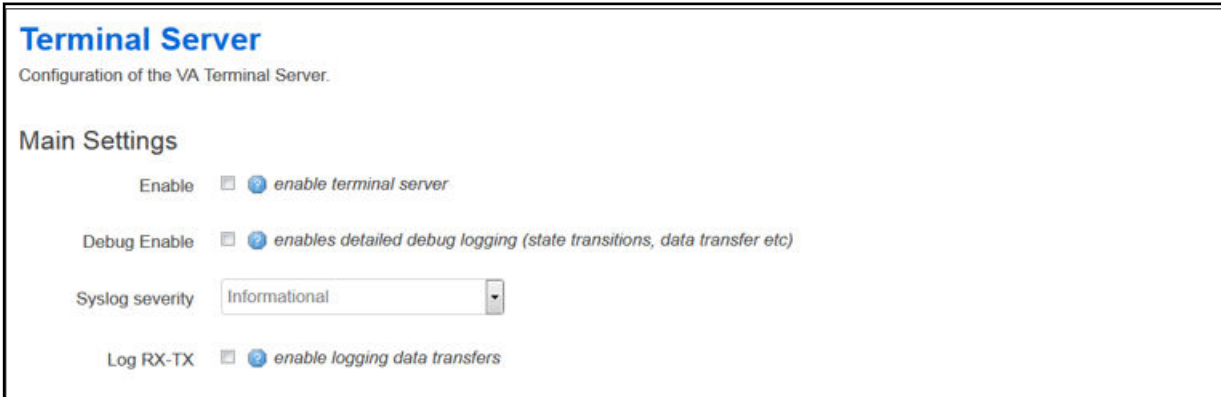

The screenshot shows the 'Terminal Server' configuration page. The title is 'Terminal Server' and the subtitle is 'Configuration of the VA Terminal Server.' Under the 'Main Settings' section, there are four settings: 'Enable' with a checked checkbox and a help icon, 'Debug Enable' with an unchecked checkbox and a help icon, 'Syslog severity' with a dropdown menu set to 'Informational', and 'Log RX-TX' with a checked checkbox and a help icon.

The terminal server main settings page

Web Field/UCI/Package Option	Description																
Web: Enable UCI: tsservd.main.enable Opt: enable	Enables Terminal Server on the router. <table border="1"> <tr> <td>Default: 0</td> <td>Disabled</td> </tr> <tr> <td>1</td> <td>Enabled</td> </tr> </table>	Default: 0	Disabled	1	Enabled												
Default: 0	Disabled																
1	Enabled																
Web: Debug Enable UCI: tsservd.main.debug_ev_enable Opt: debug_ev_enable	Enables detailed debug logging. <table border="1"> <tr> <td>Default: 0</td> <td>Disabled</td> </tr> <tr> <td>1</td> <td>Enabled</td> </tr> </table>	Default: 0	Disabled	1	Enabled												
Default: 0	Disabled																
1	Enabled																
Web: Syslog severity UCI: tsservd.main.log_severity Opt: log_severity	Determines the syslog level. Events up to this priority will be logged. <table border="1"> <tr> <td>0</td> <td>Emergency</td> </tr> <tr> <td>1</td> <td>Alert</td> </tr> <tr> <td>2</td> <td>Critical</td> </tr> <tr> <td>3</td> <td>Error</td> </tr> <tr> <td>4</td> <td>Warning</td> </tr> <tr> <td>5</td> <td>Notice</td> </tr> <tr> <td>6</td> <td>Informational</td> </tr> <tr> <td>7</td> <td>Debug</td> </tr> </table>	0	Emergency	1	Alert	2	Critical	3	Error	4	Warning	5	Notice	6	Informational	7	Debug
0	Emergency																
1	Alert																
2	Critical																
3	Error																
4	Warning																
5	Notice																
6	Informational																
7	Debug																
Web: Log RX-TX UCI: tsservd.main.debug_rx_tx_enable Opt: debug_rx_tx_enable	Enables logging data transfers. <table border="1"> <tr> <td>Default: 0</td> <td>Disabled</td> </tr> <tr> <td>1</td> <td>Enabled</td> </tr> </table>	Default: 0	Disabled	1	Enabled												
Default: 0	Disabled																
1	Enabled																

41.1.1. Configuring Port Settings

The Port Settings section is divided into 3 sub-sections:

- General
- Serial
- Network

Port Settings: General Section

In this section you can configure general port settings. The settings are usually the same for the central and the remote site.

Port Settings

PORT1

General

Serial

Network

Enable [enable port](#)

Network Forwarding Buffer Size [Forwarding buffer size \(serial to network\)](#)

Network Forwarding Timeout (ms) [Forwarding timeout in milliseconds \(serial to network\)](#)

Network Forwarding timer mode [Forwarding timer mode \(serial to network\)](#)

Serial Forwarding Buffer Size [Forwarding buffer size \(network to serial\)](#)

Serial Forwarding Timeout (ms) [Forwarding timeout in milliseconds \(network to serial\)](#)

Serial Forwarding timer mode [Forwarding timer mode \(network to serial\)](#)

Proxy mode [enable proxy mode](#)

Disable remote client's local echo (Telnet option)

Telnet COM port control (RFC2217)

Enable HDLC Pseudowire over UDP (RFC4618)

Serial receive debug log size [bytes \(0=disable\)](#)

Serial transmit debug log size [bytes \(0=disable\)](#)

The port settings general section

Web Field/UCI/Package Option	Description				
Web: Enable UCI: tsvrld.@port[0].enable Opt: enable	Enables terminal server port. <table border="1"> <tr> <td>Default: 0</td> <td>Disabled</td> </tr> <tr> <td>1</td> <td>Enabled</td> </tr> </table>	Default: 0	Disabled	1	Enabled
Default: 0	Disabled				
1	Enabled				
Web: Network Forwarding Buffer Size UCI: tsvrld.@port[0].fwd_buffer_size Opt: fwd_buffer_size	Forwarding buffer size in bytes (serial to network). <table border="1"> <tr> <td>Default:</td> <td>256 bytes</td> </tr> <tr> <td>Range</td> <td>0-2048</td> </tr> </table>	Default:	256 bytes	Range	0-2048
Default:	256 bytes				
Range	0-2048				
Web: Network Forwarding Timeout(ms) UCI: tsvrld.@port[0].fwd_timeout Opt: fwd_timeout	Forwarding timeout in milliseconds (serial to network). <table border="1"> <tr> <td>Default:</td> <td>30ms</td> </tr> <tr> <td>Range</td> <td>0-10000</td> </tr> </table>	Default:	30ms	Range	0-10000
Default:	30ms				
Range	0-10000				
Web: Network Forwarding Timer Mode UCI: tsvrld.@port[0].fwd_timer_mode Opt: fwd_timer_mode	Forwarding timer mode (serial to network). <table border="1"> <tr> <td>Default: Idle</td> <td>Timer is restarted on each received data.</td> </tr> <tr> <td>Aging</td> <td>Timer is started on the first Rx.</td> </tr> </table>	Default: Idle	Timer is restarted on each received data.	Aging	Timer is started on the first Rx.
Default: Idle	Timer is restarted on each received data.				
Aging	Timer is started on the first Rx.				
Web: Serial Forwarding Buffer Size UCI: tsvrld.@port[0].sfwd_buffer_size Opt: sfwd_buffer_size	Forwarding buffer size in bytes (network to serial). Set to 0 to use maximum possible network Rx buffer size. <table border="1"> <tr> <td>Default:</td> <td>20ms</td> </tr> <tr> <td>Range</td> <td>0-10000</td> </tr> </table>	Default:	20ms	Range	0-10000
Default:	20ms				
Range	0-10000				
Web: Serial Forwarding Timeout (ms) UCI: tsvrld.@port[0].sfwd_timeout Opt: sfwd_timeout	Forwarding timeout in milliseconds (network to serial). Set to 0 to forward to serial immediately. <table border="1"> <tr> <td>Default:</td> <td>20ms</td> </tr> <tr> <td>Range</td> <td>0-10000</td> </tr> </table>	Default:	20ms	Range	0-10000
Default:	20ms				
Range	0-10000				
Web: Serial Forwarding Timer Mode UCI: tsvrld.@port[0].sfwd_timer_mode Opt: sfwd_timer_mode	Forwarding timer mode (network to serial). <table border="1"> <tr> <td>Default: Idle</td> <td>Timer is restarted on each received data.</td> </tr> <tr> <td>Aging</td> <td>Timer started on the first Rx.</td> </tr> </table>	Default: Idle	Timer is restarted on each received data.	Aging	Timer started on the first Rx.
Default: Idle	Timer is restarted on each received data.				
Aging	Timer started on the first Rx.				
Web: Proxy Mode UCI: tsvrld.@port[0].proxy_mode Opt: proxy_mode	Defines if a special proxy mode should be configured to allow 'hijacking' of the terminal server. It allows a connection to be made from a remote location and redirect terminal server data temporarily for troubleshooting. When enabled, a TCP proxy server is started which listens for an incoming TCP connection from a remote peer. Once an incoming new TCP connection on the proxy server TCP port is accepted: <ul style="list-style-type: none"> • The existing terminal server TCP client connection is disconnected. • The terminal server automatically reconnects the TCP client side but this time to the local loopback address 127.0.0.1 and to the local proxies TCP port number. • When the proxy server has both local and remote TCP sessions connected it simply forwards the data between the two connections, taking into account the flow control. • When either side TCP socket closes, the main terminal server client reconnects to the normal IP destination and the server proxy returns to listening for another connection from the far end. <table border="1"> <tr> <td>Default: 0</td> <td>Disabled</td> </tr> <tr> <td>1</td> <td>Enabled</td> </tr> </table>	Default: 0	Disabled	1	Enabled
Default: 0	Disabled				
1	Enabled				
Web: Disable Remote Client's Local Echo (Telnet option)	Set to 1 to send IAC WILL ECHO Telnet option to remote client forcing it to disable local echo. For server mode only.				

UCI: tservd.@port[0].disable_echo Opt: disable_echo	<table border="1"> <tr><td>Default: 0</td><td>Disabled</td></tr> <tr><td>1</td><td>Enabled</td></tr> </table>	Default: 0	Disabled	1	Enabled
Default: 0	Disabled				
1	Enabled				
Web: Telnet COM Port Control UCI: tservd.@port[0].com_port_control Opt: com_port_control	<p>Set to 1 to enable support for Telnet COM port control (RFC2217).</p> <table border="1"> <tr><td>Default: 0</td><td>Disabled</td></tr> <tr><td>1</td><td>Enabled</td></tr> </table>	Default: 0	Disabled	1	Enabled
Default: 0	Disabled				
1	Enabled				
Web: Enable HDLC Pseudowire over UDP (RFC4618) UCI: tservd.@port[0].hdlc_pw_enabled Opt: hdlc_pw_enabled	<p>Set to 1 to enable HDLC pseudowire over UDP support based on RFC4618. Requires Transport Mode (udpmode) to be enabled.</p> <table border="1"> <tr><td>Default: 0</td><td>Disabled</td></tr> <tr><td>1</td><td>Enabled</td></tr> </table>	Default: 0	Disabled	1	Enabled
Default: 0	Disabled				
1	Enabled				
Web: Serial Receive Debug Log Size UCI: tservd.@port[0].serialRxLogSize Opt: serialRxLogSize	<p>Configures serial receive log size in bytes and enables receive data logging.</p> <table border="1"> <tr><td>Default: 0</td><td>Disabled</td></tr> <tr><td>1</td><td>Enabled</td></tr> </table>	Default: 0	Disabled	1	Enabled
Default: 0	Disabled				
1	Enabled				
Web: Serial Transmit Debug Log Size UCI: tservd.@port[0].serialTxLogSize Opt: serialTxLogSize	<p>Configures serial transmit log size in bytes and enables transmit data logging.</p> <table border="1"> <tr><td>Default: 0</td><td>Disabled</td></tr> <tr><td>1</td><td>Enabled</td></tr> </table>	Default: 0	Disabled	1	Enabled
Default: 0	Disabled				
1	Enabled				

Port Settings: Serial Section

In this section you can configure serial interface settings, such as port mode, port speed, parity strip bit and so on.



NOTE

The displayed settings vary depending on options selected.

The figure below shows the options available if you have selected RS232 mode.

Port Settings

PORT1

General **Serial** Network

Enable [enable port](#)

Network Forwarding Buffer Size [Forwarding buffer size \(serial to network\)](#)

Network Forwarding Timeout (ms) [Forwarding timeout in milliseconds \(serial to network\)](#)

Network Forwarding timer mode [Forwarding timer mode \(serial to network\)](#)

Serial Forwarding Buffer Size [Forwarding buffer size \(network to serial\)](#)

Serial Forwarding Timeout (ms) [Forwarding timeout in milliseconds \(network to serial\)](#)

Serial Forwarding timer mode [Forwarding timer mode \(network to serial\)](#)

Proxy mode [enable proxy mode](#)

Disable remote client's local echo (Telnet option)

Telnet COM port control (RFC2217)

Enable HDLC Pseudowire over UDP (RFC4618)

Serial receive debug log size [bytes \(0=disable\)](#)

Serial transmit debug log size [bytes \(0=disable\)](#)

The serial section fields (port mode RS232)

The figure below shows the options available if you have selected RS485 mode.

PORT2

General Serial **Network**

Device: serial device name

Portmode: serial interface mode

GPIO Control: use GPIO pin to set the port mode

Speed (bps): asynchronous baud rate

Word size: serial device word size in bits

Parity: serial device parity in bits

Stop bits: serial device number of stop bits

Flow Control: serial device flow control type

RS485 termination: enable RS485 line termination

Auto RTS Invert: invert RTS in auto-RTS mode

Keep serial port always open: keep serial port always activated

RTS timeout: RS232 half duplex mode RTS timeout in milliseconds

POST RTS timeout: RS232 half duplex mode Post RTS timeout in milliseconds

Serial device idle timeout: Serial device idle timeout in seconds

The serial section fields (port mode RS485)

The figure below shows the options available if you have selected X.21 mode.

PORT1

General

Serial

Network

Device	<input type="text" value="/dev/ttySC0"/>	serial device name
Portmode	<input type="text" value="X.21"/>	serial interface mode
GPIO Control	<input type="checkbox"/>	use GPIO pin to set the port mode
Keep serial port always open	<input checked="" type="checkbox"/>	keep serial port always activated
Serial device idle timeout	<input type="text" value="0"/>	Serial device idle timeout in seconds
Synchronous mode	<input type="text" value="HDLC"/>	synchronous mode
DTR control mode	<input type="text" value="auto"/>	DTR output control mode
RTS control mode	<input type="text" value="auto"/>	RTS output control mode
Synchronous rate	<input type="text" value="64000"/>	synchronous baud rate
Invert receive clock	<input type="checkbox"/>	enable receive clock inversion
Invert transmit clock	<input type="checkbox"/>	enable transmit clock inversion
RX MSBF	<input type="checkbox"/>	receive most significant bit first
TX MSBF	<input type="checkbox"/>	transmit most significant bit first
RX data delay	<input type="text" value="0"/>	Rx data delay in bit positions
TX data delay	<input type="text" value="0"/>	Tx data delay in bit positions
Dual X.21 card bit reverse	<input type="checkbox"/>	
Dual X.21 card DTE TT Invert	<input type="checkbox"/>	
Dual X.21 card DCE TCLK Invert	<input type="checkbox"/>	
Dual X.21 card DCE RCLK Invert	<input type="checkbox"/>	
Dual X.21 card CLK Invert	<input type="checkbox"/>	
Dual X.21 card RX data delay	<input type="text" value="0"/>	

Delete

The serial section fields (port mode X.21)

Web Field/UCI/Package Option	Description										
Web: Device UCI: tservd.@port[0].devName Opt: devName	Serial device name. <table border="1"> <tr> <td>Default: /dev/ttySC0</td> <td>serial port 1</td> </tr> <tr> <td>/dev/ttySC1</td> <td>serial port 2</td> </tr> <tr> <td>/dev/ttySC2</td> <td>serial port 3</td> </tr> <tr> <td>/dev/ttySC3</td> <td>serial port 4</td> </tr> </table>	Default: /dev/ttySC0	serial port 1	/dev/ttySC1	serial port 2	/dev/ttySC2	serial port 3	/dev/ttySC3	serial port 4		
Default: /dev/ttySC0	serial port 1										
/dev/ttySC1	serial port 2										
/dev/ttySC2	serial port 3										
/dev/ttySC3	serial port 4										
Web: Port mode UCI: tservd.@port[0].port_mode Opt: port_mode	Sets the serial interface mode. <table border="1"> <tr> <td>Default: rs232</td> <td>RS232 mode</td> </tr> <tr> <td>rs485hdx</td> <td>RS485 2-wire half-duplex mode in which the transmitter drives the RTS.</td> </tr> <tr> <td>rs485fdx</td> <td>RS485 4-wire full-duplex mode.</td> </tr> <tr> <td>v23</td> <td>Uses V.23 leased line card driver.</td> </tr> <tr> <td>x21</td> <td>Uses USB serial card in sync mode.</td> </tr> </table>	Default: rs232	RS232 mode	rs485hdx	RS485 2-wire half-duplex mode in which the transmitter drives the RTS.	rs485fdx	RS485 4-wire full-duplex mode.	v23	Uses V.23 leased line card driver.	x21	Uses USB serial card in sync mode.
Default: rs232	RS232 mode										
rs485hdx	RS485 2-wire half-duplex mode in which the transmitter drives the RTS.										
rs485fdx	RS485 4-wire full-duplex mode.										
v23	Uses V.23 leased line card driver.										
x21	Uses USB serial card in sync mode.										
Web: GPIO Control UCI: tservd.@port[1].serial_mode)gpio_control Opt: serial_mode_gpio_control	Enables or disables software control of the port mode between RS232 and RS485. Applies only to port 1 (ttySC1) and not to port 0. Note: the port mode is set with the option port mode described above. <table border="1"> <tr> <td>Default: 0</td> <td>Port mode is configurable by hardware settings and is not user configurable. Set to 0 for port 0.</td> </tr> <tr> <td>1</td> <td>Enabled. Port mode is configurable by software settings. This is applicable to serial port 1 on devices that are capable of RS485.</td> </tr> </table>	Default: 0	Port mode is configurable by hardware settings and is not user configurable. Set to 0 for port 0.	1	Enabled. Port mode is configurable by software settings. This is applicable to serial port 1 on devices that are capable of RS485.						
Default: 0	Port mode is configurable by hardware settings and is not user configurable. Set to 0 for port 0.										
1	Enabled. Port mode is configurable by software settings. This is applicable to serial port 1 on devices that are capable of RS485.										
Web: Speed (bps) UCI: tservd.@port[0].speed Opt: speed	Serial device speed in baud (bps). <table border="1"> <tr> <td>Default:</td> <td>9600</td> </tr> <tr> <td>Range</td> <td>115200; 57600; 38400; 19200; 9600; 4800; 2400; 1800; 1200; 600; 300; 200; 150; 134; 110; 75; 50</td> </tr> </table>	Default:	9600	Range	115200; 57600; 38400; 19200; 9600; 4800; 2400; 1800; 1200; 600; 300; 200; 150; 134; 110; 75; 50						
Default:	9600										
Range	115200; 57600; 38400; 19200; 9600; 4800; 2400; 1800; 1200; 600; 300; 200; 150; 134; 110; 75; 50										
Web: Word size UCI: tservd.@port[0].wsize Opt: wsize	Serial device word size. <table border="1"> <tr> <td>Default:</td> <td>8</td> </tr> <tr> <td>Range</td> <td>5-8</td> </tr> </table>	Default:	8	Range	5-8						
Default:	8										
Range	5-8										
Web: Parity UCI: tservd.@port[0].parity Opt: parity	Serial device parity <table border="1"> <tr> <td>Default: 0</td> <td>None</td> </tr> <tr> <td>1</td> <td>Even</td> </tr> <tr> <td>2</td> <td>odd</td> </tr> <tr> <td>3</td> <td>Space</td> </tr> </table>	Default: 0	None	1	Even	2	odd	3	Space		
Default: 0	None										
1	Even										
2	odd										
3	Space										
Web: Stop Bits UCI: tservd.@port[0].stops Opt: stops	Serial device number of stop bits. <table border="1"> <tr> <td>Default: 1</td> <td></td> </tr> <tr> <td>Range</td> <td>1-2</td> </tr> </table>	Default: 1		Range	1-2						
Default: 1											
Range	1-2										
Web: Flow Control UCI: tservd.@port[0].fc_mode Opt: fc_mode	Serial flow control mode. <table border="1"> <tr> <td>Default: 0</td> <td>None</td> </tr> <tr> <td>1</td> <td>RTS/CTS</td> </tr> <tr> <td>2</td> <td>XON/XOFF</td> </tr> </table>	Default: 0	None	1	RTS/CTS	2	XON/XOFF				
Default: 0	None										
1	RTS/CTS										
2	XON/XOFF										
Web: RS485 Termination UCI: tservd.@port[0].rs485_line_termination Opt: rs485_line_termination	Enables or disables RS485 termination. Applies only if port mode is set to RS485. <table border="1"> <tr> <td>Default: 0</td> <td>Disabled</td> </tr> <tr> <td>1</td> <td>Enabled</td> </tr> </table>	Default: 0	Disabled	1	Enabled						
Default: 0	Disabled										
1	Enabled										
Web: Auto RTS Invert UCI: tservd.@port[0].rtsinvert	Invert RTS in auto-RTS mode, if port mode is set to RS485. <table border="1"> <tr> <td>Default: 0</td> <td>Disabled</td> </tr> </table>	Default: 0	Disabled								
Default: 0	Disabled										

Opt: rtsinvert	1	Enabled										
Web: Keep Serial Port Always Open UCI: tservd.@port[0].tty_always_open Opt: tty_always_open	Keep serial port always open.											
Web: RS232 Half Duplex UCI: tservd.@port[0].hd_mode Opt: hd_mode	Defines whether to enable special mode in the asynchronous serial driver for communication to an externally connected V.23 half-duplex modem. Note: this setting does not enable half-duplex mode in the serial hardware of the router. Default 30ms											
Web: RTS Timeout UCI: tservd.@port[0].rts_timeout Opt: rts_timeout	In RS232 half-duplex mode, time in milliseconds between raising RTS and enabling the transmitter. For use with an externally connected V.23 modem. Default 30ms											
Web: POST RTS Timeout UCI: tservd.@port[0].post_rts_timeout Opt: post_rts_timeout	In RS232 half-duplex mode, sets the time in milliseconds between dropping RTS (transmission finished) and enabling the receiver. For use with externally connected V.23 modem. Default 20ms											
Web: Synchronous mode UCI: tservd.@port[0].sync_mode Opt: sync_mode	Defines synchronous frame mode. This setting is only displayed if an Atmel USB serial card is enabled. Default: hdlc HDLC frame mode transp Transparent mode											
Web: Use CRC32 UCI: tservd.@port[0].sync_crc32 Opt: sync_crc32	Defines whether to use CRC32 or CRC16 in HDLC mode. This setting is only displayed if an Atmel USB serial card is enabled. Default: 0 Use CRC16 1 Use CRC32											
Web: DTR control mode UCI: tservd.@port[0].dtr_control_mode Opt: dtr_control_mode	Defines DTR line control modes. This setting is only displayed if an Atmel USB serial card is enabled and port mode is X21. <table border="1"> <tr> <td>Default: auto</td> <td>Defines DTR line control modes. This setting is only displayed if an Atmel USB serial card is enabled and port mode is X21.</td> </tr> <tr> <td>on</td> <td>DTR always on</td> </tr> <tr> <td>off</td> <td>DTR always off</td> </tr> <tr> <td>app</td> <td>DTR controlled by the application</td> </tr> <tr> <td>ontx</td> <td>In HDLC mode DTR is on during frame transmission.</td> </tr> </table>		Default: auto	Defines DTR line control modes. This setting is only displayed if an Atmel USB serial card is enabled and port mode is X21.	on	DTR always on	off	DTR always off	app	DTR controlled by the application	ontx	In HDLC mode DTR is on during frame transmission.
Default: auto	Defines DTR line control modes. This setting is only displayed if an Atmel USB serial card is enabled and port mode is X21.											
on	DTR always on											
off	DTR always off											
app	DTR controlled by the application											
ontx	In HDLC mode DTR is on during frame transmission.											
Web: RTS control mode UCI: tservd.@port[0].rts_control_mode Opt: rts_control_mode	Defines RTS line control modes. Only displayed if an Atmel USB serial card is enabled and port mode is X21. <table border="1"> <tr> <td>Default: auto</td> <td>Defines RTS line control modes. This setting is only displayed if an Atmel USB serial card is enabled and port mode is X21.</td> </tr> <tr> <td>on</td> <td>RTS always on</td> </tr> <tr> <td>off</td> <td>RTS always off</td> </tr> <tr> <td>app</td> <td>RTS controlled by the application</td> </tr> <tr> <td>ontx</td> <td>In HDLC mode RTS is on during frame transmission.</td> </tr> </table>		Default: auto	Defines RTS line control modes. This setting is only displayed if an Atmel USB serial card is enabled and port mode is X21.	on	RTS always on	off	RTS always off	app	RTS controlled by the application	ontx	In HDLC mode RTS is on during frame transmission.
Default: auto	Defines RTS line control modes. This setting is only displayed if an Atmel USB serial card is enabled and port mode is X21.											
on	RTS always on											
off	RTS always off											
app	RTS controlled by the application											
ontx	In HDLC mode RTS is on during frame transmission.											
Web: Synchronous rate UCI: tservd.@port[0].sync_speed Opt: sync_speed	Defines the synchronous speed in bps. Set to 0 for external clock. If not set to 0, an internal clock is used. This setting is only displayed if an Atmel USB serial card is enabled. <table border="1"> <tr> <td>Default: 64000</td> <td>64 kbps</td> </tr> <tr> <td>Range</td> <td>2048000; 1024000; 768000; 512000; 384000; 256000; 128000; 19200; 9600</td> </tr> </table>		Default: 64000	64 kbps	Range	2048000; 1024000; 768000; 512000; 384000; 256000; 128000; 19200; 9600						
Default: 64000	64 kbps											
Range	2048000; 1024000; 768000; 512000; 384000; 256000; 128000; 19200; 9600											

<p>Web: Invert receive clock</p> <p>UCI: tservd.@port[0].sync_invert_rxclk</p> <p>Opt: sync_invert_rxclk</p>	<p>Defines receive clock inversion. Normal clock data is sampled on falling edge. Inverted clock data is sampled on rising edge. This setting is only displayed if an Atmel USB serial card is enabled.</p> <table border="1"> <tr> <td>Default: 0</td> <td>Normal</td> </tr> <tr> <td>1</td> <td>Invert</td> </tr> </table>	Default: 0	Normal	1	Invert
Default: 0	Normal				
1	Invert				
<p>Web: Invert transmit clock</p> <p>UCI: tservd.@port[0].sync_invert_txclk</p> <p>Opt: sync_invert_txclk</p>	<p>Defines transmit clock inversion. Normal clock data transmitted on falling edge. Inverted clock data transmitted on rising edge. Only displayed if an Atmel USB serial card is enabled.</p> <table border="1"> <tr> <td>Default: 0</td> <td>Normal</td> </tr> <tr> <td>1</td> <td>Invert</td> </tr> </table>	Default: 0	Normal	1	Invert
Default: 0	Normal				
1	Invert				
<p>Web: RX MSBF</p> <p>UCI: tservd.@port[0].sync_rx_msbf</p> <p>Opt: sync_rx_msbf</p>	<p>Defines whether most significant bit is received first. This setting is only displayed if an Atmel USB serial card is enabled.</p> <table border="1"> <tr> <td>Default: 0</td> <td>Receive least significant bit first</td> </tr> <tr> <td>1</td> <td>Receive most significant bit first</td> </tr> </table>	Default: 0	Receive least significant bit first	1	Receive most significant bit first
Default: 0	Receive least significant bit first				
1	Receive most significant bit first				
<p>Web: TX MSBF</p> <p>UCI: tservd.@port[0].sync_tx_msbf</p> <p>Opt: sync_tx_msbf</p>	<p>Defines whether most significant bit is transmitted first. This setting is only displayed if an Atmel USB serial card is enabled.</p> <table border="1"> <tr> <td>Default: 0</td> <td>Transmit least significant bit first</td> </tr> <tr> <td>1</td> <td>Transmit most significant bit first</td> </tr> </table>	Default: 0	Transmit least significant bit first	1	Transmit most significant bit first
Default: 0	Transmit least significant bit first				
1	Transmit most significant bit first				
<p>Web: RX data delay</p> <p>UCI: tservd.@port[0].sync_rxdata_dly</p> <p>Opt: sync_rxdata_dly</p>	<p>Defines the number of bit positions to delay sampling data from the detecting clock edge. This setting is only displayed if an Atmel USB serial card is enabled.</p> <table border="1"> <tr> <td>Default</td> <td>0</td> </tr> </table>	Default	0		
Default	0				
<p>Web: TX data delay</p> <p>UCI: tservd.@port[0].sync_txdata_dly</p> <p>Opt: sync_txdata_dly</p>	<p>Defines the number of bit positions to delay the output of data from the detecting clock edge. This setting is only displayed if an Atmel USB serial card is enabled.</p> <table border="1"> <tr> <td>Default</td> <td>0</td> </tr> </table>	Default	0		
Default	0				
<p>Web: Dual X.21 card bit reverse</p> <p>UCI: tservd.@port[0].bit_reverse</p> <p>Opt: bit_reverse</p>	<p>Enables bit reversal of all bits in 8 byte word during transmission.</p> <table border="1"> <tr> <td>Default: 0</td> <td>Normal</td> </tr> <tr> <td>1</td> <td>Reverse</td> </tr> </table>	Default: 0	Normal	1	Reverse
Default: 0	Normal				
1	Reverse				
<p>Web: Dual X.21 card DTE TT Invert</p> <p>UCI: tservd.@port[0].dte_tt_inv</p> <p>Opt: dte_tt_inv</p>	<p>Enables X.21 TT clock signal inversion.</p> <table border="1"> <tr> <td>Default: 0</td> <td>Normal</td> </tr> <tr> <td>1</td> <td>Invert</td> </tr> </table>	Default: 0	Normal	1	Invert
Default: 0	Normal				
1	Invert				
<p>Web: Dual X.21 card DCE TCLK</p> <p>Invert UCI: tservd.@port[0].dce_tclk_inv</p> <p>Opt: dce_tclk_inv</p>	<p>Enables X.21 DCE TCLK signal inversion.</p> <table border="1"> <tr> <td>Default: 0</td> <td>Normal</td> </tr> <tr> <td>1</td> <td>Invert</td> </tr> </table>	Default: 0	Normal	1	Invert
Default: 0	Normal				
1	Invert				
<p>Web: Dual X.21 card DCE RCLK Invert</p> <p>UCI: tservd.@port[0].dce_rclk_inv</p> <p>Opt: dce_rclk_inv</p>	<p>Enables X.21 DCE RCLK signal inversion.</p> <table border="1"> <tr> <td>Default: 0</td> <td>Normal</td> </tr> <tr> <td>1</td> <td>Invert</td> </tr> </table>	Default: 0	Normal	1	Invert
Default: 0	Normal				
1	Invert				
<p>Web: Dual X.21 card CLK Invert</p> <p>UCI: tservd.@port[0].x21_clk_invert</p> <p>Opt: x21_clk_invert</p>	<p>Enables X.21 DCE CLK signal inversion.</p> <table border="1"> <tr> <td>Default: 0</td> <td>Normal</td> </tr> <tr> <td>1</td> <td>Invert</td> </tr> </table>	Default: 0	Normal	1	Invert
Default: 0	Normal				
1	Invert				
<p>Web: Dual X.21 card RX data delay</p> <p>UCI: tservd.@port[0].x21_data_delay</p>	<p>Sets X.21 card RX data delay in number of bit positions.</p> <table border="1"> <tr> <td>Default</td> <td>0</td> </tr> <tr> <td>Range</td> <td>0-7</td> </tr> </table>	Default	0	Range	0-7
Default	0				
Range	0-7				

Opt: x21_data_delay									
Web: n/a UCI: tservd.@port[0].sync_tx_idle Opt: sync_tx_idle	<p>Defines the value of idle character (decimal) to transmit in case of transmit underrun. In HDLC mode, this configures inter-frame fill.</p> <table border="1"> <tr> <td>Default: 0</td> <td>Transmit 0 (in HDLC mode)</td> </tr> <tr> <td>126</td> <td>Transmit flags (in HDLC mode)</td> </tr> <tr> <td>255</td> <td>Transmit 1 (in HDLC mode)</td> </tr> <tr> <td>Range</td> <td>0-255</td> </tr> </table>	Default: 0	Transmit 0 (in HDLC mode)	126	Transmit flags (in HDLC mode)	255	Transmit 1 (in HDLC mode)	Range	0-255
Default: 0	Transmit 0 (in HDLC mode)								
126	Transmit flags (in HDLC mode)								
255	Transmit 1 (in HDLC mode)								
Range	0-255								
Web: n/a UCI: tservd.@port[0].v23_inband_carrier_signalling Opt: v23_inband_carrier_signalling	<p>Enables signalling of carrier by sending special characters</p> <table border="1"> <tr> <td>Default: 0</td> <td>Disabled</td> </tr> <tr> <td>1</td> <td>Enabled</td> </tr> </table>	Default: 0	Disabled	1	Enabled				
Default: 0	Disabled								
1	Enabled								
Web: n/a UCI: tservd.@port[0].v23_inband_carrier_on_char Opt: v23_inband_carrier_on_char	<p>Defines the character decimal to signal remote carrier on.</p> <table border="1"> <tr> <td>Default</td> <td>255</td> </tr> <tr> <td>Range</td> <td>0-255</td> </tr> </table>	Default	255	Range	0-255				
Default	255								
Range	0-255								
Web: n/a UCI: tservd.@port[0].v23_tx_gain Opt: v23_tx_gain	<p>Defines the transmit gain for v23 mode.</p> <table border="1"> <tr> <td>Default</td> <td>2</td> </tr> <tr> <td>Range</td> <td>0-255</td> </tr> </table>	Default	2	Range	0-255				
Default	2								
Range	0-255								
Web: n/a UCI: tservd.@port[0].v23_rx_loss Opt: v23_rx_loss	<p>Defines the receive loss for v23 mode.</p> <table border="1"> <tr> <td>Default: 1</td> <td>Receives samples divided by 1</td> </tr> </table>	Default: 1	Receives samples divided by 1						
Default: 1	Receives samples divided by 1								
Web: n/a UCI: tservd.@port[0].v23_rts_to_cts_delay Opt: v23_rts_to_cts_delay	<p>Defines the v23 modem RTS to CTS delay in milliseconds</p> <table border="1"> <tr> <td>Default</td> <td>20</td> </tr> </table>	Default	20						
Default	20								
Web: n/a UCI: tservd.@port[0].v23_is_four_wire Opt: v23_is_four_wire	<p>Defines the V23 modem LIM operation.</p> <table border="1"> <tr> <td>Default: 0</td> <td>2-wire</td> </tr> <tr> <td>1</td> <td>4-wire</td> </tr> </table>	Default: 0	2-wire	1	4-wire				
Default: 0	2-wire								
1	4-wire								
Web: n/a UCI: tservd.@port[0].v23_tx_timeout Opt: v23_tx_timeout	<p>Defines the V23 modem receive echo suppression timeout in milliseconds.</p> <table border="1"> <tr> <td>Default</td> <td>20</td> </tr> </table>	Default	20						
Default	20								
Web: n/a UCI: tservd.@port[0].v23_tx_rampdown Opt: v23_tx_rampdown	<p>Defines the time, in milliseconds, it takes the V23 transmitter to rampdown carrier from peak to zero.</p> <table border="1"> <tr> <td>Default</td> <td>30</td> </tr> </table>	Default	30						
Default	30								
Web: n/a UCI: tservd.@port[0].v23_tx_maxfill Opt: v23_tx_maxfill	<p>Defines the maximum transmit queue fill level in bytes.</p> <table border="1"> <tr> <td>Default</td> <td>127</td> </tr> <tr> <td>Range</td> <td>0-255</td> </tr> </table>	Default	127	Range	0-255				
Default	127								
Range	0-255								

Port Settings: Network Section

In this section you can configure the network side of the terminal server.



NOTE

The displayed settings vary depending on options selected.

PORT1

General

Serial

Network

Transport mode	TCP	Network transport protocol
Local IP	0.0.0.0	Local IP interface to use
TCP mode	Server	TCP mode
TCP listen port	855	TCP listening port
Remote IP 1	0.0.0.0	remote peer IP address (primary)
Remote IP 2	0.0.0.0	remote peer IP address (failover)
Enable TCP keepalives	<input checked="" type="checkbox"/>	enable TCP keepalives
TCP Keepalive interval	5	TCP Keepalive send interval (seconds)
TCP Keepalive timeout	2	TCP Keepalive timeout (seconds)
TCP Keepalive count	1	TCP Keepalive maximum probe count
TCP User timeout	20000	TCP close maximum wait ack time (milliseconds)
TCP nodelay	<input type="checkbox"/>	disable TCP Nagle algorithm
TCP always on	<input checked="" type="checkbox"/>	keep TCP always connected
Close TCP on DSR	<input type="checkbox"/>	close TCP session on detection of DSR signal low
Reconnect time (ms)	5000	time in milliseconds to start re-connecting after setting DTR low

The port settings network fields (TCP server mode)

Web Field/UCI/Package Option	Description				
Web: Transport Mode UCI: <code>tserverd.@port[0].udpMode</code> Opt: <code>udpMode</code>	Selects the transport mode. <table border="1"> <tr> <td>Default: 0</td> <td>TCP</td> </tr> <tr> <td>1</td> <td>UDP</td> </tr> </table>	Default: 0	TCP	1	UDP
Default: 0	TCP				
1	UDP				
Web: Local IP UCI: <code>tserverd.@port[0].local_ip</code> Opt: <code>local_ip</code>	Sets the local IP address to listen on. <table border="1"> <tr> <td>Default: 0.0.0.0</td> <td>Listen on any interface</td> </tr> <tr> <td>Range</td> <td>IPv4 address</td> </tr> </table>	Default: 0.0.0.0	Listen on any interface	Range	IPv4 address
Default: 0.0.0.0	Listen on any interface				
Range	IPv4 address				
Web: TCP Mode UCI: <code>tserverd.@port[0].server_mode</code> Opt: <code>server_mode</code>	Select between server and client modes of TCP. Only displayed if Transport Mode is TCP. <table border="1"> <tr> <td>Default: 1</td> <td>Server mode</td> </tr> <tr> <td>0</td> <td>Client mode</td> </tr> </table>	Default: 1	Server mode	0	Client mode
Default: 1	Server mode				
0	Client mode				
Web: TCP Listen Port UCI: <code>tserverd.@port[0].listen_port</code> Opt: <code>listen_port</code>	Sets the TCP listen port for server mode. Only displayed if transport mode is TCP and server mode is enabled. <table border="1"> <tr> <td>Default</td> <td>999</td> </tr> <tr> <td>Range</td> <td>1-65535</td> </tr> </table>	Default	999	Range	1-65535
Default	999				
Range	1-65535				
Web: Remote TCP Port 1 UCI: <code>tserverd.@port[0].ip_port1</code> Opt: <code>ip_port1</code>	Destination peer port IP 1 number. Only displayed if client mode is enabled. <table border="1"> <tr> <td>Default</td> <td>951</td> </tr> <tr> <td>Range</td> <td>1-65535</td> </tr> </table>	Default	951	Range	1-65535
Default	951				
Range	1-65535				
Web: Remote TCP Port 2 UCI: <code>tserverd.@port[0].ip_port2</code> Opt: <code>ip_port2</code>	Destination peer port IP 2 number for failover. Only displayed if client mode is enabled. <table border="1"> <tr> <td>Default</td> <td>951</td> </tr> <tr> <td>Range</td> <td>1-65535</td> </tr> </table>	Default	951	Range	1-65535
Default	951				
Range	1-65535				
Web: Remote IP 1 UCI: <code>tserverd.@port[0].remote_ip1</code> Opt: <code>remote_ip1</code>	Destination peer IP 1 address. <table border="1"> <tr> <td>Default</td> <td>0.0.0.0</td> </tr> <tr> <td>Range</td> <td>IPv4 address</td> </tr> </table>	Default	0.0.0.0	Range	IPv4 address
Default	0.0.0.0				
Range	IPv4 address				
Web: Remote IP 2 UCI: <code>tserverd.@port[0].remote_ip2</code> Opt: <code>remote_ip2</code>	Destination peer IP 2 address for failover. <table border="1"> <tr> <td>Default</td> <td>0.0.0.0</td> </tr> <tr> <td>Range</td> <td>IPv4 address</td> </tr> </table>	Default	0.0.0.0	Range	IPv4 address
Default	0.0.0.0				
Range	IPv4 address				
Web: Enable TCP Keepalives UCI: <code>tserverd.@port[0].tcp_keepalives_enabled</code> Opt: <code>tcp_keepalives_enabled</code>	Enables or disables TCP keepalives. Only displayed if transport mode is TCP. <table border="1"> <tr> <td>Default: 0</td> <td>Disabled</td> </tr> <tr> <td>1</td> <td>Enabled</td> </tr> </table>	Default: 0	Disabled	1	Enabled
Default: 0	Disabled				
1	Enabled				
Web: TCP Keepalive Interval UCI: <code>tserverd.@port[0].tcp_keepalive_interval</code> Opt: <code>tcp_keepalive_interval</code>	Interval in seconds between TCP keepalive probes. Only displayed if transport mode is TCP. <table border="1"> <tr> <td>Default</td> <td>5</td> </tr> <tr> <td>Range</td> <td>0-65535</td> </tr> </table>	Default	5	Range	0-65535
Default	5				
Range	0-65535				
Web: TCP Keepalive Timeout UCI: <code>tserverd.@port[0].tcp_keepalive_timeout</code> Opt: <code>tcp_keepalive_timeout</code>	Time in seconds to wait for response to a TCP keepalive probe. Only displayed if transport mode is TCP. <table border="1"> <tr> <td>Default</td> <td>2 seconds</td> </tr> <tr> <td>Range</td> <td>0-65535</td> </tr> </table>	Default	2 seconds	Range	0-65535
Default	2 seconds				
Range	0-65535				
Web: TCP Keepalive Count UCI: <code>tserverd.@port[0].tcp_keepalive_count</code>	Number of TCP keepalive probes to send before connection is closed. Only displayed if transport mode is TCP.				

Opt: tcp_keepalive_count	<table border="1"> <tr> <td>Default</td> <td>1</td> </tr> <tr> <td>Range</td> <td>0-65535</td> </tr> </table>	Default	1	Range	0-65535
Default	1				
Range	0-65535				
Web: TCP User Timeout UCI: tsvrd.@port[0].tcp_user_timeout Opt: tcp_user_timeout	Maximum time in milliseconds for TCP to wait for transmitted data to be 'acked' before closing connection in established state. Set to 0 to use kernel defaults. Only displayed if transport mode is TCP. <table border="1"> <tr> <td>Default: 20000</td> <td>20 seconds</td> </tr> <tr> <td>Range</td> <td>0-65535</td> </tr> </table>	Default: 20000	20 seconds	Range	0-65535
Default: 20000	20 seconds				
Range	0-65535				
Web: TCP Nodelay UCI: tsvrd.@port[0].tcp_nodelay Opt: tcp_nodelay	Sets TCP to delay behaviour. Only displayed if transport mode is TCP. <table border="1"> <tr> <td>Default: 0</td> <td>Normal operation</td> </tr> <tr> <td>1</td> <td>Disable TCP Nagle algorithm. Only display if transport mode is TCP.</td> </tr> </table>	Default: 0	Normal operation	1	Disable TCP Nagle algorithm. Only display if transport mode is TCP.
Default: 0	Normal operation				
1	Disable TCP Nagle algorithm. Only display if transport mode is TCP.				
Web: TCP Always on UCI: tsvrd.@port[0].tcp_always_on Opt: tcp_always_on	Keep TCP session always connected. Only displayed if transport mode is TCP and client mode is enabled.				
Web: Close TCP on DSR UCI: tsvrd.@port[0].close_tcp_on_dsr Opt: close_tcp_on_dsr	Close TCP session on detection of DSR signal low. Only displayed if Transport Mode is TCP and client mode is enabled. <table border="1"> <tr> <td>Default: 0</td> <td>Disabled. TCP connection/UDP session is initiated on detecting high state on the DSR interface signal.</td> </tr> <tr> <td>1</td> <td>Enabled. If it disconnects in the established state the TCP connection/UDP session is re-initiated.</td> </tr> </table>	Default: 0	Disabled. TCP connection/UDP session is initiated on detecting high state on the DSR interface signal.	1	Enabled. If it disconnects in the established state the TCP connection/UDP session is re-initiated.
Default: 0	Disabled. TCP connection/UDP session is initiated on detecting high state on the DSR interface signal.				
1	Enabled. If it disconnects in the established state the TCP connection/UDP session is re-initiated.				
Web: Reconnect Time (ms) UCI: tsvrd.@port[0].disc_time_ms Opt: disc_time_ms	Time in milliseconds to start reconnecting after setting DTR low. <table border="1"> <tr> <td>Default: 50000</td> <td>5 seconds</td> </tr> <tr> <td>Range</td> <td>0-10000</td> </tr> </table>	Default: 50000	5 seconds	Range	0-10000
Default: 50000	5 seconds				
Range	0-10000				
Web: UDP Keepalive Interval UCI: tsvrd.@port[0].udpKaIntervalMs Opt: udpKaIntervalMs	Defines time in milliseconds to send UDP keepalives (empty UDP packets) when no data to send. Only displayed if transport mode is UDP. <table border="1"> <tr> <td>Default: 0</td> <td>Disabled</td> </tr> <tr> <td>Range</td> <td>0-65535</td> </tr> </table>	Default: 0	Disabled	Range	0-65535
Default: 0	Disabled				
Range	0-65535				
Web: UDP Keepalive Count UCI: tsvrd.@port[0].udpKaCount Opt: udpKaCount	Defines the maximum number of remote UDP keepalives not received before UDP stream is considered broken. Only displayed if transport mode is UDP. <table border="1"> <tr> <td>Default</td> <td>3</td> </tr> <tr> <td>Range</td> <td>0-65535</td> </tr> </table>	Default	3	Range	0-65535
Default	3				
Range	0-65535				
Web: local UDP Port UCI: tsvrd.@port[0].udpLocalPort Opt: udpLocalPort	Local UDP port used by terminal server. Only displayed if transport mode is UDP. <table border="1"> <tr> <td>Default</td> <td>0</td> </tr> <tr> <td>Range</td> <td>0-65535</td> </tr> </table>	Default	0	Range	0-65535
Default	0				
Range	0-65535				
Web: remote UDP Port UCI: tsvrd.@port[0].udpRemotePort Opt: udpRemotePort	Remote UDP port used by terminal server. Only displayed if transport mode is UDP.				

41.2. Configuring Terminal Server Using UCI

```
root@VA_router:~# uci show tservd
tservd.main=tservd
tservd.main.log_severity=0
tservd.main.debug_rx_tx_enable=1
tservd.main.debug_ev_enable=1
tservd.@port[0]=port
tservd.@port[0].devName=/dev/ttySC0
tservd.@port[0].remote_ip1=0.0.0.0
tservd.@port[0].remote_ip2=0.0.0.0
```

Configuring Terminal Server using Package Options

```
root@VA_router:~# uci export tservd
package tservd
config tservd 'main'
option log_severity '0'
option debug_rx_tx_enable '1'
option debug_ev_enable '1'

config port
option devName '/dev/ttySC0'
option remote_ip1 '0.0.0.0'
option remote_ip2 '0.0.0.0'
```

41.3. Configuring Terminal Server DSR Signal Management Network

On the IP network side, the terminal server can operate in one of three modes:

- TCP Client
- TCP Server
- UDP

Based on the chosen network configuration, the DSR behaviour may vary.

DSR Signal Behaviour in TCP Client Mode

TCP Connection Management

Initial TCP connection initiation or next TCP connection initiation after disconnection is affected by configuration options `tcp_always_on` and `close_tcp_on_dsr`.

When option `tcp_always_on` is enabled terminal server keeps the TCP session always connected. If it disconnects in the established state, the TCP session is reinitiated.

If `tcp_always_on` is disabled TCP connection is initiated on detection of a high state on the DSP interface signal.

When option `close_tcp_on_dsr` is enabled terminal server detecting DSR down signal and closes the established TCP connection.

If option `close_tcp_on_dsr` is disabled then detecting DSR down does not affect the TCP connection.

TCP Connection Initiation at Startup

If you have set option `tcp_always_on1`, or DSR state is UP, the TCP connection setup is initiated immediately.

If you have set option `tcp_always_on0`, and DSR is DOWN, the terminal server waits for a DSR UP signal. When DSR UP is detected, the TCP connection is initiated.

TCP Connection Clearing

The TCP connection is cleared either by the network or by the terminal server application itself.

The TCP connection is cleared by the terminal server when it detects DSR interface signal DOWN and option `close_tcp_on_dsr` is 1.

TCP Connection Re-initiation

After TCP connection clearing, the terminal server takes action to re-setup the TCP connection after a hand off timeout.

If you have set option `tcp_always_on1`, or DSR state is UP, the TCP connection setup is initiated.

If you have set option `tcp_always_on0`, and DSR is DOWN, the terminal server waits for a DSR UP signal and then initiates a new TCP connection.

DSR Signal Behaviour in TCP Server Mode

TCP Connection Initiation at Startup

After a short startup delay, the terminal server starts listening for an incoming TCP connection from the remote peer.

TCP Connection Clearing

When in a TCP connection state, the TCP connection is cleared only by the network. Serial interface signals such as DSR do not cause TCP disconnection.

TCP Connection Re-initiation

When a TCP session goes down in the connected state, the terminal server immediately restarts listening for a new TCP connection from a remote peer.

DSR Signal Behaviour in UDP Mode

UDP Session Setup at Startup

If you have set option `tcp_always_on1`, or DSR state is UP, the UDP session is setup immediately on startup.

If you have set option `tcp_always_on0`, and DSR is DOWN, the terminal server waits for a DSR UP signal. When DSR UP is detected, the UDP session is setup.

UDP Session Clearing

A UDP session is normally never cleared, but if it is closed by the network sub-system, it gets re-setup after a hand off timeout.

A DSR signal DOWN event does not clear UDP session in the connected state.

UDP Session Reset

After UDP session clearing the terminal server takes action to reset up a UDP session after a hand off timeout.

If you have set option `tcp_always_on1`, or DSR state is UP, the UDP session is setup.

If you have set option `tcp_always_on0`, and DSR is DOWN, the terminal server waits for a DSR UP signal and then it resets up the UDP session.

41.4. Serial Mode GPIO Control

On some models of Merlin routers it is possible to change the physical transmission mode between RS232 and RS485. This is only applicable to the second serial port on the routers: `/dev/ttySC1`.

To enable `serial_mode_gpio_control` set the option to **1**.

Use the `portmode` option in addition to `serial_mode_gpio_control` to select between RS232, RS485 full duplex, RS485 half duplex, X.21 and V.23.

Checking the Current `serial_mode_gpio_control`

To check if terminal server is running, enter the following command:

```
root@VA_router:~# uci show tserverd | grep serial_mode_gpio_control
```

The output of the above command will look similar to the example below if `serial_mode_gpio_control` is enabled for the second serial port.

```
tserverd.port0.serial_mode_gpio_control=0  
tserverd.port1.serial_mode_gpio_control=1
```

41.5. Terminal Server Diagnostics

The `tserverd` process has to be running otherwise diagnostics options for terminal server will not be available.

Checking the Terminal Server Process

```
root@VA_router:~# -fl tserverd  
1264 root      1032 S tserverd
```

If Terminal Server is running it will be shown with its process ID.

Terminal Server Statistics

To view terminal server statistics, enter:

```
root@VA_router:~#tserf show stats
TERMINAL 1, Dev: /dev/ttySC0
State: LISTENING
Serial Bytes   Rx (0) Tx (0) TxErrs (0)
TCP Packets Rx(0) Tx (0) TxErrs (0)   TxBlocked (0)
TCP Bytes     Rx (0) Tx (0)
UDP Datagrams Rx (0) Tx (0) TxErrs (0)
UDP Bytes     Rx (0) Tx (0)
DSR   Up (0) Down (0)
```

Terminal Server Debug Statistics

To see debug statistics about terminal server, enter:

```
root@VA_router:~# tserf show debug all
TERMINAL 1, Dev: /dev/ttySC0
State: LISTENING
netRxBuf length=0 offset=0 hdrsz=0
ttyRxBuf length=0 offset=16 hdrsz=16
line_status_mask = 0x0 line_status = 0x0
RFC2217 negotiated=0
Tcp tx last error: 0
```

Terminal Server Serial Signals Debugging

To see terminal server serial signals statistics, enter:

```
root@VA_router:~# tserf show serial
TERMINAL-1, Dev: /dev/ttySC1
DSR=0 DTR=1 RTS=1 CTS=0 CAR=0 CD=0 RNG=0 LE=0 RI=0 ST=0 SR=0
TERMINAL-2, Dev: /dev/ttySC0
DSR=0 DTR=1 RTS=1 CTS=0 CAR=0 CD=0 RNG=0 LE=0 RI=0 ST=0 SR=0
```

Terminal Server Advanced Debugging

To view terminal server advanced debug commands for the terminal server, enter:

```
root@VA_router:~# tserv
=== Termserv diagnostics. Command syntax: ===
tserv show stats - show statistics
tserv clear stats - clear statistics
tserv show serial - show serial interface status
tserv send serial0 &lt;data>- send data to serial port 0
tserv start capture N, N=port number (0 to 3) - start capturing rx serial data
tserv print capture N, N=port number (0 to 3) - print captured rx serial data
tserv show serial txlog-hex <Port> [length], Port=port cfg index (0 to 3), length=length to show
tserv show serial rxlog-hex <Port> [length], Port=port cfg index (0 to 3), length=length to show
tserv show serial txlog-asc <Port> [length], Port=port cfg index (0 to 3), length=length to show
tserv show serial rxlog-asc <Port> [length], Port=port cfg index (0 to 3), length=length to show
tserv show debug - show debug info
tserv start userial rxlog - start USB serial card rx log
tserv quit - terminate termserv process
```

42. Configuring Terminal Package

Terminal package is used to automatically add entries to `getty` to `inittab` for extra incoming console/terminal connections.

Configuration Packages Used

Package	Sections
terminal	terminal

Terminal package is not available to configure using the web interface.

Web Field/UCI/Package Option	Description				
Web: n/a UCI: terminal.console.enabled Opt: enabled	Enables Terminal on the router. <table border="1"> <tr> <td>Default: 0</td> <td>Disabled</td> </tr> <tr> <td>1</td> <td>Enabled</td> </tr> </table>	Default: 0	Disabled	1	Enabled
Default: 0	Disabled				
1	Enabled				
Web: n/a UCI: terminal.console.device Opt: device	String value point at the tty device in /dev folder. <table border="1"> <tr> <td>Default</td> <td>None</td> </tr> <tr> <td><string></td> <td>Device name. (e.g. ttySC0 to use serial port 0)</td> </tr> </table>	Default	None	<string>	Device name. (e.g. ttySC0 to use serial port 0)
Default	None				
<string>	Device name. (e.g. ttySC0 to use serial port 0)				
Web: n/a UCI: terminal.console.speed Opt: speed	Set the speed of serial connection. <table border="1"> <tr> <td>Default</td> <td>115200</td> </tr> <tr> <td>Range</td> <td>Supported port speed</td> </tr> </table>	Default	115200	Range	Supported port speed
Default	115200				
Range	Supported port speed				
Web: n/a UCI: terminal.console.type Opt: type	String value represents supported terminal emulation mode. <table border="1"> <tr> <td>Default</td> <td>vt100</td> </tr> <tr> <td>string</td> <td>Supported terminal type.</td> </tr> </table>	Default	vt100	string	Supported terminal type.
Default	vt100				
string	Supported terminal type.				
Web: n/a UCI: terminal.console.flowcontrol Opt: flowcontrol	Enables hardware flow control RTS/CTS. <table border="1"> <tr> <td>Default: 0</td> <td>Disabled</td> </tr> <tr> <td>1</td> <td>Enabled</td> </tr> </table>	Default: 0	Disabled	1	Enabled
Default: 0	Disabled				
1	Enabled				

42.1. Configuring Terminal Package Using UCI

```
root@VA_router:~# uci show terminal
terminal.ttySC0=terminal
terminal.ttySC0.enabled=1
terminal.ttySC0.device=ttySC0
terminal.ttySC0.speed=115200
terminal.ttySC0.type=vt100
terminal.ttySC0.flowcontrol=1
```

Configuring Terminal using Package Options

```
root@VA_router:~# uci export terminal
package terminal
config terminal 'ttySC0'
option enabled '0'
option device 'ttySC0'
option speed '115200'
option type 'vt100'
option flowcontrol '1'
```

42.2. Terminal Diagnostics

Checking Terminal Entry in inittab

To check if terminal configuration is running, enter the following commands and confirm the line referring to the device name is present and looks similar to the last line below:

```
root@VA_router:~# cat /etc/inittab
::sysinit:/etc/init.d/rcS S boot
::shutdown:/etc/init.d/rcS K stop
ttyLTQ0::askfirst:getty -L 115200 ttyLTQ0 vt100
ttyLTQ1::askfirst:getty -L 115200 ttyLTQ1 vt100
ttySC0::respawn:getty -h -L 115200 ttySC0 vt100
```

43. Configuring RTUD

This chapter describes how to configure the RTUD feature on a Merlin router. RTU is only available on routers with a digital I/O interface.

You can edit parameters using:

- the text editor 'vi' or 'nano' after logging in using SSH;
- the router's web interface; or
- Activator.

Terminology

DI	Digital Input
DO	Digital Output
DNP3	Distributed Network Protocol version 3
I/O	Input/Output
IP	Internet Protocol
MQTT	Message Queuing Telemetry Transport
RTU	Remote Terminal Unit
RTUD	Remote Terminal Unit Daemon
SCADA	Supervisory Control and Data Acquisition
TCP	Transport Control Protocol
Where a configuration parameter has the value of 1 or 0	1 = Enabled 0 = Disabled
Where a configuration parameter has the value NULL	This means blank. Specify as " "

RTUD Overview

Merlin Series routers have an integrated digital IO block consisting of three digital inputs (DI) and 1 digital output (DO). The digital inputs are presented on the terminal block as a series of input contact terminals. The digital output is presented on the terminal block as a relay output contact.

The RTUD feature is implemented on the router by the RTUD daemon application. It allows the remote SCADA master to monitor and control the digital IOs of the router that acts as the RTU slave using several supported SCADA communication protocols:

- IEC 670-5-104 [1]
- DNP3 [2]
- Modbus TCP [3]
- MQTT

Configuration Package Used

Package	Sections
rtud	main

43.1. Configuring RTUD Using The Web Interface

To configure RTUD using the web interface, in the top menu browse to **SCADA -> RTUD**. The RTUD page appears.

There are five section tabs in the RTUD page:

Section	Description
General	Enables the SCADA RTU and selects the RTU protocol
IEC104	Configuration of IEC104 protocol options
DNP3	Configuration of DNP3 protocol options
ModbusTCP	Configuration of ModbusTCP protocol options
Advanced	Advanced debug configuration options

RTUD

Configuration of RTUD. RTUD is a SCADA application which acts as SCADA RTU, exposing the router's Digital Inputs and Output to SCADA Master. RTUD supports IEC 60870-5-104, DNP, Modbus TCP and MQTT Protocols

Main Settings

Delete

General
IEC104
DNP3
ModbusTCP
MQTT
Advanced

Enable Enable SCADA RTU outstation emulation

Auto generate configuration Enables automatic detection of GPIO present on board and auto generation of RTUD config

RTU Protocol MQTT Sets the RTU communication protocol

Local IP1 Local IP interface address 1 RTU binds to

Local IP2 Local IP interface address 2 RTU binds to

Synchronize time Enables RTU time synchronization to SCADA Master time

Short Pulse (ms) Short pulse duration (milliseconds)

Long Pulse (ms) Long pulse duration (milliseconds)

Execute Timeout (secs) Maximum time in seconds allowed between Select and Execute

The RTUD main settings page

43.1.1. Configuring RTUD General Options

RTUD

Configuration of RTUD. RTUD is a SCADA application which acts as SCADA RTU, exposing the router's Digital Inputs and Output to SCADA Master. RTUD supports IEC 60870-5-104, DNP, Modbus TCP and MQTT Protocols

Main Settings

[Delete](#)

General **IEC104** DNP3 ModbusTCP MQTT Advanced

Enable [Enable SCADA RTU outstation emulation](#)

Auto generate configuration [Enables automatic detection of GPIO present on board and auto generation of RTUD config](#)

RTU Protocol **MQTT** [Sets the RTU communication protocol](#)

Local IP1 [Local IP interface address 1 RTU binds to](#)

Local IP2 [Local IP interface address 2 RTU binds to](#)

Synchronize time [Enables RTU time synchronization to SCADA Master time](#)

Short Pulse (ms) [Short pulse duration \(milliseconds\)](#)

Long Pulse (ms) [Long pulse duration \(milliseconds\)](#)

Execute Timeout (secs) [Maximum time in seconds allowed between Select and Execute](#)

The RTUD main settings page showing the general settings tab

Web Field/UCI/Package Option	Description						
Web: Enabled UCI: rtud.main.enabled Opt: enabled	Enables or disables RTUD application. <table border="1"> <tr> <td>Default: 0</td> <td>Disabled</td> </tr> <tr> <td>1</td> <td>Enabled</td> </tr> </table>	Default: 0	Disabled	1	Enabled		
Default: 0	Disabled						
1	Enabled						
Web: RTU Protocol UCI: rtud.main.protocol Opt: protocol	Sets the RTU communication protocol. <table border="1"> <tr> <td>Default: iec104</td> <td>IEC 60870-5-104</td> </tr> <tr> <td>mbtcp</td> <td>Modbus TCP</td> </tr> <tr> <td>dnp3</td> <td>Distributed Network Protocol V3 (over TCP)</td> </tr> </table>	Default: iec104	IEC 60870-5-104	mbtcp	Modbus TCP	dnp3	Distributed Network Protocol V3 (over TCP)
Default: iec104	IEC 60870-5-104						
mbtcp	Modbus TCP						
dnp3	Distributed Network Protocol V3 (over TCP)						
Web: Local IP UCI: rtud.main.local_ip Opt: local_ip	Defines the local IP interface address the RTU binds to. <table border="1"> <tr> <td>Default</td> <td>0.0.0.0</td> </tr> <tr> <td>Range</td> <td>A valid IPv4 or IPv6 address.</td> </tr> </table>	Default	0.0.0.0	Range	A valid IPv4 or IPv6 address.		
Default	0.0.0.0						
Range	A valid IPv4 or IPv6 address.						
Web: Synchronize Time UCI: rtud.main.sync_time Opt: sync_time	Enables RTU time synchronisation to master time. If enabled, the router will set its clock as the corresponding commands from the master station in each communication protocol. <table border="1"> <tr> <td>Default: 0</td> <td>Disabled</td> </tr> <tr> <td>1</td> <td>Enabled</td> </tr> </table>	Default: 0	Disabled	1	Enabled		
Default: 0	Disabled						
1	Enabled						
Web: Short Pulse UCI: rtud.main.short_pulse Opt: short_pulse	Short pulse duration in milliseconds, currently used in IEC104 protocol in processing digital output setting command, if the master specifies its use. <table border="1"> <tr> <td>Default</td> <td>50</td> </tr> <tr> <td>Range</td> <td>10-1000</td> </tr> </table>	Default	50	Range	10-1000		
Default	50						
Range	10-1000						
Web: Long Pulse UCI: rtud.main.long_pulse Opt: long_pulse	Long pulse duration in milliseconds, currently used in IEC104 protocol in processing digital output setting command, if the master specifies its use. <table border="1"> <tr> <td>Default: 0</td> <td>1000</td> </tr> <tr> <td>Range</td> <td>10-1000</td> </tr> </table>	Default: 0	1000	Range	10-1000		
Default: 0	1000						
Range	10-1000						

43.1.2. Configure RTUD Advanced Options

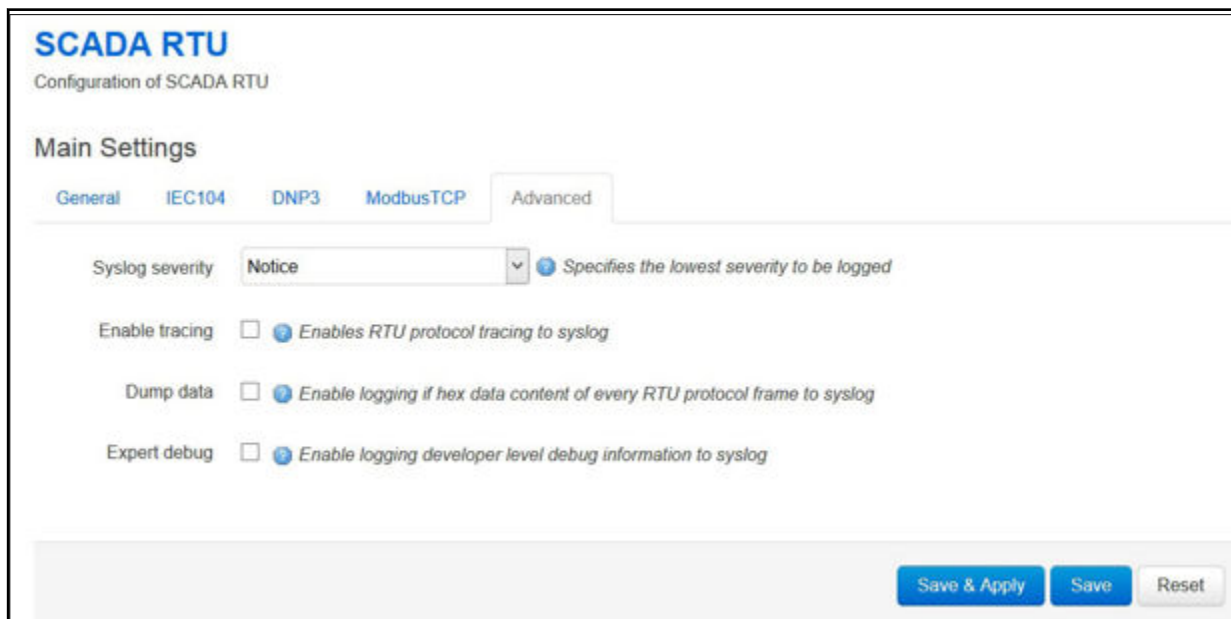

The RTUD advanced settings page

Figure 7.

Web Field/UCI/Package Option	Description																
Web: Log level UCI: rtud.main.loglevel Opt: loglevel	Determines the syslog level. Events up to this priority will be logged. Default is 5 - Notice. <table border="1"> <tr><td>0</td><td>Emergency</td></tr> <tr><td>1</td><td>Alert</td></tr> <tr><td>2</td><td>Critical</td></tr> <tr><td>3</td><td>Error</td></tr> <tr><td>4</td><td>Warning</td></tr> <tr><td>5</td><td>Notice</td></tr> <tr><td>6</td><td>Informational</td></tr> <tr><td>7</td><td>Debug</td></tr> </table>	0	Emergency	1	Alert	2	Critical	3	Error	4	Warning	5	Notice	6	Informational	7	Debug
0	Emergency																
1	Alert																
2	Critical																
3	Error																
4	Warning																
5	Notice																
6	Informational																
7	Debug																
Web: Trace UCI: rtud.main.trace_on Opt: trace_on	Enables protocol tracing to syslog. <table border="1"> <tr><td>Default: 0</td><td>Disabled</td></tr> <tr><td>1</td><td>Enabled</td></tr> </table>	Default: 0	Disabled	1	Enabled												
Default: 0	Disabled																
1	Enabled																
Web: Dump data UCI: rtud.main.dump_data Opt: dump_data	Enables logging the context of protocol frames in ASCII hex format to syslog. <table border="1"> <tr><td>Default: 0</td><td>Disabled</td></tr> <tr><td>1</td><td>Enabled</td></tr> </table>	Default: 0	Disabled	1	Enabled												
Default: 0	Disabled																
1	Enabled																
Web: Expert debug UCI: rtud.main.expert_debug Opt: expert_debug	Enables highest level of debug logging. For Westermo engineering use only.																

43.1.3. Configuring RTUD IEC104 Options

Main Settings Delete

General IEC104 DNP3 ModbusTCP Advanced

IEC104 Listening TCP Port Local TCP port IEC104 RTU listens on

IEC104 K IEC104 Maximum number of outstanding I frames

IEC104 T2 IEC104 Timeout for sending S frames in case of no data (milliseconds)

IEC104 ASDU Common Address ASDU address of the IEC104 RTU

IEC104 COT Source Octet Most significant octet in the cause of transmission field

IEC104 DI Type ID Specifies IEC104 type ID to use when sending Digital Inputs

Digital Input 0 IOA IEC104 Information Object Address of INPUT 0

Digital Input 1 IOA IEC104 Information Object Address of INPUT 1

Web Field/UCI/Package Option	Description															
Web: IEC104 Listening TCP Port UCI: rtud.main.iec104_listen_tcpport Opt: iec104_listen_tcpport	Local TCP port IEC104 RTC listens on. <table border="1"> <tr> <td>Default</td> <td>2404</td> </tr> <tr> <td>Range</td> <td>1-65535</td> </tr> </table>	Default	2404	Range	1-65535											
Default	2404															
Range	1-65535															
Web: IEC104 K UCI: rtud.main.iec104_k Opt: iec104_k	IEC parameter K. Maximum number of outstanding frames. <table border="1"> <tr> <td>Default</td> <td>12</td> </tr> <tr> <td>Range</td> <td>1-3267</td> </tr> </table>	Default	12	Range	1-3267											
Default	12															
Range	1-3267															
Web: IEC104 T2 UCI: rtud.main.iec104_t2 Opt: iec104_t2	IEC 104 parameter T2. Timeout for sending, in milliseconds, S frames in case of no data. <table border="1"> <tr> <td>Default</td> <td>1000</td> </tr> <tr> <td>Range</td> <td>1-6000</td> </tr> </table>	Default	1000	Range	1-6000											
Default	1000															
Range	1-6000															
Web: IEC104 ASDU Common Address UCI: rtud.main.iec104_asdu_addr Opt: iec104_asdu_addr	IEC 104 parameter CA (also known as CASDU). ASDU common address of the RTU. <table border="1"> <tr> <td>Default</td> <td>0</td> </tr> <tr> <td>Range</td> <td>1-65535</td> </tr> </table>	Default	0	Range	1-65535											
Default	0															
Range	1-65535															
Web: IEC104 COT Source Octet UCI: rtud.main.iec104_cot_source_octet Opt: iec104_cot_source_octet	IEC104 parameter COT value. The value of the most significant octet in the 'cause of transmission' header field. <table border="1"> <tr> <td>Default</td> <td>1</td> </tr> <tr> <td>Range</td> <td>0-255</td> </tr> </table>	Default	1	Range	0-255											
Default	1															
Range	0-255															
Web: IEC104 DI Type ID UCI: rtud.main.iec104_type_id Opt: iec104_type_id	Defines the IEC104 Type ID for digital inputs <table border="1"> <thead> <tr> <th>Option</th> <th>Description</th> <th>UCI</th> </tr> </thead> <tbody> <tr> <td>SPI</td> <td>Single point</td> <td>1</td> </tr> <tr> <td>DPI (double point</td> <td>Double point</td> <td>3</td> </tr> <tr> <td>SPI</td> <td>Single point with time</td> <td>30</td> </tr> <tr> <td>DPI</td> <td>Double point with time</td> <td>31</td> </tr> </tbody> </table>	Option	Description	UCI	SPI	Single point	1	DPI (double point	Double point	3	SPI	Single point with time	30	DPI	Double point with time	31
Option	Description	UCI														
SPI	Single point	1														
DPI (double point	Double point	3														
SPI	Single point with time	30														
DPI	Double point with time	31														
Web: Digital Input 0 IOA UCI: rtud.main.dg_input0_ioaddr Opt: dg_input0_ioaddr	IEC104 Information Object Address (IOA) of Digital Input 0. <table border="1"> <tr> <td>Default</td> <td>1</td> </tr> <tr> <td>Range</td> <td>1-1677712</td> </tr> </table>	Default	1	Range	1-1677712											
Default	1															
Range	1-1677712															
Web: Digital Input 1 IOA UCI: rtud.main.dg_input1_ioaddr Opt: dg_input1_ioaddr	IEC104 Information Object Address (IOA) of Digital Input 1. <table border="1"> <tr> <td>Default</td> <td>2</td> </tr> <tr> <td>Range</td> <td>1-1677712</td> </tr> </table>	Default	2	Range	1-1677712											
Default	2															
Range	1-1677712															
Web: Digital Input 0 IOA UCI: rtud.main.dg_output0_ioaddr Opt: dg_output0_ioaddr	IEC104 Information Object Address (IOA) of Digital Input 0. <table border="1"> <tr> <td>Default</td> <td>3</td> </tr> <tr> <td>Range</td> <td>1-1677712</td> </tr> </table>	Default	3	Range	1-1677712											
Default	3															
Range	1-1677712															

43.1.4. Configure RTUD DNP3 Options

Status ▾
System ▾
Services ▾
Network ▾
Logout

SCADA RTU

Configuration of SCADA RTU

Main Settings

General
IEC104
DNP3
ModbusTCP
Advanced

DNP3 Listening TCP Port [?](#) Local TCP port DNP3 RTU listens on

DNP3 Source Address [?](#) Local (RTU) DNP3 address

DNP3 Remote Address [?](#) Remote (Master) DNP3 address

Save & Apply
Save
Reset

Web Field/UCI/Package Option	Description				
Web: DNP3 Listening TCP Port UCI: rtud.main.dnp3_listen_tcpport Opt: dnp3_listen_tcpport	Sets the local TCP port the DNP3 RTU listens on. <table border="1" style="margin-left: 20px;"> <tr><td>Default</td><td>2000</td></tr> <tr><td>Range</td><td>1-65535</td></tr> </table>	Default	2000	Range	1-65535
Default	2000				
Range	1-65535				
Web: DNP3 Source Address UCI: rtud.main.dnp3_dl_srcaddr Opt: dnp3_dl_srcaddr	Sets the local (RTU) DNP3 address. <table border="1" style="margin-left: 20px;"> <tr><td>Default</td><td>0</td></tr> <tr><td>Range</td><td>0-65535</td></tr> </table>	Default	0	Range	0-65535
Default	0				
Range	0-65535				
Web: DNP3 Remote Address UCI: rtud.main.dnp3_dl_dstadr Opt: dnp3_dl_dstadr	Sets the remote (Master) DNP3 address <table border="1" style="margin-left: 20px;"> <tr><td>Default</td><td>1</td></tr> <tr><td>Range</td><td>0-255</td></tr> </table>	Default	1	Range	0-255
Default	1				
Range	0-255				

43.1.5. Configure RTUD Modbus Options

Web Field/UCI/Package Option	Description				
Web: Modbus TCP Slave Address UCI: rtud.main.mbtcp_devaddr Opt: mbtcp_devaddr	Sets the Modbus slave address. <table border="1"> <tr><td>Default</td><td>0</td></tr> <tr><td>Range</td><td>1-247</td></tr> </table>	Default	0	Range	1-247
Default	0				
Range	1-247				
Web: Modbus TCP Listening Port UCI: rtud.main.mbtcp_listen_tcpport Opt: mbtcp_listen_tcpport	Sets the local TCP port Modbus RTU listens on. <table border="1"> <tr><td>Default</td><td>0</td></tr> <tr><td>Range</td><td>1-65535</td></tr> </table>	Default	0	Range	1-65535
Default	0				
Range	1-65535				
Web: Modbus Discreet Inputs Start Address UCI: rtud.main.mbtcp_di_start_addr Opt: mbtcp_di_start_addr	Sets the Modbus Discreet Inputs start address. This is the address of the first digital input in the modbus data model. Note: address of inputs and outputs are allowed to overlap, that is, may be the same. <table border="1"> <tr><td>Default</td><td>0</td></tr> <tr><td>Range</td><td>0-65535</td></tr> </table>	Default	0	Range	0-65535
Default	0				
Range	0-65535				
Web: Modbus Coils Start Address UCI: rtud.main.mbtcp_co_start_addr Opt: mbtcp_co_start_addr	Sets the Modbus Coils Start address. This is the address of the first digital output in the modbus data model. Note: address of inputs and outputs are allowed to overlap, that is, may be the same. <table border="1"> <tr><td>Default</td><td>0</td></tr> <tr><td>Range</td><td>0-65535</td></tr> </table>	Default	0	Range	0-65535
Default	0				
Range	0-65535				

43.2. Controlling The RTUD Application Manually Using The Web Interface

When you have enabled RTUD, the application starts automatically. If necessary, you can control the application manually.

Browse to the top menu and select **System -> Startup**.

Status ▾ System ▾ Services ▾ Network ▾ Logout					
50	ripd				
50	rtud				
50	slad				
50	snmpd				
50	strongswan				
50	telnet				
50	tservd				
50	uhttpd				
50	vald				
50	vnstat				

The startup page

Find the RTUD entry and click either **Enabled/Disabled**, **Start**, **Restart**, or **Stop**, depending on which option you require.

To check if the application is running, select **Status -> Processes**. The Processes page appears.

Status ▾ System ▾ Services ▾ Network ▾ Logout							
2557	root	/usr/sbin/crond -c /etc/crontabs -l 5	0%	3%			
2666	root	/usr/sbin/dropbear -P /var/run/dropbear.1.pid -p 22 -b /etc/banner	0%	2%			
2900	root	/usr/sbin/rtud	0%	2%			
2955	root	/usr/sbin/snmpd -Lsd0-6 -p /var/run/snmpd.pid -m -c /var/conf/snmpd.conf	0%	7%			
3003	root	/usr/lib/ipsec/starter	0%	2%			
3005	root	/usr/lib/ipsec/charon --use-syslog	0%	51%			
3147	root	/usr/sbin/uhttpd_mon	0%	2%			
3587	root	[kworker/0:0]	0%	0%			
3841	root	0% /usr/sbin/uhttpd -f -h /www -r VirtualAccess -c /etc/http.conf -x /cgi-bin -t 60 -T 30 -R -p 0 0 0 0 80 -C /etc/uhttpd.crt -K /etc/uhttpd.key -s 0 0 0 0 443 -l /cgi-bin/luci -L /usr/lib/uhttpd.lua	8%	5076			
3842	root	0% sh -c top -bn1	3%	1780			
3843	root	31% top -bn1	3%	1780			

The status process page

43.3. Configuring RTUD Using Command Line

The RTUD configuration is stored in `/etc/config/rtud`

You must restart the RTUD application for your option changes to take effect. The default content of the RTUD configuration file is shown below.

RTUD using UCI

```
root@VA_router:~# uci show rtud
rtud.main=rtud
rtud.main.enable=1
# set to 1 to enable RTUD daemon
rtud.main.protocol=iec104
rtud.main.local_ip=0.0.0.0
rtud.main.sync_time=0
rtud.main.short_pulse=50
rtud.main.long_pulse1000
rtud.main.loglevel=5
rtud.main.trace_on=0
rtud.main.dump_data=0

rtud.main.iec104_listen_tcpport=2404
rtud.main.iec104_k=12
rtud.main.iec104_t2=10000
rtud.main.iec104_asdu_addr=0
rtud.main.iec104_cot_source_octet=1

rtud.main.dg_input0_ioaddr=1
rtud.main.dg_input1_ioaddr=2
rtud.main.dg_output0_ioaddr=3

rtud.main.dnp3_listen_tcpport=20000
rtud.main.dnp3_dl_srcaddr=0
rtud.main.dnp3_dl_dstaddr=0

rtud.main.mbtcp_devaddr=0
rtud.main.mbtcp_listen_port=502
rtud.main.mbtcp_di_start_addr=0
rtud.main.mbtcp_co_start_addr=0
```

RTUD using Package Options

```
root@VA_router:~# uci export rtud
package rtud
config rtud main
# set to 1 to enable RTUD daemon
option enable 0
option protocol 'iec104'
option local_ip '0.0.0.0'
option sync_time 0
option short_pulse 50
option long_pulse 1000
option loglevel 5
option trace_on 0
option dump_data 0
option expert_debug 0
option iec104_listen_tcpport 2404
option iec104_k 12
option iec104_t2 10000
option iec104_asdu_addr 0
option iec104_cot_source_octet 1

option dg_input0_ioaddr 1
option dg_input1_ioaddr 2
option dg_output0_ioaddr 3

option dnp3_listen_tcpport 20000
option dnp3_dl_srcaddr 0
option dnp3_dl_dstaddr 0

option mbtcp_devaddr 0
option mbtcp_listen_port 502
option mbtcp_di_start_addr 0
option mbtcp_co_start_addr 0
```

43.4. RTUD Diagnostics

Viewing RTUD Statistics using the Web Interface

To view the RTUD point list, session status and counters, from the top menu, select **Status -> RTUD**.

Status ▾
System ▾
Services ▾
Network ▾
Logout

SCADA RTU Points

IO Name	IO Type	IO Address	IO Value
dg_input0	Input	IOA1	0
dg_input1	Input	IOA2	0
dg_output0	Output	IOA3	0

SCADA RTU Statistics

Protocol	State	Link Rx/Tx/Errs	App Rx/Tx/Errs
IEC104	LISTENING	0 / 0 / 0	0 / 0 / 0

The RTUD points and stats page

RTUD Diagnostic Options

To view RTUD diagnostic options, enter:

```

root@VA_router:~# rtu
=== RTU daemon diagnostics. Command syntax: ===
rtu set loglevel <level>; (0 to 7)
rtu show config - show config
rtu show stats - show stats
rtu clear stats - clear stats
rtu show points - show RTU IO points
rtu show dnp3 - show DNP3 stats
rtu show modbus - show Modbus stats
rtu set point <IO name>; <value>; set output IO point valu

```

44. SCADA IEC 104 Gateway

Supervisory control and data acquisition (SCADA) systems are used by industrial organisations and companies to control and monitor physical processes, examples of which are electricity transmission, gas and oil transportation in pipelines, water distribution and traffic lights control. Alarm handling is usually an important part of most SCADA implementations.

SCADA systems usually consist of:

- Supervisory computers
- Remote terminal units (RTUs)
- Programmable logic controllers (PLCs)

The IEC 104 gateway feature on the router is used for SCADA protocol conversion where the SCADA master is running IEC 104 protocol:

- IEC 104 to IEC 101 conversion (balanced and unbalanced)
- IEC 104 to DNP3
- IEC 104 to MODBUS (serial to TCP)
- IEC 612850 to IEC 101 unbalanced conversion

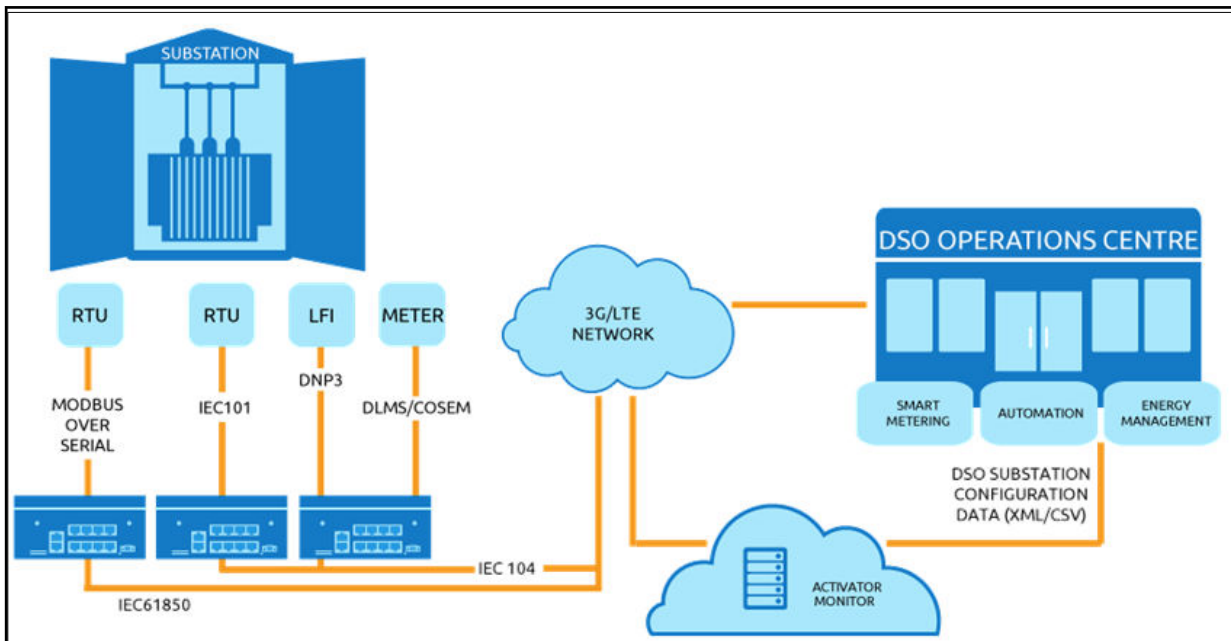

Example network for IEC 104 to RTU protocol conversion

Configuration for the above conversions is done in two parts:

- IEC 104 gateway (iecd package), and
- Terminal server (tservd package)

The IEC 104 gateway handles the protocol processing while the terminal server handles low level serial communication.



NOTE

The terminal server is not required for IEC 104 to Modbus TCP.

Configuration Packages Used

Package	Sections
iecd	main
	port
	point
tservd	main
	port

44.1. IEC 104 Gateway Configuration Using The Web Interface

In the top menu, select **Services -> IEC104 Gateway**. The IEC 104 gateway page appears.

IEC104 Gateway

Configuration of IECD (IEC104 Gateway)

Main Settings

Enable [Enable IEC104 Gateway](#)

Port Settings

This section contains no values yet

IEC101 Links

Port number	IEC101 Link Address	IEC101 Link ASDU Addr
<i>(1..4) Serial port</i>	<i>Link address of the IEC101 station</i>	<i>ASDU address of the IEC101 station</i>

This section contains no values yet

Points

The IEC 104 gateway configuration page

There are four sections in the IEC 104 Gateway page:

Section	Description
Main Settings	Enables the IEC 104 gateway.
Port Settings	Sets the IEC 104 SCADA master communication settings and the protocol methods used by the RTUs: <ul style="list-style-type: none"> • IEC 101 unbalanced or balanced • DNP3 • Modbus over serial • Modbus over TCP
IEC101 Links	Defines the IEC 101 slave links used in IEC 101 conversion. Each link is defined by a <code>config iec101link</code> section block. There is a maximum of 32 links supported. In IEC 101 unbalanced mode all of these links can be used. In IEC 101 balanced mode only one outstation per serial port is assumed since these will be point to point links.
Points	Configures the data point mappings. Note: there are no data point mappings in IEC104 to IEC101 conversion.

44.1.1. Main Settings

IEC104 Gateway

Configuration of IECD (IEC104 Gateway)

Main Settings

Enable ? Enable IEC104 Gateway

The IEC 104 gateway main settings configuration page

Web Field/UCI/Package Option	Description				
Web: Enable	Enables IEC104 gateway.				
UCI: iecd.main.enable	<table border="1" style="width: 100%;"> <tr> <td>Default: 0</td> <td>Disabled</td> </tr> <tr> <td>1</td> <td>Enabled</td> </tr> </table>	Default: 0	Disabled	1	Enabled
Default: 0	Disabled				
1	Enabled				
Opt: enable					

44.1.2. Port Settings

The port configuration will depend on the desired protocol conversion. There are 5 sections.

Section	Description
General	Enables an IEC104 port and selects the RTU protocol method.
IEC104	Defines the IEC104 gateway configuration for communication with the SCADA Master.
IEC101	Defines the IEC104 to IEC101 conversion parameters.
DNP3	Defines the IEC104 to DNP3 conversion parameters.
Modbus	Defines the IEC104 to MODBUS conversion parameters (Modbus over serial or Modbus over TCP).
Advanced	Defines logging and TCP keepalive options for all conversion methods.

In the Port Settings section, enter a text name that will be used for the iecd port section, for example, Port1. Select **Add**. The IECD port configuration options appear.

44.1.3. Port Settings: General

In this section you can configure general port settings. Check **Enable** to enable the port and select the appropriate RTU protocol from the Slave Protocol and Master Protocol drop-down menus.

Port Settings

PORT1

General IEC104 IEC101 DNP3 Modbus Advanced

Enable Enables IEC104 Gateway port

Slave Protocol IEC104 Sets protocol method used by SCADA master to connect to this router (acting as a slave)

Master Protocol IEC101 Sets protocol method used by this router (acting as a master) to connect to outstations

The IEC 104 gateway port settings: general configuration page

Web Field/UCI/Package Option	Description
Web: Enable UCI: iecd.<port>.enable Opt: enable	Enables an IEC104 port.
Web: Slave Protocol UCI: iecd.<port>.slave_protocol Opt: slave_protocol	Defines the protocol method used by the SCADA master to connect to this router (acting as slave).
Web: Master Protocol UCI: iecd.<port>.master_protocol Opt: master_protocol	Defines the protocol method used by this router (acting as a master) to connect to the outstations.
Web: n/a UCI: iecd.<port>.pointmap_file Opt: pointmap_file	Defines the path to the points map file, for example: <code>/root/iecd/iecd_points1.csv</code>

44.1.4. Port Settings: IEC 104

In this section you can configure IEC104 settings.

PORT1

General IEC104 IEC101 DNP3 Modbus Advanced

IEC104 Track RTU DL 0=Keep IEC104 Always Up; 1=IEC104 UP only while RTU data link up

IEC104 IOA Offset Value to add to each Information Object Address of each configured point

IEC104 Local IP Local IP address this IEC104 peer binds to

IEC104 Listening TCP Port Local TCP port this IEC104 peer listens on

IEC61850 Local IP Local IP address this IEC61850 peer binds to

IEC61850 Listening TCP Port Local TCP port this IEC61850 peer listens on

IEC104 K Maximum number of outstanding I frames

IEC104 W Receiver acknowledges sender frames after at most W frames (Recommended 2/3 of K)

IEC104 T2 Timeout for sending S frames in case of no data (milliseconds)

Enable IEC104 time synchronization Enables synchronization of router time to IEC104 master time

Transfer comms status in NT bit Enables transfer of RTU comms status in IEC104 Not Topical bit with each data point

IEC104 CASDU Common ASDU address

Send EOI Enables sending of IEC104 End Of Initialization message to Master

Enable IEC 62351-5 secure mode Enables IEC 62351-5 security

The IEC 104 gateway port IEC 104 configuration page

Web Field/UCI/Package Option	Description						
Web: IEC104 Track RTU DL UCI: iecd.<port>.iec104_track_rtu_dl Opt: iec104_track_rtu_dl	Defines whether the IEC 104 link follows the state of the RTU data link. <table border="1"> <tr> <td>Default: 0</td> <td>Always listens and accepts connection from the IEC 104 master. This means IEC 104 is always up independently of the RTU protocol.</td> </tr> <tr> <td>1</td> <td>IEC 104 is up only while RTU data link is up. The IEC 104 socket is closed and IEC 104 will only start listening when RTU data link is up.</td> </tr> </table>	Default: 0	Always listens and accepts connection from the IEC 104 master. This means IEC 104 is always up independently of the RTU protocol.	1	IEC 104 is up only while RTU data link is up. The IEC 104 socket is closed and IEC 104 will only start listening when RTU data link is up.		
Default: 0	Always listens and accepts connection from the IEC 104 master. This means IEC 104 is always up independently of the RTU protocol.						
1	IEC 104 is up only while RTU data link is up. The IEC 104 socket is closed and IEC 104 will only start listening when RTU data link is up.						
Web: IEC104 IOA Offset UCI: iecd.<port>.ioa_offset Opt: ioa_offset	Defines the value to add to each Information Object Address of each configured point. <table border="1"> <tr> <td>Default</td> <td>0</td> </tr> </table>	Default	0				
Default	0						
Web: IEC104 Local IP UCI: iecd.<port>.iec104_local_ip Opt: iec104_local_ip	Defines the local IP address this IEC 104 peer binds to. <table border="1"> <tr> <td>Default</td> <td>0.0.0.0</td> </tr> <tr> <td></td> <td>Blind to outgoing port.</td> </tr> </table>	Default	0.0.0.0		Blind to outgoing port.		
Default	0.0.0.0						
	Blind to outgoing port.						
Web: IEC104 Listening TCP Port UCI: iecd.<port>.iec104_local_tcpport Opt: iec104_local_tcpport	Defines the local TCP port this IEC 104 peer listens on. <table border="1"> <tr> <td>Default</td> <td>2404</td> </tr> <tr> <td>Range</td> <td>1-65535</td> </tr> </table>	Default	2404	Range	1-65535		
Default	2404						
Range	1-65535						
Web: IEC61850 Local IP UCI: iecd.<port>.iec61850_local_ip Opt: iec61850_local_ip	Defines the local IP address this IEC 61850 peer binds to. <table border="1"> <tr> <td>Default</td> <td>0.0.0.0</td> </tr> <tr> <td></td> <td>Blind to outgoing port.</td> </tr> <tr> <td>Range</td> <td></td> </tr> </table>	Default	0.0.0.0		Blind to outgoing port.	Range	
Default	0.0.0.0						
	Blind to outgoing port.						
Range							
Web: IEC61850 Listening TCP Port UCI: iecd.<port>.iec61850_local_tcpport Opt: iec61850_local_tcpport	Defines the local TCP port this IEC 61850 peer listens on. <table border="1"> <tr> <td>Default</td> <td>102</td> </tr> <tr> <td>Range</td> <td>1-65535</td> </tr> </table>	Default	102	Range	1-65535		
Default	102						
Range	1-65535						
Web: IEC104 K UCI: iecd.<port>.iec104_k Opt: iec104_k	Defines the maximum number of outstanding I frames. <table border="1"> <tr> <td>Default</td> <td>12</td> </tr> <tr> <td>Range</td> <td></td> </tr> </table>	Default	12	Range			
Default	12						
Range							
Web: IEC104 W UCI: iecd.<port>.iec104_w Opt: iec104_w	Defines the number of frames after which the receiver will acknowledge. It is recommended that this value is 2/3 the value of IEC 104K. <table border="1"> <tr> <td>Default</td> <td>9</td> </tr> <tr> <td>Range</td> <td></td> </tr> </table>	Default	9	Range			
Default	9						
Range							
Web: IEC104 T2 UCI: iecd.<port>.iec104_t2 Opt: iec104_t2	Defines the timeout in milliseconds for sending S frames in case of no data. <table border="1"> <tr> <td>Default</td> <td>10000 milliseconds.</td> </tr> <tr> <td>Range</td> <td></td> </tr> </table>	Default	10000 milliseconds.	Range			
Default	10000 milliseconds.						
Range							
Web: Enable IEC104 time synchronization UCI: iecd.<port>.iec104_sync_time Opt: iec104_sync_time	Enables synchronisation of router time to IEC 104 master time. <table border="1"> <tr> <td>Default: 1</td> <td>Enable synchronisation.</td> </tr> <tr> <td>0</td> <td>Disable synchronisation.</td> </tr> </table>	Default: 1	Enable synchronisation.	0	Disable synchronisation.		
Default: 1	Enable synchronisation.						
0	Disable synchronisation.						
Web: Transfer comms status in NT bit UCI: iecd.<port>.iec104_comms_status_nt Opt: iec104_comms_status_nt	Enables transfer of RTU comms status in IEC 104 Not Topical bit with each data point. <table border="1"> <tr> <td>Default</td> <td></td> </tr> <tr> <td>1</td> <td></td> </tr> </table>	Default		1			
Default							
1							
Web: IEC104 CASDU UCI: iecd.<port>.iec104_casdu	Defines IEC104 common ASDU address. <table border="1"> <tr> <td>Default: 1</td> <td></td> </tr> </table>	Default: 1					
Default: 1							

Web Field/UCI/Package Option	Description
Opt: iec104_casdu	Range
Web: Send EOI UCI: iecd.<port>.iec104_send_eoi Opt: iec104_send_eoi	Enables sending of IEC 104 End Of Initialisation message to the master. Default: 0 1
Web: Enable IEC 62351-5 secure mode UCI: iecd.<port>.iec104_secure_on Opt: iec104_secure_on	Enables IEC 62351-5 security. Default: 0 1
Web: n/a UCI: iecd. <port>.iec104_rtu_dl_start_dt Opt: iec104_rtu_dl_start_dt	Defines the start operation of the RTU data link. Default: 0 The RTU data link is always started and established at startup and kept up. 1 The RTU data link layer is started and established when IEC104 is up and the START DT message from the IEC104 master is received. When the RTU data link comes up: send START DT CONF to the IEC104 master.
Web: n/a UCI: iecd.<port>.iec104_gi_resp_time Opt: iec104_gi_resp_time	Defines the time in milliseconds between sending successive general interrogation response messages. Default: 200 milliseconds Range 50-1000
Web: n/a UCI: iecd.<port>.iec104_tqx_size Opt: iec104_tqx_size	Defines the maximum size of transmit ASDU queue in the application layer (number of frames). Default: 128 Range 2-256
Web: n/a UCI: iecd.<port>.iec104_cmd_delay_time Opt: iec104_cmd_delay_time	Defines the maximum allowable received command age in milliseconds. If set to 0, control commands time verification is disabled. Default: 0 5000 milliseconds 1 1000-60000
Web: n/a UCI: iecd.<port>.iec104_fsm_debug_on Opt: iec104_fsm_debug_on	Enables the log for IEC 104 state transitions and events. Default: 0 Enable 1 Disable
Web: n/a UCI: iecd.<port>.iec104_dump_data Opt: iec104_dump_data	Enables RX/TX Hex dump. Default: 0 Enable 1 Disable
Web: n/a UCI: iecd.<port>.iec104_trace_on Opt: iec104_trace_on	Enables protocol tracing. Default: 0 Enable 1 Disable

44.1.5. Port Settings: IEC 101

The IEC 104 to IEC 101 conversion feature on the router allows converting commands in the control direction, and the responses and process data in the monitor direction, between the SCADA master running the IEC 104 protocol and the remote RTUs running IEC101 protocol over a serial interface.

IEC 104 to IEC 101 conversion can be configured for two modes:

IEC 101 Mode	Description
Unbalanced	In IEC 101 unbalanced mode, the router supports communication of up to 32 IEC 101 slaves connected onto the same serial interface.
Balanced	IEC 101 balanced mode is used in point-to-point configuration. That is, the router is communicating to a single IEC 101 outstation on the serial interface. Each peer, either the controlling station (Master) or controlled station (RTU) can initiate communication in balanced mode.

Port Settings

[Delete](#)

PORT1

[General](#)
[IEC104](#)
[IEC101](#)
[DNP3](#)
[Modbus](#)
[Advanced](#)

IEC101 Station Target IP: Remote IP address of IEC101 station to connects to

IEC101 Station Target TCP Port: Remote TCP port of IEC101 station to connect to

IEC101 Link Mode: Balanced Specifies IEC101 link communication mode

IEC101 Station COT Tx Length: Cause Of Transmission length (1 or 2 bytes)

IEC101 Station COT Source Octet: Most significant octet in the cause of transmission field

IEC101 Station ASDU Addr Length: Length of Common Address of ASDU (1 or 2 bytes)

IEC101 Station Info Object Addr Length: Length of the information object address (1, 2 or 3 bytes)

IEC101 Station poll time: RTU polling interval if line idle (milliseconds)

IEC101 Station Link Addr Length: Length of the link address field (0, 1 or 2 bytes)

The IEC 104 gateway port IEC101 configuration page

Web Field/UCI/Package Option	Description				
Web: IEC101 Station Target IP UCI: iecd.<port>.iec101_target_ip Opt: iec101_target_ip	Defines the remote IP address of the IEC101 station to connect to. <table border="1"> <tr> <td>Default</td> <td>127.0.0.1</td> </tr> <tr> <td>Range</td> <td></td> </tr> </table>	Default	127.0.0.1	Range	
Default	127.0.0.1				
Range					
Web: IEC101 Station Target TCP Port UCI: iecd.<port>.iec101_target_tcpport Opt: iec101_target_tcpport	Defines the remote TCP port of the IEC101 station to connect to. <table border="1"> <tr> <td>Default</td> <td>999</td> </tr> <tr> <td>Range</td> <td></td> </tr> </table>	Default	999	Range	
Default	999				
Range					
Web: IEC101 Link Mode UCI: iecd.<port>.iec101_mode Opt: iec101_mode	Defines the IEC101link communication mode. <table border="1"> <tr> <td>Default</td> <td>Unbalanced</td> </tr> <tr> <td></td> <td>Balanced</td> </tr> </table>	Default	Unbalanced		Balanced
Default	Unbalanced				
	Balanced				
Web: IEC101 Station COT Tx Length UCI: iecd.<port>.iec101_cot_tx_length Opt: iec101_cot_tx_length	Defines the Cause of Transmission length (1 or 2 bytes). <table border="1"> <tr> <td>Default</td> <td>2 bytes</td> </tr> <tr> <td>Range</td> <td></td> </tr> </table>	Default	2 bytes	Range	
Default	2 bytes				
Range					
Web: IEC101 Station COT Source Length UCI: iecd.<port>.iec101_cot_source_octet Opt: iec101_cot_source_octet	Defines the most significant octet in the Cause of Transmission field. <table border="1"> <tr> <td>Default</td> <td>0</td> </tr> <tr> <td></td> <td></td> </tr> </table>	Default	0		
Default	0				
Web: IEC101 Station ASDU Addr Length UCI: iecd.<port>.iec101_asdu_addrln Opt: iec101_asdu_addrln	Defines the length of Common Address of ASDU (1 or 2 bytes). <table border="1"> <tr> <td>Default</td> <td>2 bytes</td> </tr> <tr> <td>Range</td> <td></td> </tr> </table>	Default	2 bytes	Range	
Default	2 bytes				
Range					
Web: IEC101 Station Info Object Addr Length UCI: iecd.<port>.iec101_info_obj_addrln Opt: iec101_info_obj_addrln	Defines the length of the Information Object Address (1, 2 or 3 bytes). <table border="1"> <tr> <td>Default</td> <td>2 bytes</td> </tr> <tr> <td>Range</td> <td></td> </tr> </table>	Default	2 bytes	Range	
Default	2 bytes				
Range					
Web: IEC101 Station Poll Time UCI: iecd.<port>.iec101_data_polling_time Opt: iec101_data_polling_time	Defines the RTU polling interval in milliseconds if the line is idle. <table border="1"> <tr> <td>Default</td> <td>1000 milliseconds</td> </tr> <tr> <td>Range</td> <td></td> </tr> </table>	Default	1000 milliseconds	Range	
Default	1000 milliseconds				
Range					
Web: IEC101 Link Addr Length UCI: iecd.<port>.iec101_link_addrln Opt: iec101_link_addrln	Defines the length of the link address field (0, 1 or 2 bytes). <table border="1"> <tr> <td>Default:1</td> <td>bytes</td> </tr> <tr> <td>Range</td> <td></td> </tr> </table>	Default:1	bytes	Range	
Default:1	bytes				
Range					
Web: n/a UCI: iecd.<port>.iec101_ack_delay Opt: iec101_ack_delay	Defines the time to wait in milliseconds for an IEC101 ACK. <table border="1"> <tr> <td>Default</td> <td>0 seconds</td> </tr> <tr> <td>Range</td> <td></td> </tr> </table>	Default	0 seconds	Range	
Default	0 seconds				
Range					
Web: n/a UCI: iecd.<port>.iec101_frame_rsp_time Opt: iec101_frame_rsp_time	Defines the maximum number of milliseconds before resending an IEC101 frame. <table border="1"> <tr> <td>Default</td> <td>3</td> </tr> <tr> <td>Range</td> <td></td> </tr> </table>	Default	3	Range	
Default	3				
Range					
Web: n/a UCI: iecd.<port>.iec101_max_tx_retry Opt: iec101_max_tx_retry	Defines the maximum number of times to retry sending an IEC101 frame. <table border="1"> <tr> <td>Default</td> <td>3</td> </tr> <tr> <td>Range</td> <td></td> </tr> </table>	Default	3	Range	
Default	3				
Range					
Web: n/a UCI: iecd.<port>.iec101_txq_size	Defines the size of transmit ASDU queue (number of frames) in the IEC101 link layer.				

Web Field/UCI/Package Option	Description				
Opt: iec101_txq_size	<table border="1"> <tr> <td>Default</td> <td>128</td> </tr> <tr> <td>Range</td> <td></td> </tr> </table>	Default	128	Range	
Default	128				
Range					
Web: n/a UCI: iecd.<port>.iec101_send_spont_delay_acq Opt: iec101_send_spont_delay_acq	Defines whether to send DELAY ACQUISITION SPONTANEOUS message as part of 'Acquisition of Transmission Delay' procedure. Note: this option is used in the scenario where an IEC104 Master is talking to an IEC101 RTU. <table border="1"> <tr> <td>Default: 0</td> <td>Do not send DELAY ACQUISITION SPONTANEOUS message.</td> </tr> <tr> <td>1</td> <td>Send DELAY ACQUISITION SPONTANEOUS message.</td> </tr> </table>	Default: 0	Do not send DELAY ACQUISITION SPONTANEOUS message.	1	Send DELAY ACQUISITION SPONTANEOUS message.
Default: 0	Do not send DELAY ACQUISITION SPONTANEOUS message.				
1	Send DELAY ACQUISITION SPONTANEOUS message.				
Web: n/a UCI: iecd.<port>.iec101_fsm_debug_on Opt: iec101_fsm_debug_on	Enables logging IEC104 state transitions and events. <table border="1"> <tr> <td>Default: 0</td> <td></td> </tr> <tr> <td>1</td> <td></td> </tr> </table>	Default: 0		1	
Default: 0					
1					
Web: n/a UCI: iecd.<port>.iec101_dump_data Opt: iec101_dump_data	Enables RX/TX Hex dump. <table border="1"> <tr> <td>Default: 0</td> <td></td> </tr> <tr> <td>1</td> <td></td> </tr> </table>	Default: 0		1	
Default: 0					
1					

44.1.6. Port Settings: DNP3

The IEC 104 to DNP3 conversion feature on the router allows converting commands in the control direction, and the responses and process data in the monitor direction, between the SCADA master running the IEC104 protocol and the remote RTU running DNP3 over serial protocol.

[Delete](#)

PORT1

General IEC104 IEC101 **DNP3** Modbus Advanced

DNP3 Station Target IP: Remote IP address of DNP3 station to connects to

DNP3 Station Target TCP Port: Remote TCP port of DNP3 station to connect to

DNP3 Master Station Address: Local (Master) DNP3 address

DNP3 Outstation Address: Remote (Outstation) DNP3 address

Enable DNP3 Data Link Confirms: Enables DNP3 Data Link Level User Data Confirmations

DNP3 Data Link Keep Alive: DNP3 Data Link Keep Alive interval in milliseconds (0=disable)

DNP3 Frame Response Time: Maximum time allowed to receive frame acknowledge from DNP3 outstation (milliseconds)

DNP3 Maximum Frame Retry: Maximum number of times to retry confirmed frame delivery to DNP3 outstation

DNP3 Outstation Poll Time: DNP3 Outstation Poll Time in milliseconds

Enable DNP3 Unsolicited Responses: Enables DNP3 Application Level Unsolicited Responses

Enable DNP3 Time Synchronization: Enables DNP3 Time Synchronization

The IEC 104 gateway port DNP3 configuration page

Web Field/UCI/Package Option	Description				
Web: DNP3 Station Target IP UCI: iecd.<port>.dnp3_target_ip Opt: dnp3_target_ip	Defines the remote IP address of the DNP3 station to connect to.				
Web: DNP3 Station Target TCP Port UCI: iecd.<port>.dnp3_target_tcpport Opt: dnp3_target_tcpport	Defines the remote TCP port of the DNP3 station to connect to. <table border="1"> <tr> <td>Default</td> <td>999</td> </tr> <tr> <td>Range</td> <td></td> </tr> </table>	Default	999	Range	
Default	999				
Range					
Web: DNP3 Master Station Address UCI: iecd.<port>.dnp3_dl_srcaddr Opt: dnp3_dl_srcaddr	Defines the local (Master) DNP3 address. <table border="1"> <tr> <td>Default: 0</td> <td></td> </tr> <tr> <td>Range</td> <td></td> </tr> </table>	Default: 0		Range	
Default: 0					
Range					
Web: DNP3 Outstation Address UCI: iecd.<port>.dnp3_dl_dstaddr Opt: dnp3_dl_dstaddr	Defines the remote (Outstation) DNP3 address. <table border="1"> <tr> <td>Default: 0</td> <td></td> </tr> <tr> <td>Range</td> <td></td> </tr> </table>	Default: 0		Range	
Default: 0					
Range					
Web: Enable DNP3 Data Link Confirms UCI: iecd.<port>.dnp3_dl_cfrm_user_data Opt: dnp3_dl_cfrm_user_data	Enables DNP3 data link layer user data confirmations. <table border="1"> <tr> <td>Default: 0</td> <td></td> </tr> <tr> <td>Range</td> <td></td> </tr> </table>	Default: 0		Range	
Default: 0					
Range					
Web: DNP3 Data Link Keep Alive UCI: iecd.<port>.dnp3_dl_keep_alive_int Opt: dnp3_dl_keep_alive_int	Defines the DNP3 data link keepalive interval in milliseconds (0 to disable). <table border="1"> <tr> <td>Default</td> <td>15000 milliseconds</td> </tr> <tr> <td>Range</td> <td></td> </tr> </table>	Default	15000 milliseconds	Range	
Default	15000 milliseconds				
Range					
Web: DNP3 Frame Response Time UCI: iecd.<port>.dnp3_dl_frame_rsp_time Opt: dnp3_dl_frame_rsp_time	Defines the maximum amount of time in milliseconds to receive a frame acknowledgement from the DNP3 outstation. <table border="1"> <tr> <td>Default</td> <td>1000 milliseconds</td> </tr> <tr> <td>Range</td> <td></td> </tr> </table>	Default	1000 milliseconds	Range	
Default	1000 milliseconds				
Range					
Web: DNP3 Maximum Frame Retry UCI: iecd.<port>.dnp3_dl_max_tx_retry Opt: dnp3_dl_max_tx_retry	Defines the maximum number of times to retry confirmed frame delivery to the DNP3 outstation.				
Web: DNP3 Outstation Poll Time UCI: iecd.<port>.dnp3_app_poll_time Opt: dnp3_app_poll_time	Defines the DNP3 outstation poll time in milliseconds. <table border="1"> <tr> <td>Default</td> <td>3</td> </tr> <tr> <td>Range</td> <td></td> </tr> </table>	Default	3	Range	
Default	3				
Range					
Web: Enable DNP3 Unsolicited Responses UCI: iecd.<port>.dnp3_app_unsol_enable Opt: dnp3_app_unsol_enable	Enables DNP3 application level unsolicited responses. <table border="1"> <tr> <td>Default: 0</td> <td>Disabled</td> </tr> <tr> <td>1</td> <td>Enabled</td> </tr> </table>	Default: 0	Disabled	1	Enabled
Default: 0	Disabled				
1	Enabled				
Web: Enable DNP3 Time Synchronization UCI: iecd.<port>.dnp3_app_sync_time Opt: dnp3_app_sync_time	Enables DNP3 time synchronisation. <table border="1"> <tr> <td>Default: 0</td> <td>Disabled</td> </tr> <tr> <td>1</td> <td>Enabled</td> </tr> </table>	Default: 0	Disabled	1	Enabled
Default: 0	Disabled				
1	Enabled				
Web: n/a UCI: iecd.<port>.dnp3_dl_utxq_size Opt: dnp3_dl_utxq_size	Defines the size of DNP3 data link transmit unconfirmed service frame queue (number of frames). <table border="1"> <tr> <td>Default</td> <td>128</td> </tr> <tr> <td>Range</td> <td>2-256</td> </tr> </table>	Default	128	Range	2-256
Default	128				
Range	2-256				
Web: n/a	Defines the size of DNP3 data link transmit confirmed service frame queue (number of frames).				

Web Field/UCI/Package Option	Description						
UCI: iecd.<port>.dnp3_dl_ctxq_size Opt: dnp3_dl_ctxq_size	<table border="1"> <tr> <td>Default</td> <td>128</td> </tr> <tr> <td>Range</td> <td>2-256</td> </tr> </table>	Default	128	Range	2-256		
Default	128						
Range	2-256						
Web: n/a UCI: iecd.<port>.dnp3_app_read_attr Opt: dnp3_app_read_attr	Enables reading DNP3 device attributes at the start of the session. This feature is useful for debugging and is not recommended for production.						
Web: n/a UCI: iecd.<port>.dnp3_app_firstpoll_delay Opt: dnp3_app_firstpoll_delay	Defines initial timeout from start-up in milliseconds before performing the first DNP3 integrity poll. <table border="1"> <tr> <td>Default</td> <td>5000 milliseconds</td> </tr> <tr> <td>Range</td> <td>5000-65535</td> </tr> </table>	Default	5000 milliseconds	Range	5000-65535		
Default	5000 milliseconds						
Range	5000-65535						
Web: n/a UCI: iecd.<port>.dnp3_app_evpoll_time Opt: dnp3_app_evpoll_time	Defines DNP3 outstation event polling interval in milliseconds. <table border="1"> <tr> <td>Default</td> <td>3000 milliseconds</td> </tr> <tr> <td>Range</td> <td>1000-65535</td> </tr> </table>	Default	3000 milliseconds	Range	1000-65535		
Default	3000 milliseconds						
Range	1000-65535						
Web: n/a UCI: iecd.<port>.dnp3_app_frag_rx_time Opt: dnp3_app_frag_rx_time	Defines DNP3 application level fragment response timeout. <table border="1"> <tr> <td>Default</td> <td>1000 milliseconds</td> </tr> <tr> <td>Range</td> <td>1000-65535</td> </tr> </table>	Default	1000 milliseconds	Range	1000-65535		
Default	1000 milliseconds						
Range	1000-65535						
Web: n/a UCI: iecd.<port>.dnp3_app_txq_size Opt:n/a	Defines DNP3 application level transmit queue size (number of frames). <table border="1"> <tr> <td>Default</td> <td>64</td> </tr> <tr> <td>Range</td> <td>2-256</td> </tr> </table>	Default	64	Range	2-256		
Default	64						
Range	2-256						
Web: n/a UCI: iecd.<port>.dnp3_app_output_mode Opt: dnp3_app_output_mode	Defines a decimal code that controls how the router sends a DNP3 binary output command to a DNP3 RTU. The most commonly used model is Select/Operate . Note: this command is used where the router is acting as a DNP3 master. <table border="1"> <tr> <td>Default: 0</td> <td>Use WRITE command</td> </tr> <tr> <td>1</td> <td>Use Slect/Operate message sequence</td> </tr> <tr> <td>2</td> <td>Use Direct Operate message</td> </tr> </table>	Default: 0	Use WRITE command	1	Use Slect/Operate message sequence	2	Use Direct Operate message
Default: 0	Use WRITE command						
1	Use Slect/Operate message sequence						
2	Use Direct Operate message						
Web: n/a UCI: iecd.<port>.dnp3_app_evpoll_mode Opt: dnp3_app_evpoll_mode	Defines DNP3 outstation event polling interval in milliseconds. <table border="1"> <tr> <td>Default</td> <td>3000 milliseconds</td> </tr> <tr> <td>Range</td> <td>1000-65535</td> </tr> </table>	Default	3000 milliseconds	Range	1000-65535		
Default	3000 milliseconds						
Range	1000-65535						
Web: n/a UCI: iecd.<port>.dnp3_fsm_debug_on Opt: dnp3_fsm_debug_on	Enables DNP3 link and application level state machine transition and event logging into syslog. <table border="1"> <tr> <td>Default: 1</td> <td>Enabled</td> </tr> <tr> <td>0</td> <td>Disabled</td> </tr> </table>	Default: 1	Enabled	0	Disabled		
Default: 1	Enabled						
0	Disabled						
Web: n/a UCI: iecd.<port>.dnp3_object_parser_debug_on Opt: dnp3_object_parser_debug_on	Enables or disables logging low level debug information when parsing DNP3 objects in the received DNP3 slave messages <table border="1"> <tr> <td>Default: 1</td> <td>Enabled</td> </tr> <tr> <td>2</td> <td>Disabled</td> </tr> </table>	Default: 1	Enabled	2	Disabled		
Default: 1	Enabled						
2	Disabled						
Web: n/a UCI: iecd.<port>.dnp3_dump_data Opt: dnp3_dump_data	Enables RX/TX Hex dump. <table border="1"> <tr> <td>Default: 1</td> <td>Enabled</td> </tr> <tr> <td>2</td> <td>Disabled</td> </tr> </table>	Default: 1	Enabled	2	Disabled		
Default: 1	Enabled						
2	Disabled						
Web: n/a UCI: iecd.<port>.dnp3_trace_on	Enables DNP3 protocol tracing. <table border="1"> <tr> <td>Default: 1</td> <td>Enabled</td> </tr> </table>	Default: 1	Enabled				
Default: 1	Enabled						

Web Field/UCI/Package Option	Description	
Opt: dnp3_trace_on	2	Disabled

44.1.7. Port Settings: Modbus

The IEC 104 to Modbus conversion feature on the router allows converting commands in the control direction and the responses and process data in the monitor direction between the SCADA Master running the IEC 104 protocol and the remote RTUs running Modbus protocol.

The router software supports two variations of the Modbus protocol:

- Modbus over serial: the Modbus devices are connected to the serial interface of the router.
- Modbus TCP: the Modbus devices are located on the IP network reachable from the router.

In the Modbus over serial variation, currently the router supports Modbus 'RTU mode' frame format of the Modbus specification only.

Port Settings Delete

PORT1

General IEC104 IEC101 DNP3 **Modbus** Advanced

Modbus protocol: ⓘ Sets protocol variation used by RTU that connects to this router

Modbus local IP: ⓘ Local IP interface to use in modbus mode

Modbus local port: ⓘ Local port to use in modbus mode

Modbus remotel IP: ⓘ Remote IP address to use in modbus mode

Modbus remote port: ⓘ Remote port to use in modbus mode

Modbus polling time: ⓘ Modbus slave polling interval in milliseconds

Modbus frame response time: ⓘ Maximum time allowed to receive a response frame from a Modbus slave (milliseconds)

The IEC 104 gateway port modbus configuration page

Web Field/UCI/Package Option	Description									
Web: Modbus Protocol UCI: iecd.<port>.modbus_protocol Opt: modbus_protocol	Defines the protocol variation used by RTU that connects to this router. <table border="1"> <thead> <tr> <th>Option</th> <th>Description</th> <th>UCI</th> </tr> </thead> <tbody> <tr> <td>Modbus serial</td> <td>Modbus over serial</td> <td>modbus_serial</td> </tr> <tr> <td>Modbus TCP</td> <td>Modbus over TCP</td> <td>modbus_tcp</td> </tr> </tbody> </table>	Option	Description	UCI	Modbus serial	Modbus over serial	modbus_serial	Modbus TCP	Modbus over TCP	modbus_tcp
Option	Description	UCI								
Modbus serial	Modbus over serial	modbus_serial								
Modbus TCP	Modbus over TCP	modbus_tcp								
Web: Modbus local IP UCI: iecd.<port>.modbus_local_ip Opt: modbus_local_ip	Defines the local IP to use in Modbus mode. <table border="1"> <tbody> <tr> <td>Default</td> <td>0.0.0.0</td> </tr> <tr> <td>Range</td> <td></td> </tr> </tbody> </table>	Default	0.0.0.0	Range						
Default	0.0.0.0									
Range										
Web: Modbus local port UCI: iecd.<port>.modbus_local_port Opt: modbus_local_port	Defines the local port to use in Modbus mode. <table border="1"> <tbody> <tr> <td>Default</td> <td>888</td> </tr> <tr> <td>Range</td> <td></td> </tr> </tbody> </table>	Default	888	Range						
Default	888									
Range										
Web: Modbus remote IP UCI: iecd.<port>.modbus_remote_ip Opt: modbus_remote_ip	Defines the remote IP address. <table border="1"> <tbody> <tr> <td>Default</td> <td>127.0.0.1</td> </tr> <tr> <td>Range</td> <td></td> </tr> </tbody> </table>	Default	127.0.0.1	Range						
Default	127.0.0.1									
Range										
Web: Modbus remote port UCI: iecd.<port>.modbus_remote_port Opt: modbus_remote_port	Defines the remote port. <table border="1"> <tbody> <tr> <td>Default</td> <td>999</td> </tr> <tr> <td>Range</td> <td></td> </tr> </tbody> </table>	Default	999	Range						
Default	999									
Range										
Web: Modbus polling time UCI: iecd.<port>.modbus_polling_time Opt: modbus_polling_time	Defines the slave polling interval in milliseconds. <table border="1"> <tbody> <tr> <td>Default</td> <td>3000</td> </tr> <tr> <td>Range</td> <td></td> </tr> </tbody> </table>	Default	3000	Range						
Default	3000									
Range										
Web: Modbus frame response time UCI: iecd.<port>.modbus_resp_time Opt: modbus_resp_time	Defines in milliseconds the maximum time allowed to receive a response frame from a Modbus slave. <table border="1"> <tbody> <tr> <td>Default</td> <td>1000</td> </tr> <tr> <td>Range</td> <td></td> </tr> </tbody> </table>	Default	1000	Range						
Default	1000									
Range										
Web: n/a UCI: iecd.<port>.modbus_dump_data Opt: modbus_dump_data	Enables RX/TX Hex dump.									
Web: n/a UCI: iecd.<port>.modbus_trace_on Opt: modbus_trace_on	Enables Modbus protocol tracing.									
Web: n/a UCI: iecd.<port>.modbus_fsm_debug_on Opt: modbus_fsm_debug_on	Enables Modbus state machine debugging.									

44.1.8. Port Settings: Advanced

In this section you can configure the advanced port settings.

Port Settings

[Delete](#)

PORT1

General
IEC104
IEC101
DNP3
Modbus
Advanced

Syslog severity Emergency Specifies the lowest severity to be logged by IEC D

Enable TCP keepalives Enable TCP Keepalives

TCP Keepalive interval 5 TCP Keepalive send interval (seconds)

TCP Keepalive timeout 5 TCP Keepalive timeout (seconds)

TCP Keepalive count 3 TCP Keepalive maximum probe count

The IEC 104 gateway port advanced configuration page

Web Field/UCI/Package Option	Description																
Web: Syslog severity UCI: iecd.<port>.loglevel Opt: loglevel	Defines the lowest severity used for logging events by iecd. <table border="1" style="margin-top: 10px;"> <tr><td>0</td><td>Emergency</td></tr> <tr><td>1</td><td>Alert</td></tr> <tr><td>2</td><td>Critical</td></tr> <tr><td>3</td><td>Error</td></tr> <tr><td>4</td><td>Warning</td></tr> <tr><td>5</td><td>Notice</td></tr> <tr><td>6</td><td>Informational</td></tr> <tr><td>7</td><td>Debug</td></tr> </table>	0	Emergency	1	Alert	2	Critical	3	Error	4	Warning	5	Notice	6	Informational	7	Debug
0	Emergency																
1	Alert																
2	Critical																
3	Error																
4	Warning																
5	Notice																
6	Informational																
7	Debug																
Web: Enable TCP keepalives UCI: iecd.<port>.tcp_keepalive_enabled Opt: tcp_keepalive_enabled	Defines whether to enable TCP keepalive. <table border="1" style="margin-top: 10px;"> <tr><td>Default: 1</td><td>Enabled</td></tr> <tr><td>2</td><td>Disabled</td></tr> </table>	Default: 1	Enabled	2	Disabled												
Default: 1	Enabled																
2	Disabled																
Web: TCP Keepalive interval UCI: iecd.<port>.tcp_keepalive_interva Opt: tcp_keepalive_interval	Defines the TCP keepalive interval in seconds. <table border="1" style="margin-top: 10px;"> <tr><td>Default</td><td>5 seconds</td></tr> <tr><td>Range</td><td></td></tr> </table>	Default	5 seconds	Range													
Default	5 seconds																
Range																	
Web: TCP Keepalive timeout UCI: iecd.<port>.tcp_keepalive_timeout Opt: tcp_keepalive_timeout	Defines the TCP keepalive timeout in seconds. <table border="1" style="margin-top: 10px;"> <tr><td>Default</td><td>5 seconds</td></tr> <tr><td>Range</td><td></td></tr> </table>	Default	5 seconds	Range													
Default	5 seconds																
Range																	
Web: TCP Keepalive count UCI: iecd.<port>.tcp_keepalive_count Opt: tcp_keepalive_count	Defines the number of unanswered keepalives before terminating the TCP session. <table border="1" style="margin-top: 10px;"> <tr><td>Default</td><td>3 seconds</td></tr> <tr><td>Range</td><td></td></tr> </table>	Default	3 seconds	Range													
Default	3 seconds																
Range																	
Web: n/a UCI: iecd.<port>.tcp_user_timeout Opt: tcp_user_timeout	Defines the maximum time in milliseconds to wait for a TCP ACK after data transmission before closing the connection in TCP established state. Set to 0 to use kernel defaults (about 15-20 minutes). <table border="1" style="margin-top: 10px;"> <tr><td>Default</td><td>2000 milliseconds</td></tr> <tr><td>Range</td><td></td></tr> </table>	Default	2000 milliseconds	Range													
Default	2000 milliseconds																
Range																	

44.2. IEC 101 Links

The following section defines the IEC 101 slave links used in IEC 101 conversion. Each link is defined by a config `iec101link` section block. There is a maximum of 32 links supported.

In IEC 101 unbalanced mode all of these links can be used. However, as IEC 101 balanced mode is used in a point to point scenario, it is assumed there will be only one outstation per serial port. Only the first link configured for that port will be used. Each peer, either the controlling station (Master) or the controlled station (RTU) can initiate communication in balanced mode.

IEC101 Links		
Port number	IEC101 Link Address	IEC101 Link ASDU Addr
<i>(1..4) Serial port</i>	<i>Link address of the IEC101 station</i>	<i>ASDU address of the IEC101 station</i>
<input type="text" value="1"/>	<input type="text" value="0"/>	<input type="text" value="0"/>
<input type="button" value="Delete"/>		
<input type="button" value="Add"/>		

IEC101 slave links configuration page

Web Field/UCI/Package Option	Description
Web: Port Number UCI: <code>iecd.iec101link[x].portno</code> Opt: <code>portno</code>	Defines the serial port number to which this point belongs.
Web: IEC101 Link Address UCI: <code>iecd.iec101link[x].address</code> Opt: <code>address</code>	Defines the IEC101 station link address.
Web: IEC101 Link ASDU Station UCI: <code>iecd.iec101link[x].asduaddr</code> Opt: <code>asduaddr</code>	Defines the IEC101 station common ASDU address.

44.3. Point Mappings

IEC 104 point mappings are used for DNP3 and Modbus conversion only.

The point mappings comprise the information necessary to perform conversion between each data variable (point) on the remote RTU and the corresponding variable in the IEC 104 domain.

Modbus TCP requires a device route file (`/root/iecd/devroute.csv`) to map the point configuration to an IP address. For more information, read the Modbus route file section below.

There is a maximum of 1200 point mappings supported per serial port.

Points

Delete

Port number	<input type="text" value="1"/>	? (1..4) Serial port
IEC101 Type ID	<input type="text" value="1"/>	? IEC101 Data Type ID
IEC104 Type ID	<input type="text" value="1"/>	? IEC104 Data Type ID
IEC101 IOA	<input type="text" value="1"/>	? IEC101 Information Object Address
IEC104 IOA	<input type="text" value="1"/>	? IEC104 Information Object Address
Device Addr	<input type="text" value="1"/>	? Modbus slave address
DNP3 options	<input type="text" value="0"/>	? DNP3 options bitmap
Group	<input type="text" value="0"/>	? DNP3 group id or Modbus data type
Index	<input type="text" value="0"/>	? DNP3 Point index or Modbus data index
Index2	<input type="text" value="0"/>	? DNP3 Point secondary index
Modbus options	<input type="text" value="0"/>	? Modbus options bitmap
Modbus bitmap mask	<input type="text" value="0"/>	? Modbus bitmap mask
Modbus CtrlMode index	<input type="text" value="0"/>	? Modbus Control Mode register index
Modbus CtrlMode value	<input type="text" value="0"/>	? Modbus Control Mode register value
Local Digital Output GPIO number	<input type="text" value="0"/>	? Local Digital Output GPIO number
IEC61850 DO	<input type="text"/>	? IEC61850 Data Object reference, Maximum 32 characters

The IEC 104 gateway point mapping configuration page

Web Field/UCI/Package Option	Description																																		
Web: Port Number UCI: iecd.point[x].portno Opt: portno	Defines the port number to which this point belongs (1 to 4). This corresponds to the serial port number.																																		
Web: IEC101 Type ID UCI: iecd.point[x].iec101_type_id Opt: iec101_type_id	Defines the IEC101 type ID (data type). All types are defined in IEC-60870-5-104 <table border="1" data-bbox="592 432 1211 1032"> <tr><td>1</td><td>Single point information</td></tr> <tr><td>2</td><td>Double point information</td></tr> <tr><td>7</td><td>Bitstring 32 bits</td></tr> <tr><td>9</td><td>Measured normalised value short signed</td></tr> <tr><td>11</td><td>Measured scaled value short signed</td></tr> <tr><td>13</td><td>IEEE STD 754 - Short floating point number</td></tr> <tr><td>14</td><td>IEEE STD 754 - Short floating point number with time tag CP24Time2a</td></tr> <tr><td>15</td><td>Integrated totals, 32 bit signed integer</td></tr> <tr><td>20</td><td>Packed single point information with status change detection</td></tr> <tr><td>21</td><td>Measured normalised value short signed without quality descriptor</td></tr> <tr><td>30</td><td>Single point information with time tag CP56Time2a</td></tr> <tr><td>31</td><td>Double point information with time tag CP56Time2a</td></tr> <tr><td>33</td><td>Bitstring of 32 bits with time tag CP56Time2a</td></tr> <tr><td>34</td><td>Measure normalised value short signed time tag CP56Time2a</td></tr> <tr><td>35</td><td>Measured value, scaled value with time tag CP56Time2a</td></tr> <tr><td>36</td><td>Measured value, short floating point number with time tag CP56Time 2a</td></tr> <tr><td>37</td><td>Integrated totals with time tag CP56Time2a</td></tr> </table>	1	Single point information	2	Double point information	7	Bitstring 32 bits	9	Measured normalised value short signed	11	Measured scaled value short signed	13	IEEE STD 754 - Short floating point number	14	IEEE STD 754 - Short floating point number with time tag CP24Time2a	15	Integrated totals, 32 bit signed integer	20	Packed single point information with status change detection	21	Measured normalised value short signed without quality descriptor	30	Single point information with time tag CP56Time2a	31	Double point information with time tag CP56Time2a	33	Bitstring of 32 bits with time tag CP56Time2a	34	Measure normalised value short signed time tag CP56Time2a	35	Measured value, scaled value with time tag CP56Time2a	36	Measured value, short floating point number with time tag CP56Time 2a	37	Integrated totals with time tag CP56Time2a
1	Single point information																																		
2	Double point information																																		
7	Bitstring 32 bits																																		
9	Measured normalised value short signed																																		
11	Measured scaled value short signed																																		
13	IEEE STD 754 - Short floating point number																																		
14	IEEE STD 754 - Short floating point number with time tag CP24Time2a																																		
15	Integrated totals, 32 bit signed integer																																		
20	Packed single point information with status change detection																																		
21	Measured normalised value short signed without quality descriptor																																		
30	Single point information with time tag CP56Time2a																																		
31	Double point information with time tag CP56Time2a																																		
33	Bitstring of 32 bits with time tag CP56Time2a																																		
34	Measure normalised value short signed time tag CP56Time2a																																		
35	Measured value, scaled value with time tag CP56Time2a																																		
36	Measured value, short floating point number with time tag CP56Time 2a																																		
37	Integrated totals with time tag CP56Time2a																																		
Web: IEC104 Type ID UCI: iecd.point[x].iec104_type_id Opt: iec104_type_id	Defines the IEC104 type ID (data type). All types are defined in IEC-60870-5-104 <table border="1" data-bbox="592 1099 1211 1700"> <tr><td>1</td><td>Single point information</td></tr> <tr><td>2</td><td>Double point information</td></tr> <tr><td>7</td><td>Bitstring 32 bits</td></tr> <tr><td>9</td><td>Measured normalised value short signed</td></tr> <tr><td>11</td><td>Measured scaled value short signed</td></tr> <tr><td>13</td><td>IEEE STD 754 - Short floating point number</td></tr> <tr><td>14</td><td>IEEE STD 754 - Short floating point number with time tag CP24Time2a</td></tr> <tr><td>15</td><td>Integrated totals, 32 bit signed integer</td></tr> <tr><td>20</td><td>Packed single point information with status change detection</td></tr> <tr><td>21</td><td>Measured normalised value short signed without quality descriptor</td></tr> <tr><td>30</td><td>Single point information with time tag CP56Time2a</td></tr> <tr><td>31</td><td>Double point information with time tag CP56Time2a</td></tr> <tr><td>33</td><td>Bitstring of 32 bits with time tag CP56Time2a</td></tr> <tr><td>34</td><td>Measure normalised value short signed time tag CP56Time2a</td></tr> <tr><td>35</td><td>Measured value, scaled value with time tag CP56Time2a</td></tr> <tr><td>36</td><td>Measured value, short floating point number with time tag CP56Time 2a</td></tr> <tr><td>37</td><td>Integrated totals with time tag CP56Time2a</td></tr> </table>	1	Single point information	2	Double point information	7	Bitstring 32 bits	9	Measured normalised value short signed	11	Measured scaled value short signed	13	IEEE STD 754 - Short floating point number	14	IEEE STD 754 - Short floating point number with time tag CP24Time2a	15	Integrated totals, 32 bit signed integer	20	Packed single point information with status change detection	21	Measured normalised value short signed without quality descriptor	30	Single point information with time tag CP56Time2a	31	Double point information with time tag CP56Time2a	33	Bitstring of 32 bits with time tag CP56Time2a	34	Measure normalised value short signed time tag CP56Time2a	35	Measured value, scaled value with time tag CP56Time2a	36	Measured value, short floating point number with time tag CP56Time 2a	37	Integrated totals with time tag CP56Time2a
1	Single point information																																		
2	Double point information																																		
7	Bitstring 32 bits																																		
9	Measured normalised value short signed																																		
11	Measured scaled value short signed																																		
13	IEEE STD 754 - Short floating point number																																		
14	IEEE STD 754 - Short floating point number with time tag CP24Time2a																																		
15	Integrated totals, 32 bit signed integer																																		
20	Packed single point information with status change detection																																		
21	Measured normalised value short signed without quality descriptor																																		
30	Single point information with time tag CP56Time2a																																		
31	Double point information with time tag CP56Time2a																																		
33	Bitstring of 32 bits with time tag CP56Time2a																																		
34	Measure normalised value short signed time tag CP56Time2a																																		
35	Measured value, scaled value with time tag CP56Time2a																																		
36	Measured value, short floating point number with time tag CP56Time 2a																																		
37	Integrated totals with time tag CP56Time2a																																		
Web: IEC101 IOA UCI: iecd.point[x].iec101_ioa Opt: iec101_ioa	Defines IEC104 information object address. This is how remote an IEC104 SCADA master knows one point from another. <table border="1" data-bbox="592 1794 790 1827"> <tr> <td>Range</td> <td>1-116777215</td> </tr> </table>	Range	1-116777215																																
Range	1-116777215																																		
Web: IEC104 IOA UCI: iecd.point[x].iec104_ioa Opt: iec104_ioa	Defines IEC104 information object address. This is how a remote IEC104 SCADA master knows one point from another. <table border="1" data-bbox="592 1935 790 1968"> <tr> <td>Range</td> <td>1-116777215</td> </tr> </table>	Range	1-116777215																																
Range	1-116777215																																		

<p>Web: Device Addr</p> <p>UCI: iecd.point[x].devaddr</p> <p>Opt: devaddr</p>	<p>Defines the Modbus device address of the RTU (Modbus slave address). Used for identifying the point mapping to IP address in the device route file for Modbus TCP.</p> <p>This is not used in DNP3 mode.</p>												
<p>Web: DNP3 Options</p> <p>UCI: iecd.point[x].dnp3options</p> <p>Opt: dnp3options</p>	<p>For DNP3. Defines the DNP3 options bitmap.</p> <table border="1"> <tr> <td>Default</td> <td>1</td> </tr> <tr> <td>Range</td> <td>1-116777215</td> </tr> </table>	Default	1	Range	1-116777215								
Default	1												
Range	1-116777215												
<p>Web: Group</p> <p>UCI: iecd.point[x].group</p> <p>Opt: group</p>	<p>For DNP3. Defines the DNP3 group number to which this data point maps to.</p> <table border="1"> <tr> <td>Default</td> <td>0</td> </tr> <tr> <td>Range</td> <td>0-255</td> </tr> </table> <p>For Modbus. Defines the Modbus data type.</p> <table border="1"> <tr> <td>Default: 0</td> <td>Discreet input</td> </tr> <tr> <td>1</td> <td>Input register</td> </tr> <tr> <td>2</td> <td>Holding register</td> </tr> <tr> <td>3</td> <td>Coil</td> </tr> </table>	Default	0	Range	0-255	Default: 0	Discreet input	1	Input register	2	Holding register	3	Coil
Default	0												
Range	0-255												
Default: 0	Discreet input												
1	Input register												
2	Holding register												
3	Coil												
<p>Web: Index</p> <p>UCI: iecd.point[x].index</p> <p>Opt: index</p>	<p>For DNP3. Defines the DNP3 point index.</p> <p>For Modbus. Defines the Modbus data index (point number).</p> <table border="1"> <tr> <td>Default</td> <td>0</td> </tr> <tr> <td>Range</td> <td>0-65535</td> </tr> </table>	Default	0	Range	0-65535								
Default	0												
Range	0-65535												
<p>Web: Index2</p> <p>UCI: iecd.point[x].index2</p> <p>Opt: index2</p>	<p>For DNP3. Defines the DNP3 secondary point index.</p> <p>For Modbus. Defines the Modbus data index (point number).</p> <table border="1"> <tr> <td>Default</td> <td>0</td> </tr> <tr> <td>Range</td> <td>0-65535</td> </tr> </table>	Default	0	Range	0-65535								
Default	0												
Range	0-65535												
<p>Web: Modbus options</p> <p>UCI: iecd.point[x].mb_options</p> <p>Opt: mb_options</p>	<p>For Modbus. Defines the Modbus options bitmap.</p> <table border="1"> <tr> <td>Default</td> <td>0</td> </tr> <tr> <td>Range</td> <td>0-65535</td> </tr> </table>	Default	0	Range	0-65535								
Default	0												
Range	0-65535												
<p>Web: Modbus bitmap mask</p> <p>UCI: iecd.point[x].bitmap_mask</p> <p>Opt: bitmap_mask</p>	<p>For Modbus. Defines the Modbus bitmap mask.</p> <table border="1"> <tr> <td>Default</td> <td>0</td> </tr> <tr> <td>Range</td> <td>0-65535</td> </tr> </table>	Default	0	Range	0-65535								
Default	0												
Range	0-65535												
<p>Web: Modbus CtrlMode index</p> <p>UCI: iecd.point[x].ctrlmode_index</p> <p>Opt: ctrlmode_index</p>	<p>For Modbus. Defines the Modbus control mode register index.</p> <table border="1"> <tr> <td>Default</td> <td>0</td> </tr> <tr> <td>Range</td> <td>0-65535</td> </tr> </table>	Default	0	Range	0-65535								
Default	0												
Range	0-65535												
<p>Web: Modbus CtrlMode value</p> <p>UCI: iecd.point[x].ctrlmode_val</p> <p>Opt: ctrlmode_val</p>	<p>For Modbus. Defines the Modbus control mode register value.</p> <table border="1"> <tr> <td>Default</td> <td>0</td> </tr> <tr> <td>Range</td> <td>0-65535</td> </tr> </table>	Default	0	Range	0-65535								
Default	0												
Range	0-65535												
<p>Web: Local Digital Output GPIO number</p> <p>UCI: iecd.point[x].local_gpio_output_nr</p> <p>Opt: local_gpio_output_nr</p>	<p>Defines the local digital output GPIO number.</p> <table border="1"> <tr> <td>Default</td> <td>0</td> </tr> <tr> <td>Range</td> <td>0-65535</td> </tr> </table>	Default	0	Range	0-65535								
Default	0												
Range	0-65535												
<p>Web: IEC61850 DO</p> <p>UCI: iecd.point[x].iec61850_do</p>	<p>Defines the IEC61850 Data Object reference. (Maximum 32 characters).</p> <table border="1"> <tr> <td>Default</td> <td>0</td> </tr> </table>	Default	0										
Default	0												

Opt: iec61850_do	Range	0-32 characters
Web: n/a UCI: iecd.point[x].dword Opt: dword	Defines the DWORD type. Relevant for Modbus data types IR (input registers) and HR (holding registers).	
	Default: 0	Data point is treated as 16 bit wide
	1	Data point is treated as 32 bit wide. Two consecutive 16 bit registers are read from the Modbus device.

MODBUS device route file

If the configured MODBUS protocol variation is Modbus TCP, then the device route file at

`/root/iecd/devroute.csv` is used to map the device address (`iecd.point[x].devaddr`) from the point mapping to the remote IP address of the Modbus TCP slave device.

The `devroute.csv` file entries will have the following format:

`<Modbus device addr>, <IP address>`

For example, for the point mapping file, enter:

```
config point
option portno 1
option iec104_type_id 30
option iec104_ioa 64213
option devaddr 1
option group 0
option index 2
```

For the `devroute.csv` entry, enter:

```
1,192.168.0.106
```

44.4. IEC 104 Gateway Configuration Using Command Line

The IEC104 gateway uses the `iecd` package `/etc/config/iecd`. You can configure multiple port, `iec101link` and `points` sections.

By default, IEC104 gateway port instances are named `port`. It is identified by `@port` followed by the port position in the package as a number. For example, for the first port in the package using UCI:

```
iecd.@port[0]=port
iecd.@port[0].enable=1
```

Or using package options:

```
config port
option enable '1'
```

By default, all IEC104 gateway IEC101 link instances are named `iec101link`, the instance is identified by `@iec101link` followed by the link position in the package as a number.

For example, for the first IEC101 link in the package using UCI:

```
iecd.@iec101link[0]=iec101link
iecd.@iec101link[0].portno=1
```

Or using package options:

```
config iec101link
option portno '1'
```

By default, all IEC104 gateway point instances are named point, it is identified by @point followed by the point position in the package as a number. For example, for the first point in the package using UCI:

```
iecd.@point[0]=point
iecd.@point[0].portno=1
```

Or using package options:

```
config point
option portno '1'
```

44.5. IEC 104 To IEC 101 Conversion (Balanced Or Unbalanced)

The following example shows IEC 104 to IEC 101 unbalanced conversion with one IEC 101 link.

To configure IEC 104 to IEC 101 balanced conversion set option iec101_mode to

IEC 104 to IEC 101 using UCI

```
root@VA_router:~# uci show iecd
iecd.main=iecd
iecd.main.enable=1
iecd.port1=port
iecd.port1.enable=1
iecd.port1.loglevel=5
iecd.port1.tcp_keepalive_enabled=1
iecd.port1.tcp_keepalive_interval=5
iecd.port1.tcp_keepalive_timeout=5
iecd.port1.tcp_keepalive_count=3
iecd.port1.tcp_user_timeout=20000
iecd.port1.master_protocol=iec101
iecd.port1.slave_protocol=iec104
iecd.port1.ioa_offset=0
iecd.port1.pointmap_file=/root/iecd/iecd_points1.csv
iecd.port1.iec104_local_ip=0.0.0.0
iecd.port1.iec104_local_tcpport=2404
iecd.port1.iec104_k=12
iecd.port1.iec104_w=9
iecd.port1.iec104_t2=10000
iecd.port1.iec104_gi_resp_time=200
iecd.port1.iec104_txq_size=128
iecd.port1.iec104_sync_time=1
iecd.port1.iec104_time_tagged_cmds=0
iecd.port1.iec104_cmd_delay_time=5000
iecd.port1.iec104_fsm_debug_on=0
iecd.port1.iec104_dump_data=0
iecd.port1.iec104_trace_on=0

#IEC101 conversion options
iecd.port1.iec101_target_ip=127.0.0.1
iecd.port1.iec101_target_tcpport=999
iecd.port1.iec101_mode=unbalanced #balanced or unbalanced
iecd.port1.iec101_cot_tx_length=1
iecd.port1.iec101_cot_source_octet=0
iecd.port1.iec101_asdu_addrln=1
iecd.port1.iec101_info_obj_addrln=2
```

```
iecd.port1.iec101_data_polling_time=500
iecd.port1.iec101_ack_delay=0
iecd.port1.iec101_link_addrln=1
iecd.port1.iec101_frame_rsp_time=2000
iecd.port1.iec101_max_tx_retry=3
iecd.port1.iec101_txq_size=128
iecd.port1.iec101_send_spont_delay_acq=1
iecd.port1.iec101_fsm_debug_on=0
iecd.port1.iec101_dump_data=0
iecd.port1.iec101_trace_on=0
```

The following section defines IEC101 slave links used in IEC101 unbalanced mode on each link is defined by a config block 'config iec101link'

To add more links repeat the section block for each added link. # Maximum 32 links are supported

```
iecd.@iec101link[0]=iec101link
iecd.@iec101link[0].portno=1
iecd.@iec101link[0].address=6
iecd.@iec101link[0].asduaddr=6
#No data point mappings for IEC104 to IEC101 conversion
```

IEC 104 to IEC 101 using Package Options

```
root@VA_router:~# uci export iecd
package iecd
config iecd 'main'
option enable '1'
config port 'port1'
option enable '1'
option loglevel '5'
option tcp_keepalive_enabled '1'
option tcp_keepalive_interval '5'
option tcp_keepalive_timeout '5'
option tcp_keepalive_count '3'
option tcp_user_timeout '20000'
option master_protocol 'iec101'
option slave_protocol 'iec104'
option ioa_offset '0'
option pointmap_file '/root/iecd/iecd_points1.csv'
option iec104_local_ip '0.0.0.0'
option iec104_local_tcpport '2404'
option iec104_k '12'
option iec104_w '9'
option iec104_t2 '10000'
option iec104_gi_resp_time '200'
option iec104_txq_size '128'
option iec104_sync_time '1'
option iec104_time_tagged_cmds '0'
option iec104_cmd_delay_time '5000'
option iec104_fsm_debug_on '0'
option iec104_dump_data '0'
option iec104_trace_on '0'
#IEC101 conversion options
option iec101_target_ip '127.0.0.1'
option iec101_target_tcpport '999'
option iec101_mode 'unbalanced' #balanced or unbalanced
```

```

option iec101_cot_tx_length '1'

option iec101_cot_source_octet '0'

option iec101_asdu_addrln '1'

option iec101_info_obj_addrln '2'

option iec101_data_polling_time '500'

option iec101_ack_delay '0'

option iec101_link_addrln '1'

option iec101_frame_rsp_time '2000'

option iec101_max_tx_retry '3'

option iec101_txq_size '128'

option iec101_send_spont_delay_acq '1'

option iec101_fsm_debug_on '0'

option iec101_dump_data '0'

option iec101_trace_on '0'

# The following section defines IEC101 slave links used in IEC101 unbalanced mode on
# Each link is defined by a config block 'config iec101link'

# To add more links repeat the section block for each added link. To remove links, simply remove the link block from the configuration
# Maximum 32 links are supported

# Definition of options within the section block:
# portno - port number to which this point belongs (1 to 4) # address - IEC101 slave link address
# asduaddr IEC101 slave common ASDU address

config iec101link
option portno 1
option address 6
option asduaddr 6

#No data point mappings for IEC104 to IEC101 conversion

```

44.6. IEC104 To Modbus Conversion

The following example shows IEC104 to Modbus over serial.

To configure Modbus TCP, set `option modbus_protocol` to `modbus_tcp`.

When configuring Modbus TCP, the device route file at `/root/iecd/devroute.csv` must be configured to map the device address `option devaddr` from the point mapping to the remote IP address of the Modbus TCP slave device.

The `devroute.csv` file entries will have the following format:

```
<Modbus device addr>, <IP address>
```

For example, for the point mapping file:

```
config point
option portno 1
option iec104_type_id 30
option iec104_ioa 64213
option devaddr 1
option group 0
option index 2
```

For the devroute.csv entry:

```
1,192.168.0.106
```

44.6.1. IEC104 To Modbus Using UCI

```
root@VA_router:~# uci show iecd
iecd.main=iecd
iecd.main.enable=1
iecd.port1=port
iecd.port1.enable=1
iecd.port1.loglevel=5
iecd.port1.tcp_keepalive_enabled=1
iecd.port1.tcp_keepalive_interval=5
iecd.port1.tcp_keepalive_timeout=5
iecd.port1.tcp_keepalive_count=3
iecd.port1.tcp_user_timeout=20000
iecd.port1.master_protocol=modbus
iecd.port1.slave_protocol=iec104
iecd.port1.ioa_offset=0
iecd.port1.pointmap_file=/root/iecd/iecd_points1.csv
iecd.port1.iec104_local_ip=0.0.0.0
iecd.port1.iec104_local_tcpport=2404
iecd.port1.iec104_k=12
iecd.port1.iec104_w=9
iecd.port1.iec104_t2=10000
iecd.port1.iec104_gi_resp_time=200
iecd.port1.iec104_txq_size=128
iecd.port1.iec104_sync_time=1
iecd.port1.iec104_time_tagged_cmds=0
iecd.port1.iec104_cmd_delay_time=5000
iecd.port1.iec104_fsm_debug_on=0
iecd.port1.iec104_dump_data=0
iecd.port1.iec104_trace_on=0
iecd.port1.iec101_cot_source_octet=0
```

Modbus Conversion Options

```
iecd.port1.modbus_protocol=modbus_serial
iecd.port1.modbus_local_ip=0.0.0.0
iecd.port1.modbus_local_port=888
iecd.port1.modbus_remote_ip=127.0.0.1
iecd.port1.modbus_remote_port=999
iecd.port1.modbus_polling_time=3000
iecd.port1.modbus_resp_time=1000
iecd.port1.modbus_dump_data=0
iecd.port1.modbus_trace_on=0
iecd.port1.modbus_fsm_debug_on=0
```

Modbus Data Point Mappings

```
iecd.@point[0]=point
iecd.@point[0].portno=1
iecd.@point[0].iec104_type_id=36
iecd.@point[0].iec104_ioa=6620161
iecd.@point[0].iec101_ioa=0
iecd.@point[0].devaddr=11
iecd.@point[0].group=1
iecd.@point[0].index=18459
iecd.@point[0].dword=1
iecd.@point[1]=point
iecd.@point[1].portno=1
iecd.@point[1].iec104_type_id=36
iecd.@point[1].iec104_ioa=6620162
iecd.@point[1].iec101_ioa=0
iecd.@point[1].devaddr=11
iecd.@point[1].group=1
iecd.@point[1].index=18461
iecd.@point[1].dword=1
```

IEC 104 to Modbus using Package Options

```
root@VA_router:~# uci export iecd

package iecd

config iecd 'main'

option enable '1'

config port 'port1'

option enable '1'

option loglevel '5'

option tcp_keepalive_enabled '1'

option tcp_keepalive_interval '5'

option tcp_keepalive_timeout '5'

option tcp_keepalive_count '3'

option tcp_user_timeout '20000' option master_protocol 'modbus' option slave_protocol 'iec104' option ioa_offset '0'

option pointmap_file '/root/iecd/iecd_points1.csv' option iec104_local_ip '0.0.0.0'

option iec104_local_tcpport '2404'

option iec104_k '12'

option iec104_w '9'

option iec104_t2 '10000'

option iec104_gi_resp_time '200'

option iec104_txq_size '128'

option iec104_sync_time '1'

option iec104_time_tagged_cmds '0'

option iec104_cmd_delay_time '5000'

option iec104_fsm_debug_on '0'

option iec104_dump_data '0'

option iec104_trace_on '0'

option iec101_cot_source_octet '0'
```

Modbus Conversion Options

```

option modbus_protocol 'modbus_serial'

option modbus_local_ip '0.0.0.0'

option modbus_local_port '888'

option modbus_remote_ip '127.0.0.1'

option modbus_remote_port '999'

option modbus_polling_time '3000'

option modbus_resp_time '1000'

option modbus_dump_data '0'

option modbus_trace_on '0'

option modbus_fsm_debug_on '0'

config point

option portno '1'

option iec104_type_id '36'

option iec104_ioa '6620161'

option iec101_ioa '0'

option devaddr '11'

option group '1'

option index '18459'

option dword '1'

config point

option portno '1'

option iec104_type_id '36'

option iec104_ioa '6620162'

option iec101_ioa '0'

option devaddr '11'

option group '1'

option index '18461'

option dword '1'

```

44.7. Configuring The Terminal Server

The terminal server is used to control the data from the serial port over the IP network.

The terminal server configuration can be found at **Services -> Terminal Server**. The Terminal Server Configuration page appears. You must configure two main sections: Main Settings and Port Settings.

The terminal server for IEC104 to each of the RTU protocol conversions differ only slightly. This section shows the command line options for configuring the terminal server for IEC104 conversion.

For more detailed information on configuring the terminal server using the web GUI and

option values, read the chapter, 'Configuring terminal server'.

Configuring the Terminal Server for IEC 104 to IEC 101 using UCI

```
root@VA_router:~# uci show tservd
tservd.main=tservd
tservd.main.enable=1
tservd.main.debug_ev_enable=0
tservd.main.log_severity=5
tservd.main.debug_rx_tx_enable=0
tservd.port1=port
tservd.port1.enable=1
tservd.port1.devName=/dev/ttySC0
tservd.port1.ip_port1=0
tservd.port1.ip_port2=0
tservd.port1.remote_ip1=0.0.0.0
tservd.port1.remote_ip2=0.0.0.0
tservd.port1.tcp_always_on=1
tservd.port1.close_tcp_on_dsr=0
tservd.port1.tty_always_open=1
tservd.port1.fwd_timeout=0
tservd.port1.fwd_timer_mode=idle
tservd.port1.fwd_buffer_size=1
tservd.port1.sfwd_buffer_size=0
tservd.port1.sfwd_timeout=0
tservd.port1.sfwd_timer_mode=idle
tservd.port1.speed=9600
tservd.port1.wsize=8
tservd.port1.parity=1
tservd.port1.stops=1
tservd.port1.fc_mode=0
tservd.port1.disc_time_ms=5000
tservd.port1.server_mode=1
tservd.port1.proxy_mode=0
tservd.port1.local_ip=0.0.0.0
tservd.port1.listen_port=999
tservd.port1.udpMode=0
tservd.port1.udpLocalPort=0
tservd.port1.udpRemotePort=0
tservd.port1.udpKaIntervalMs=0
```

```
tserverd.port1.udpKaCount=3
tserverd.port1.serial_mode_gpio_control=1
tserverd.port1.tcp_nodelay=1
tserverd.port1.portmode=rs232
```

Configuring IEC 104 to IEC 101 using Package Options

```
root@VA_router:~# uci export tserverd
package tserverd

config tserverd main
# set to 1 to enable terminal server
option enable 1

# enables detailed debug logging (state transitions, data transfer etc)
option debug_ev_enable 0

# sets syslog level (0 to 7), default is 6
option log_severity 5
```

```

option debug_rx_tx_enable 0

config port 'port1'

# enables this port option enable 1

# serial device name

option devName '/dev/ttySC0'

# destination peer port IP number (two number for failover) option ip_port1 0

option ip_port2 0

# destination peer ip address (two addresses for failover) option remote_ip1 '0.0.0.0'

option remote_ip2 '0.0.0.0'

# keep TCP session always connected option tcp_always_on 1

# close TCP session on detection of DSR signal low option close_tcp_on_dsr 0

# keep serial port always open (if option not present, default is 0) option tty_always_open 1

# Forwarding timeout in milliseconds (serial to network)

option fwd_timeout 0

# Forwarding timer mode (serial to network), 'idle'=timer re-started on each received data,
# 'aging'=timer started on first rx

option fwd_timer_mode 'idle'

# Forwarding buffer size (serial to network)

option fwd_buffer_size 1

# Forwarding buffer size (network to serial), 0=use maximum possible network rx buffer size

option sfwd_buffer_size 0

# Forwarding timeout in milliseconds (network to serial), 0=forward to serial immediately

option sfwd_timeout 0

# Forwarding timer mode (network to serial), 'idle'=timer re-started on each received data,
# 'aging'=timer started on first rx

option sfwd_timer_mode 'idle'

# serial device speed in baud

option speed 9600

# serial device word size (5,6,7,8)

option wsize 8

# serial device parity (0=none, 1=even, 2=odd)

option parity 1

# serial device number of stop bits (1 or 2)

option stops 1

# serial flow control mode (0=none, 1=RTS CTS, 2=XONXOFF)

option fc_mode 0

```

```

# time in milliseconds to start re-connecting after setting DTR low

option disc_time_ms 5000

# TCP server mode

option server_mode 1

# Proxy mode (off by default)

option proxy_mode 0

# Local IP address to listen on (0.0.0.0=listen on any interface)

option local_ip '0.0.0.0'

# TCP listen port for server mode

option listen_port 999

# UDP mode

option udpMode 0

# UDP local port UDP mode

option udpLocalPort 0

# UDP port for UDP mode

option udpRemotePort 0

# If set to non zero, send empty UDP packets every this many milliseconds to remote peer

option udpKaIntervalMs 0

# Max number of consecutive remote UDP keepalive missed (not received) before UDP

# session considered broken

option udpKaCount 3

option serial_mode_gpio_control 1

option tcp_nodelay 1

# rs232 - RS-232 mode, rs485hdx - rs485 2 wire half duplex mode in which transmitter drives

# RTS. rs485fdx - RS485 4 wire full duplex mode. 'v23' - using V.23 leased line card driver.

# x21 - use USB serial card in sync mode

option portmode 'rs232'

```

44.7.1. Configuring The Terminal Server For IEC104 To DNP3

The terminal server configuration for IEC104 to DNP3 is the same as for IEC104 to IEC101 except for serial device parity which is set to **none**.

Parity setting using uci:

```
tservd.port1.parity=1
```

Parity setting using package options:

```
option parity 0
```

44.7.2. Configuring The Terminal Server For IEC 104 To Modbus Over Serial

The terminal server is only used for IEC104 to Modbus over serial. It is not used for Modbus over TCP.

The options necessary for IEC104 to Modbus configuration are listed below. These options are for the first serial port only.

IEC104 to Modbus over Serial using UCI

```
root@VA_router:~# uci show tserverd
tserverd.main=tserverd
tserverd.main.enable=1
tserverd.main.debug_ev_
enable=0 tserverd.main.log_severity=5
tserverd.main.debug_rx_tx_enable=0
tserverd.port1=port tserverd.port1.enable=1
tserverd.port1.devName=/dev/ttySC0
tserverd.port1.ip_port1=999
tserverd.port1.ip_port2=999
tserverd.port1.remote_ip1=127.0.0.1
tserverd.port1.remote_ip2=127.0.0.1
tserverd.port1.tcp_always_on=1
tserverd.port1.close_tcp_on_dsr=0
tserverd.port1.tty_always_open=1
tserverd.port1.fwd_timeout=10
tserverd.port1.fwd_timer_mode=idle
tserverd.port1.fwd_buffer_size=300
tserverd.port1.sfwd_buffer_size=0
tserverd.port1.sfwd_timeout=0
tserverd.port1.sfwd_timer_mode=idle
tserverd.port1.speed=19200
tserverd.port1.wsize=8
tserverd.port1.parity=1
tserverd.port1.stops=1
tserverd.port1.fc_mode=0
tserverd.port1.disc_time_ms=5000
tserverd.port1.server_mode=1
tserverd.port1.proxy_mode=0
tserverd.port1.local_ip=0.0.0.0
tserverd.port1.listen_port=999
tserverd.port1.udpMode=1
tserverd.port1.udpLocalPort=999
tserverd.port1.udpRemotePort=888
tserverd.port1.udpKaIntervalMs=0
tserverd.port1.udpKaCount=3
```



```
tserverd.port1.serial_mode_gpio_control=1  
tserverd.port1.portmode=rs232
```

IEC104 to Modbus over serial using package options

```

root@VA_router:~# uci export
tserverd package tserverd

config tserverd main
# set to 1 to enable terminal server
option enable 1
# enables detailed debug logging (state transitions, data transfer etc)
option debug_ev_enable 0
# sets syslog level (0 to 7), default is 6
option log_severity 5
option debug_rx_tx_enable 0
config port 'port1'
# enables this port
option enable 1

# serial device name
option devName '/dev/ttySC0'
destination peer port IP number (two number for failover)
option ip_port1 999
option ip_port2 999
# destination peer ip address (two addresses for failover)
option remote_ip1 '127.0.0.1'
option remote_ip2 '127.0.0.1'
# keep TCP session always connected
option tcp_always_on 1
# close TCP session on detection of DSR signal low
option close_tcp_on_dsr 0
# keep serial port always open (if option not present, default is 0)
option tty_always_open 1
# Forwarding timeout in milliseconds (serial to network)
option fwd_timeout 10
# Forwarding timer mode (serial to network), 'idle'=timer re-started on each received data,
# 'aging'=timer started on first rx
option fwd_timer_mode 'idle'
# Forwarding buffer size (serial to network)
option fwd_buffer_size 300
# Forwarding buffer size (network to serial), 0=use maximum possible network rx buffer size

```

```
option sfwd_buffer_size 0
# Forwarding timeout in milliseconds (network to serial), 0=forward to serial immediately
option sfwd_timeout 0
# Forwarding timer mode (network to serial), 'idle'=timer re-started on each received data,
# 'aging'=timer started on first rx
option sfwd_timer_mode 'idle'
# serial device speed in baud
option speed 19200
# serial device word size (5,6,7,8)
option wsize 8
# serial device parity (0=none, 1=even, 2=odd)
option parity 1
# serial device number of stop bits (1 or 2)
option stops 1
# serial flow control mode (0=none, 1=RTS CTS, 2=XONXOFF)
option fc_mode 0
# time in milliseconds to start re-connecting after setting DTR low
option disc_time_ms 5000
# TCP server mode
option server_mode 1
# Proxy mode (off by default)
option proxy_mode 0
# Local IP address to listen on (0.0.0.0=listen on any interface)
option local_ip '0.0.0.0'
# TCP listen port for server mode
option listen_port 999
# UDP mode
option udpMode 1
# UDP local port UDP mode
option udpLocalPort 999
# UDP port for UDP mode
option udpRemotePort 888
# If set to non zero, send empty UDP packets every this many milliseconds to remote peer
option udpKaIntervalMs 0
# Max number of consecutive remote UDP keepalive missed (not received) before UDP
# session considered broken
```

```

option udpKaCount 3

option serial_mode_gpio_control 1

# rs232 - RS-232 mode, rs485hdx - rs485 2 wire half duplex mode in which transmitter
drives

# RTS. rs485fdx - RS485 4 wire full duplex mode. 'v23' - using V.23 leased line card driver.

# x21 - use USB serial card in sync mode

option portmode 'rs232'

```

44.8. Configuring IEC61850 To IEC101 Conversion

The IEC61850 to IEC101-unbalanced conversion feature of the router allows converting commands in the control direction and the responses and process data in the monitor direction between the SCADA master running the IEC61850 protocol and the remote RTUs running IEC101 protocol in unbalanced mode over serial interface.

In IEC101 unbalanced mode, the router supports communication of up to 32 IEC101 slaves connected onto the same serial interface.

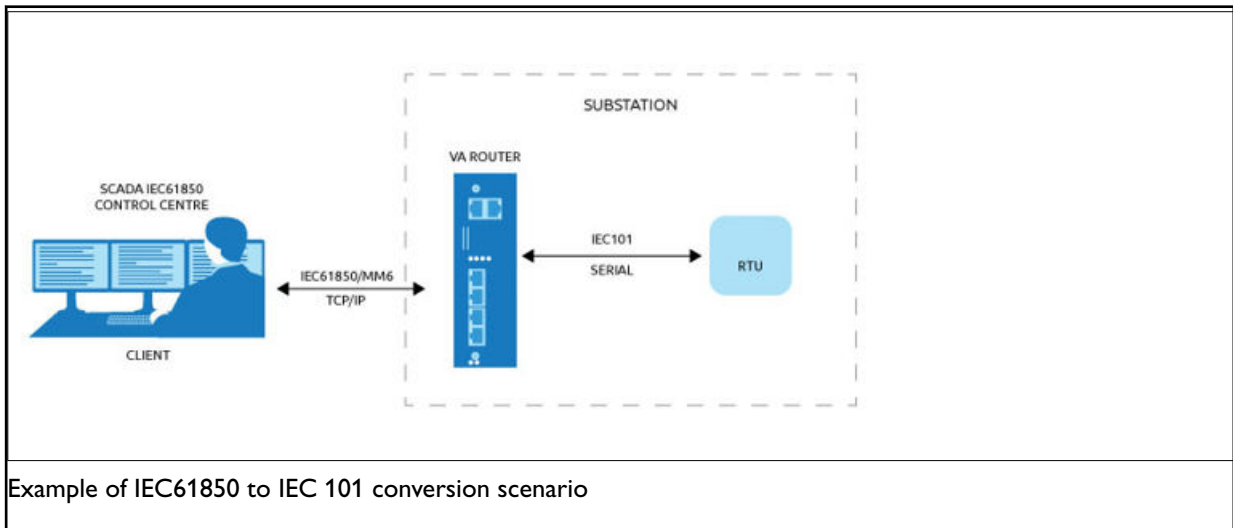

Example of IEC61850 to IEC 101 conversion scenario

The IEC104 gateway and terminal server are used for IEC61850 to IEC101 conversion, as in the other protocol conversions however the IEC62850 options are currently not available via the web interface. The following section details command line configuration.

Web Field/UCI/Package Option	Description				
iecd port Config Section					
Web: n/a UCI: iecd.<port>.slave_protocol Opt: slave_protocol	Defines what protocol the SCADA control centre is using to connect to this gateway. <table border="1"> <tr> <td>Default: iec104</td> <td>IC104</td> </tr> <tr> <td>iec61850</td> <td>IEC61850</td> </tr> </table>	Default: iec104	IC104	iec61850	IEC61850
Default: iec104	IC104				
iec61850	IEC61850				
Web: n/a UCI: iecd.<port>.iec61850_local_ip Opt: iec61850_local_ip	Defines the local IP address this IEC61850 peer binds to.				
Web: n/a UCI: iecd.<port>.iec61850_local_tcpport Opt: iec61850_local_tcpport	Defines the local TCP port this IEC104 peer listens on. <table border="1"> <tr> <td>Default</td> <td>2404</td> </tr> <tr> <td>Range</td> <td>1-65535</td> </tr> </table>	Default	2404	Range	1-65535
Default	2404				
Range	1-65535				
iecd point Config Section					
Web: n/a UCI: iecd.point[x].iec61850_id Opt: iec61850_id	Defines the IEC61850 logical device name. For example: <pre>option iec61850_id 'SENSORS'</pre> <table border="1"> <tr> <td>Range</td> <td>0-32 characters</td> </tr> </table>	Range	0-32 characters		
Range	0-32 characters				
Web: n/a UCI: iecd.point[x].iec61850_ln Opt: iec61850_ln	Defines the IEC61850 logical node name. For example: <pre>option iec61850_ln 'LLN0'</pre> <table border="1"> <tr> <td>Range</td> <td>0-32 characters</td> </tr> </table>	Range	0-32 characters		
Range	0-32 characters				
Web: n/a UCI: iecd.point[x].iec61850_do Opt: iec61850_do	Defines the IEC61850 data object name. For example: <pre>option iec61850_do 'SPS01'</pre> <table border="1"> <tr> <td>Range</td> <td>0-32 characters</td> </tr> </table>	Range	0-32 characters		
Range	0-32 characters				
Web: n/a UCI: iecd.point[x].iec101_type_id Opt: iec101_type_id	Defines the IEC104 type ID (data type). For example: 1 – Single Point Information 2 – Double Point Information All types are defined in IEC-60870-5-101.				
Web: IEC101 IOA UCI: iecd.point[x].iec101_ioa Opt: iec101_ioa	Defines IEC101 information object address. <table border="1"> <tr> <td>Default: 1</td> <td>Single point Information</td> </tr> <tr> <td>Range</td> <td>1-16777215</td> </tr> </table>	Default: 1	Single point Information	Range	1-16777215
Default: 1	Single point Information				
Range	1-16777215				

Relation of IEC 101 Data Types to IEC 61859 Data Type

Supported data type combinations are listed below:

option iec101_type_id (IEC101 explanation)	option iec61850_do (IEC61850 explanation)	IEC101 point R/W	IEC61850 point R/W
'1' SPI (Single Point Information)	'SPS' Single-point status	read only	read only
'1' SPI (Single Point Information)	'SPC' Controllable single-point	read-write	read-write
'1' SPI (Single Point Information)	'SPG' Single point setting	--	write only
'3' DPI (Double Point Information)	'DPS' Double-point status	read only	read only
'3' DPI (Double Point Information)	'DPC' Controllable double-point	read-write	read-write
'11' Measured value, scaled value short signed	'INS' Integer status	read only	read only
'11' Measured value, scaled value short signed	'STV' Status value	read only	read only
'11' Measured value, scaled value short signed	'ENS' Enumerated Status	read only	read only
'11' Measured value, scaled value short signed	'ENC' Controllable enumerated status	read-write	read-write
'11' Measured value, scaled value short signed	'ENG' Enumerated status setting	--	write only
'11' Measured value, scaled value short signed	'INC' Controllable integer status	read-write	read-write
'11' Measured value, scaled value short signed	'CMD' Command	--	write only
'11' Measured value, scaled value short signed	'ING' Integer status setting	--	write only
'11' Measured value, scaled value short signed	'MV' Measured Value	read only	read only
'13' Measured value, short floating point number	'MV' Measured Value	read only	read only
'13' Measured value, short floating point number	'APC' Controllable analog set point	read-write	read-write
'13' Measured value, short floating point number	'SPV' Set point value	--	write only
'13' Measured value, short floating point number	'ASG' Analog setting	--	write only

44.8.1. IEC 61850 To IEC 101 Conversion Using UCI

```
root@VA_router:~# uci show iecd
iecd.main=iecd iecd.main.enable=1
iecd.port1=port iecd.port1.enable=1
iecd.port1.loglevel=5
iecd.port1.tcp_keepalive_enabled=1
iecd.port1.tcp_keepalive_interval=5
iecd.port1.tcp_keepalive_timeout=5
iecd.port1.tcp_keepalive_count=3
iecd.port1.tcp_user_timeout=20000
iecd.port1.master_protocol=iec101
iecd.port1.slave_protocol=iec61850
iecd.port1.ioa_offset=0
iecd.port1.pointmap_file=/root/iecd/iecd_points1.csv
iecd.port1.iec104_local_ip=0.0.0.0
iecd.port1.iec104_local_tcpport=2404
iecd.port1.iec104_k=12
iecd.port1.iec104_w=9
iecd.port1.iec104_t2=10000
iecd.port1.iec104_gi_resp_time=200
iecd.port1.iec104_txq_size=128
iecd.port1.iec104_sync_time=1
iecd.port1.iec104_time_tagged_cmds=0
iecd.port1.iec104_cmd_delay_time=5000
iecd.port1.iec104_fsm_debug_on=0
iecd.port1.iec104_dump_data=0
iecd.port1.iec104_trace_on=0
iecd.port1.iec61850_local_ip=0.0.0.0
iecd.port1.iec61850_local_tcpport=104
iecd.port1.iec101_target_ip=127.0.0.1
iecd.port1.iec101_target_tcpport=999
iecd.port1.iec101_mode=unbalanced
iecd.port1.iec101_cot_tx_length=1
iecd.port1.iec101_cot_source_octet=0
iecd.port1.iec101_asdu_addrln=1
```

```
iecd.port1.iec101_info_obj_addrlen=2
iecd.port1.iec101_data_polling_time=500
iecd.port1.iec101_ack_delay=0
iecd.port1.iec101_link_addrlen=1
iecd.port1.iec101_frame_rsp_time=2000
iecd.port1.iec101_max_tx_retry=3
iecd.port1.iec101_txq_size=128
iecd.port1.iec101_send_spont_delay_acq=1
iecd.port1.iec101_fsm_debug_on=0
iecd.port1.iec101_dump_data=0
iecd.port1.iec101_trace_on=0
iecd.@iec101link[0]=iec101link
iecd.@iec101link[0].portno=1
iecd.@iec101link[0].address=6
iecd.@iec101link[0].asduaddr=6
iecd.@point[0]=point
iecd.@point[0].portno=1
iecd.@point[0].iec61850_id=SENSORS
iecd.@point[0].iec61850_in=LLN0
iecd.@point[0].iec61850_do=SPSS01
iecd.@point[0].iec104_type_id=1
iecd.@point[0].iec104_ioa=5
iecd.@point[0].iec101_type_id=1
iecd.@point[0].iec101_ioa=5
iecd.@point[0].devaddr=1
iecd.@point[0].group=1
iecd.@point[0].index=0
iecd.@point[0].dword=0
iecd.@point[1]=point
iecd.@point[1].portno=1
iecd.@point[1].iec61850_id=SENSORS
iecd.@point[1].iec61850_in=LLN0
iecd.@point[1].iec61850_do=SPSS02
iecd.@point[1].iec104_type_id=1
iecd.@point[1].iec104_ioa=6
iecd.@point[1].iec101_type_id=1
```



```
iecd.@point[1].iec101_ioa=6
iecd.@point[1].devaddr=1
iecd.@point[1].group=1
iecd.@point[1].index=0
iecd.@point[1].dword=0
```

IEC 61850 to IEC 101 Conversion using Package Options

```
root@VA_router:~# uci export iecd package iecd
config iecd 'main'
option enable '1'
config port 'port1'
option enable '1'
option loglevel '5'
option tcp_keepalive_enabled '1'
option tcp_keepalive_interval '5'
option tcp_keepalive_timeout '5'
option tcp_keepalive_count '3'
option tcp_user_timeout '20000' option master_protocol 'iec101' option slave_protocol 'iec61850' option ioa_offset '0'
option pointmap_file '/root/iecd/iecd_points1.csv'
# IEC104 related settings
option iec104_local_ip '0.0.0.0'
option iec104_local_tcpport '2404'
option iec104_k '12'
option iec104_w '9'
option iec104_t2 '10000'
option iec104_gj_resp_time '200'
option iec104_txq_size '128'
option iec104_sync_time '1'
option iec104_time_tagged_cmds '0'
option iec104_cmd_delay_time '5000'
option iec104_fsm_debug_on '0'
```

```
option iec104_dump_data '0'
option iec104_trace_on '0'
# IEC61850 related settings
option iec61850_local_ip '0.0.0.0'
option iec61850_local_tcpport '104'
option iec101_target_ip '127.0.0.1'
option iec101_target_tcpport '999' option iec101_mode 'unbalanced' option iec101_cot_tx_length '1'
option iec101_cot_source_octet '0'
option iec101_asdu_addrlen '1'
option iec101_info_obj_addrlen '2'
option iec101_data_polling_time '500'
option iec101_ack_delay '0'
option iec101_link_addrlen '1'
option iec101_frame_rsp_time '2000'
option iec101_max_tx_retry '3'
option iec101_txq_size '128'
option iec101_send_spont_delay_acq '1'
option iec101_fsm_debug_on '0'
option iec101_dump_data '0'
option iec101_trace_on '0'
# The following section defines IEC101 slave links used in IEC101 unbalanced mode on
# Each link is defined by a config block 'config iec101link'
# To add more links repeat the section block for each added link. To remove links, simply remove the link block from the configuration
# Maximum 32 links are supported #
# Definition of options within the section block:
# portno - port number to which this point belongs (1 to 4) # address - IEC101 slave link address
# asduaddr IEC101 slave common ASDU address
```

```
config iec101link
option portno 1
option address 6
option asduaddr 6
config point
option portno '1'
option iec61850_id 'SENSORS'
option iec61850_in 'LLN0'
option iec61850_do 'SPSS01'
option iec104_type_id '1'
option iec104_ioa '5'
option iec101_type_id 1
option iec101_ioa '5'
option devaddr '1'
option group '1'
option index '0'
option dword '0'
config point
option portno '1'
option iec61850_id 'SENSORS'
option iec61850_in 'LLN0'
option iec61850_do 'SPSS02'
option iec104_type_id '1'
option iec104_ioa '6'
option iec101_type_id 1
option iec101_ioa '6'
option devaddr '1'
option group '1'
option index '0'
option dword '0'
```

44.9. SCADA IEC 104 Gateway Diagnostics

The `iecd` and `tserv` background services are started automatically at router power up. You can manually stop, start or restart these services as follows:

iecd

```

/etc/init.d/iecd stop – stops IECD service
/etc/init.d/iecd start – starts IECD service
/etc/init.d/iecd restart – stops and starts IECD service

```

tservd

```

/etc/init.d/tservd stop – stops TSERVD service
/etc/init.d/ tservd start – starts TSERVD service
/etc/init.d/ tservd restart – stops and starts TSERVD service

```

Events

The diagnosing and protocol tracing on the router the following features are available:

- Viewing syslog events (error messages)
- Running and viewing protocol traces (using syslog)
- Viewing statistic counters and debug information using diagnostic commands

To see the appropriate debug information, you must enable different debug options.

The following table summarizes various options for tracing and diagnostics of the IEC 104 to IEC 101/DNP3/Modbus conversion:

Diagnostic Feature	IEC 104	IEC 101	DNP3	Modbus
Protocol Tracing	option log_severity '7' option iec104_trace_on '1' /etc/init.d/iecd restart logread -f	option log_severity '7' option iec101_trace_on '1' /etc/init.d/iecd restart logread -f	option log_severity '7' option dnp3_trace_on '1' /etc/init.d/iecd restart logread -f	option log_severity '7' option modbus_trace_on '1' /etc/init.d/iecd restart logread -f
Viewing Rx / Tx Hex dump	option log_severity '7' option iec104_dump_data '1' /etc/init.d/iecd restart logread -f	option log_severity '7' option iec101_dump_data '1' /etc/init.d/iecd restart logread -f	option log_severity '7' option dnp3_dump_data '1' /etc/init.d/iecd restart logread -f	option log_severity '7' option modbus_dump_data '1' /etc/init.d/iecd restart logread -f
Viewing Statistics	iecd show stats	iecd show stats	iecd show stats	iecd show stats
Clearing Statistics	iecd clear stats	iecd clear stats	iecd clear stats	iecd clear stats
Viewing debug information	N/a	N/a	N/a	iecd show modbus debug
View point loaded points	iecd show points	iecd show points	iecd show points	iecd show points

Viewing Statistics

To view IEC 104 gateway statistics, enter:

```
root@VA_router:~/iecd# iecd show stats
```

Modbus Stats

```
Modbus DL Frames Rx 20 Tx 3845 TxErrs 0
Modbus DL CRCErrs 0 Bad Addr 0 LengthErrs 0 UnknownPeer 0 SessionClose 0
Modbus App PDU Rx 20 PDU Tx 3845 PDU Rx Errors 0 PDU Rx Exception 0
Modbus App PDU Rx Timeout 3825 Unknown DevAddr 0 Rx Unexpected FC 0
Modbus App PDU TxQ Overrun 0
```

IEC104 Stats

```
IEC104 DL state: CLOSED
IEC104 DL uptime: 0 hrs 0 mins 0 secs
IEC104 DL PktsRx 15 PktsTx 21 TxQ Overrun 0
IEC104 App ASDU Rx 6 ASDU Tx 12 Bad ASDU 0
```

Viewing Point Mappings

To view IEC 104 gateway point mappings, enter:

```
root@VA_router:~/iecd# iec show points
==== IEC104 point map: ====
IEC 104 Types Legend:
-----
SPI: Single point information (1 bit)
DPI: Double point information (2 bit)
MVA: Measured normalized value (16 bit signed)
MVAFP: Measured value, floating point number (32 bit signed)
SVA: Measured scaled value (16 bit signed)
BSTR32: Bitstring of 32 bits
IT: Integrated Total (Counter 32 bit)
CP24: with 3 octet time tag CP24Time2a
CP56: with 7 octet time tag CP56Time2a
NQD: Without quality descriptor
-----
(#1) IOA=64213, Val=0x00000000, IEC104Typeld=30 (SPI-CP56) DevAddr 1 Modbus pt 1, Type 0 (Discreet Input (1bit))
(#2) IOA=64214, Val=0x00000000, IEC104Typeld=30 (SPI-CP56) DevAddr 1 Modbus pt 2, Type 0 (Discreet Input (1bit))
(#3) IOA=64215, Val=0x00000000, IEC104Typeld=30 (SPI-CP56) DevAddr 1 Modbus pt 9, Type 0 (Discreet Input (1bit))
(#4) IOA=64216, Val=0x00000000, IEC104Typeld=30 (SPI-CP56) DevAddr 1 Modbus pt 10, Type 0 (Discreet Input (1bit))
(#5) IOA=64217, Val=0x00000000, IEC104Typeld=34 (MVA-CP56) DevAddr 1 Modbus pt 2, Type 1 (Input Register (16 bit))
(#6) IOA=64218, Val=0x00000000, IEC104Typeld=34 (MVA-CP56) DevAddr 1 Modbus pt 7, Type 1 (Input Register (16 bit))
(#7) IOA=64219, Val=0x00000000, IEC104Typeld=34 (MVA-CP56) DevAddr 1 Modbus pt 1, Type 2 (Holding Register (16 bit))
```

45. DNP3 Outstation Application

Merlin routers have a feature that allows the router to operate as a DNP3 outstation application. A DNP3 SCADA master can poll the router and obtain the following information:

- Router uptime in seconds.
- The serial number of the router.
- The status of up to two router interfaces.

Configuration Packages Used

Package	Sections
dnpsd	dnpsd

45.1. Configuring DNP3 Outstation Using The Web Interface

To configure the DNP3 outstation, from the top menu select **Services -> DNP3 Outstation**.

Check the **Enable** box and fill in your unique parameters.

The router listens for inbound UDP connections from the SCADA master on the specified port.

The web automatically names the `dnpsd` config section 'main'.

DNP3 Outstation

Configuration of the DNP3 Outstation Daemon

Settings

Enable

Local DNP Address

Master DNP Address

Master IP Address

Local Port Local udp port to listen to incoming DNP requests

Monitor Interface1 Name of first interface to monitor and report status

Monitor Interface2 Name of second interface to monitor and report status

DNP3 outstation settings

Web Field/UCI/Package Option	Description				
Web: Enable UCI: dnposd.main.enabled Opt: enabled	Enables the DNP3 outstation application on the router. <table border="1"> <tr> <td>Default: 0</td> <td>Disabled</td> </tr> <tr> <td>1</td> <td>Enabled</td> </tr> </table>	Default: 0	Disabled	1	Enabled
Default: 0	Disabled				
1	Enabled				
Web: Local DNP Address UCI: dnposd.main.local_address Opt: local_address	Defines the DNP3 address of the router. <table border="1"> <tr> <td>Default:</td> <td>Blank</td> </tr> <tr> <td>Range</td> <td>0-65535</td> </tr> </table>	Default:	Blank	Range	0-65535
Default:	Blank				
Range	0-65535				
Web: Master DNP Address UCI: dnposd.main.master_address Opt: master_address	Defines the DNP3 address of the SCADA master. <table border="1"> <tr> <td>Default:</td> <td>Blank</td> </tr> <tr> <td>Range</td> <td>0-65535</td> </tr> </table>	Default:	Blank	Range	0-65535
Default:	Blank				
Range	0-65535				
Web: Master IP Address UCI: dnposd.main.master_host Opt: master_host	Defines the IP address of the SCADA master. Only requests from this host will be processed.				
Web: Local Port UCI: dnposd.main.local_port Opt: local_port	Defines the UDP port for the router to listen on for incoming DNP3 messages from the SCADA master. <table border="1"> <tr> <td>Default:</td> <td>20000</td> </tr> <tr> <td>Range</td> <td>0-65535</td> </tr> </table>	Default:	20000	Range	0-65535
Default:	20000				
Range	0-65535				
Web: Monitor Interface1 UCI: dnposd.main.monitor_if1 Opt: monitor_if1	Defines the first interface to monitor for status. <p>Note: the interface names need to exactly match to the physical names. You can view the physical name by using the ifconfig command via command line.</p> <table border="1"> <tr> <td>Default:</td> <td>Blank</td> </tr> <tr> <td>Range</td> <td>0-65535</td> </tr> </table>	Default:	Blank	Range	0-65535
Default:	Blank				
Range	0-65535				
Web: Monitor Interface2 UCI: dnposd.main.monitor_if2 Opt: monitor_if2	Defines the second interface to monitor for status. <p>Note: the interface names need to exactly match to the physical names. You can view the physical name by using the ifconfig command via command line.</p> <table border="1"> <tr> <td>Default:</td> <td>Blank</td> </tr> <tr> <td>Range</td> <td>0-65535</td> </tr> </table>	Default:	Blank	Range	0-65535
Default:	Blank				
Range	0-65535				

45.2. Configuring DNP3 Outstation Using Command Line

DNP3 outstation is configured under the dnposd package /etc/config/dnp3osd

DNP3 Outstation using UCI

```
root@VA_router:~# uci show dnpsd
dnpsd.main=dnpsd
dnpsd.main.local_port=20000
dnpsd.main.enabled=yes
dnpsd.main.local_address=1
dnpsd.main.master_address=2
dnpsd.main.master_host=10.1.10.21
dnpsd.main.monitor_if1=wwan0
dnpsd.main.monitor_if2=pppoe-DSL
```

Modify these commands by running a `uci set <parameter>` command followed by `uci commit`.

DNP3 Outstation using Package Options

```
root@VA_router:~# uci export dnpsd
package dnpsd
config dnpsd 'main'
option local_port '20000'
option enabled 'yes'
option local_address '1'
option master_address '2'
option master_host '10.1.10.21'
option monitor_if1 'wwan0'
option monitor_if2 'pppoe-DSL'
```

45.3. DNP3 Outstation Diagnostics

Restarting dnpsd

To restart dnpsd service, enter:

```
root@VA_router:~# /etc/init.d/dnpsd restart
```

Tracing DNP3 Packets

By default, the DNP3 outstation listens on UDP port 20000. To trace UDP packets on port 20000, enter:

```
root@VA_router:~# tcpdump -i any -n udp -p port 20000 &
tcpdump: verbose output suppressed, use -v or -vv for full protocol decode
listening on any, link-type LINUX_SLL (Linux cooked), capture size 65535 bytes
```

To stop tracing, enter `fg` to bring tracing task to foreground, and then **<CTRL-C>** to stop the trace.

```
root@VA_router:~# fg
tcpdump -i any -n udp -p port 20000
^C
33 packets captured
33 packets received by filter
0 packets dropped by kernel
```

46. Serial Interface

Many different applications and device drivers use the serial interface. You configure the serial interface using the relevant application; for example Terminal Server; therefore there is no standalone serial configuration page. You can monitor the various serial interfaces using either the command line or the web interface.

46.1. Monitoring Serial Interfaces Using The Web Interface

In the top menu, select **Status -> Serial Interfaces**. Depending on the number of serial interfaces present on the device, a number of tabs will appear giving access to information about each interface. The information presented will also depend on the actual type of the serial interface.

Serial Statistics

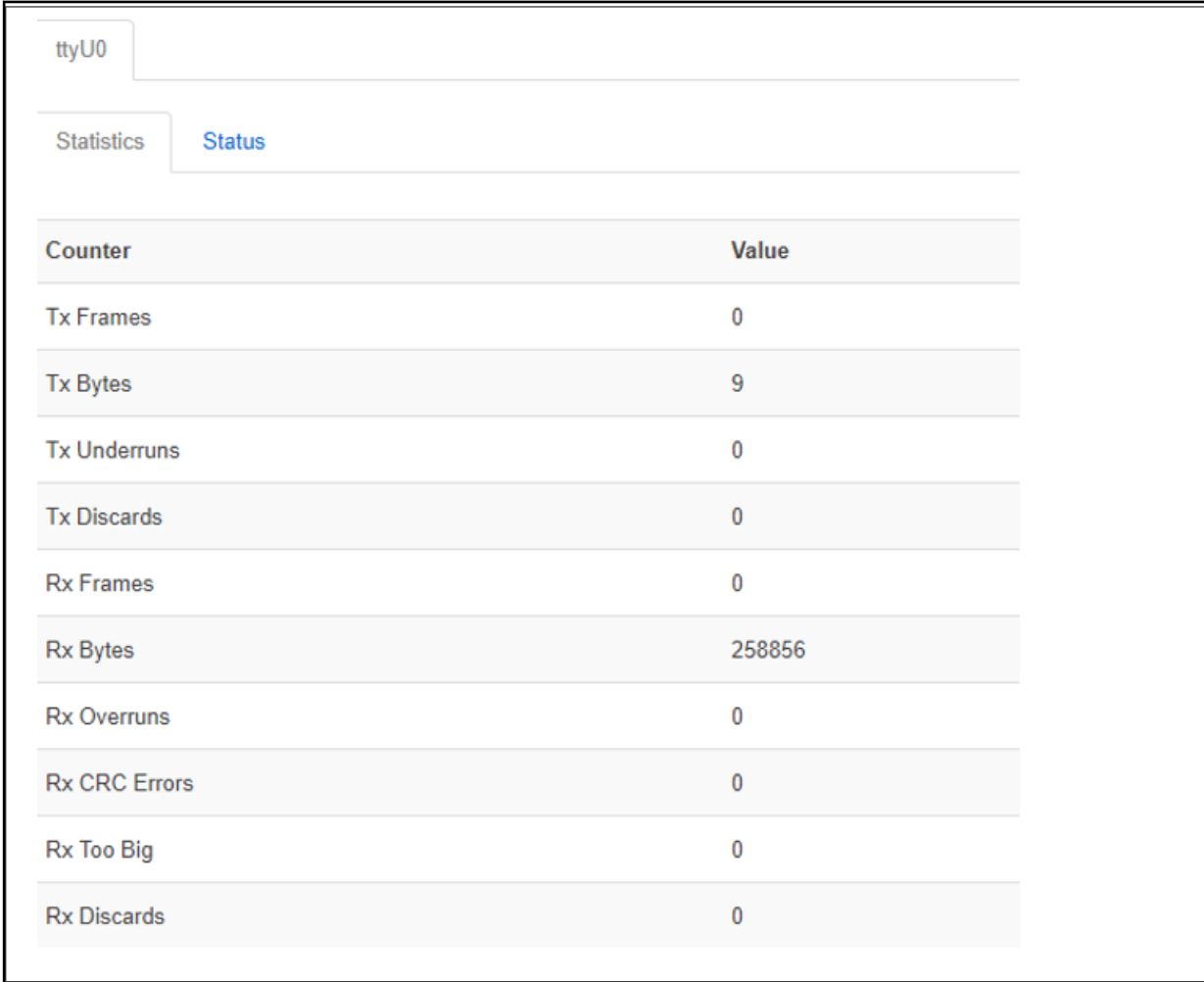

Counter	Value
Tx Frames	0
Tx Bytes	9
Tx Underruns	0
Tx Discards	0
Rx Frames	0
Rx Bytes	258856
Rx Overruns	0
Rx CRC Errors	0
Rx Too Big	0
Rx Discards	0

The serial statistics page for serial-0

ttyU0	
Statistics	Status
Cable Id	V.24 DTE
Hardware Version	QD3128B
Firmware Version	1.3.15
DAC Voltage	1650000uV
DTR	1
DSR	1
RTS	1
DCD	0

The serial status page for serial-0

46.2. Set Options For Automatically Created Interfaces (Failover)

In the top menu on the web interface page, select **Services -> Mobile Manager**. The Mobile Manager page appears.

There are five sections in the mobile manager page:

Section	Description
Basic settings	Enable SMS, configure SIM pin code, select roaming SIM, collect ICCIDs and set IMSI.
Advanced	Configure advanced options such as collect ICCIDs and temperature polling interval.
CDMA*	CDMA configuration
Callers	Configure callers that can use SMS.
Roaming Interface Template	Configure Preferred Roaming List options.
*Option available only for Telit CE910-SL module.	

46.3. Monitoring Serial Interfaces Using Command Line

Serial Statistics using Command Line

To view serial statistics, enter:

```
root@VirtualAccess:~# serial_stats
ttyU0 statistics
Tx Frames      0
Tx Bytes      9
Tx Underruns   0
Tx Discards   0
Rx Frames      0
Rx Bytes     258856
Rx Overruns   0
Rx CRC Errors 0
Rx Too Big    0
Rx Discards   0
```

Serial Status using Command Line

To view serial statistics, enter:

```
root@VirtualAccess:~# serial_status
ttyU0 status
Cable Id V.24 DTE
Hardware Version QD3128B
Firmware Version 1.3.15
DAC Voltage 1650000uV
DTR 1
DSR 1
RTS 1
DCD 0
```

Resetting Serial Statistics

To reset serial statistics, enter:

```
root@VirtualAccess:~# serial_stats_reset ttyU0
Serial interface statistics reset
```

You can reset statistics for all or individual serial interfaces.

WESTERMO

Westermo • Metallverksgatan 6, SE-721 30 Västerås, Sweden

Tel +46 16 42 80 00 Fax +46 16 42 80 01

E-mail: info@westermo.com

www.westermo.com