



Lynx DSS L205-S1-EX

Industrial Ethernet 5-port Device Server Switch



General information

Legal information

The contents of this document are provided “as is”. Except as required by applicable law, no warranties of any kind are made in relation to the accuracy and reliability or contents of this document, either expressed or implied, including but not limited to the implied warranties of merchantability and fitness for a particular purpose. Westermo reserves the right to revise this document or withdraw it at any time without prior notice.

Under no circumstances shall Westermo be responsible for any loss of data or income or any special, incidental, and consequential or indirect damages howsoever caused.

More information about Westermo can be found at www.westermo.com

Software tools

Related software tools are available at www.westermo.com/support/software-tools.

License and copyright for included Free/Libre Open Source Software

This product includes software developed by third parties, including Free/Libre Open Source Software (FLOSS). The specific license terms and copyright associated with the software are included in each software package respectively. Please visit the product web page for more information.

Upon request, the applicable source code will be provided. A nominal fee may be charged to cover shipping and media. Please direct any source code request to your normal sales or support channel.





WeOS Management Guide

This product runs WeOS (Westermo Operation System). Instructions for quick start, configuration, factory reset and use of USB port are found in the WeOS Management Guide at www.westermo.com.

Safety and Regulations

Warning signs are provided to prevent personal injuries and/or damages to the product.

The following levels are used:

Level of warning	Description	Consequence personal injury	Consequence material damage
 WARNING	Indicates a potentially hazardous situation	Possible death or major injury	Major damage to the product
 CAUTION	Indicates a potentially hazardous situation	Minor or moderate injury	Moderate damage to the product
 NOTICE	Provides information in order to avoid misuse of the product, confusion or misunderstanding	No personal injury	Minor damage to the product
 NOTE	Used for highlighting general, but important information	No personal injury	Minor damage to the product

Before installation:

Read this manual completely and gather all information on the product. Make sure that you understand it fully. Check that your application does not exceed the safe operating specifications for this product.



WARNING - SAFETY DURING INSTALLATION

The product must be installed by qualified service personnel and built in to an apparatus cabinet or similar, where access is restricted to service personnel only.

During installation, ensure a protective earthing conductor is first connected to the protective earthing terminal (only valid for metallic housings). Westermo recommends a cross-sectional area of at least 4 mm².

If the product does not have a protective earthing terminal, then the DINrail must be connected to protective earth. Upon removal of the product, ensure that the protective earthing conductor, or the connection to earth via the DIN-rail, is disconnected last.



WARNING - HAZARDOUS VOLTAGE

Do not open an energized product. Hazardous voltage may occur when connected to a power supply.



WARNING - PROTECTIVE FUSE

It must be possible to disconnect manually from the power supply. Ensure compliance to national installation regulations.

Replacing the internal fuse must only be performed by Westermo qualified personell.



WARNING - POWER SUPPLY CONNECTION

There are safety regulations on which power sources that shall be used in conjunction with the product. Refer to Interface Specifications.



WARNING - REDUCE THE RISK OF FIRE

To reduce the risk of fire, use only telecommunication line cords with a cable diameter of AWG 26 or larger. Regarding power cable dimensions, see Interface Specifications.



CAUTION - CORROSIVE GASES

If the product is placed in a corrosive environment, it is important that all unused connector sockets are protected with a suitable plug, in order to avoid corrosion attacks on the gold plated connector pins.



CAUTION - ELECTROSTATIC DISCHARGE (ESD)

Prevent electrostatic discharge damages to internal electronic parts by discharging your body to a grounding point (e.g. use a wrist strap).



CAUTION - HOT SURFACE

Be aware of that the surface of this product may become hot. When it is operated at high temperatures, the external surface may exceed Touch Temperature Limit according to the product's relevant electrical safety standard.



CAUTION - CABLE TEMPERATURE RATING FOR FIELD TERMINAL WIRES

There may be a requirement on the minimum temperature rating of the cable to be connected to the field wiring terminals, see Interface Specifications.

Care recommendations

Follow the care recommendations below to maintain full operation of product and to fulfill the warranty obligations:

- Do not drop, knock or shake the product. Rough handling above the specification may cause damage to internal circuit boards.
- Use a dry or slightly water-damp cloth to clean the product. Do not use harsh chemicals, cleaning solvents or strong detergents.
- Do not paint the product. Paint can clog the product and prevent proper operation.

If the product is used in a manner not according to specification, the protection provided by the equipment may be impaired.

If the product is not working properly, contact the place of purchase, nearest Westermo distributor office or Westermo technical support.

Product disposal



This symbol means that the product shall not be treated as unsorted municipal waste when disposing of it. It needs to be handed over to an applicable collection point for recycling electrical and electronic equipment.

By ensuring this product is disposed of correctly, you will help to reduce hazardous substances and prevent potential negative consequences to both environment and human health, which could be caused by inappropriate disposal.



ATEX certification number

Baseefa12ATEX0119X

Standards

EN 60079-0, EN 60079-15

Certification code

Ex nA IIC T3 Gc (-40°C ≤ Ta ≤ +70°C)

ATEX code

 II 3G

Specific Conditions of Use

The equipment must be installed in an area of not more than pollution degree 2 in accordance with IEC/EN 60664-1, and in an enclosure that provides a minimum degree of protection of at least IP54 and complies with the relevant requirements of EN 60079-0 and EN 60079-15.

All external connections to the equipment and, where applicable, the SFP modules must not be inserted or removed unless either the area in which the equipment is installed is known to be non-hazardous, or the circuits connected have been de-energized.

The network cables once installed must be properly fixated by the use of cable ties or similar to reduce the risk of accidentally withdrawing the plugs.

Equipment input parameters

Power Connector: +DC1, +DC2 & -COM

Working Voltage Range = 24 V to 48 VDC.

I/O Connector: 'Status +' & 'Status -' and 'Digital in +' and 'Digital in -'

Maximum I/P Voltage = 60 VDC.



ATEX-Zulassungsnummer

Baseefa12ATEX0119X

Standards

EN 60079-0, EN 60079-15

Zertifizierungscode

Ex nA IIC T3 Gc ($-40\text{ °C} \leq T_a \leq +70\text{ °C}$)

ATEX-Code

 II 3G

Spezifische Einsatzbedingungen

Die Geräte müssen in einem Bereich welcher einem maximalen Verschmutzungsgrad der Stufe 2 gemäß IEC/EN 60664-1 entspricht und in einem Gehäuse, das einen Schutzgrad von mindestens IP54 bietet und die relevanten Anforderungen von N 60079-0 und EN 60079-15 erfüllt, installiert werden.

Alle äußeren Anschlüsse des Gerätes und auch die SFP-Module dürfen nur dann verbunden oder getrennt werden, wenn entweder der Bereich, in dem das Gerät installiert ist, nachweislich ungefährlich ist, oder die verbundenen Stromkreise spannungsfrei sind.

Die Netzkabel müssen nach der Installation mithilfe von Kabelbindern oder ähnlichem Material ordnungsgemäß befestigt werden, um ein versehentliches Abziehen der Stecker zu verhindern.

Eingangsparameter der Geräte

Stromversorgung: +DC1, +DC2 & -COM

Betriebsspannungsbereich = 24 V to 48 VDC.

I/O-Anschluss: 'Status +' & 'Status -' und 'Digital in +' und 'Digital in -'

Maximale I/P-Spannung = 60 VDC.



Numéro de certification ATEX

Baseefa12ATEX0119X

Normes

EN 60079-0, EN 60079-15

Code de certification

Ex nA IIC T3 Gc (-40°C ≤ Ta ≤ +70°C)

Code ATEX

 II 3G

Conditions spéciales d'utilisation

L'équipement doit être installé dans une zone où le degré de pollution ne dépasse pas le degré 2 conformément à l'IEC/EN 60664-1, et dans un boîtier qui fournit un niveau de protection au moins égal à IP54 et conforme aux exigences applicables à EN 60079-0 et EN 60079-15

Toutes les connexions externes à l'équipement et, le cas échéant, les modules SFP ne doivent pas être insérés ou retirés sauf si la zone dans laquelle l'équipement est installé est reconnue comme non dangereuse, ou si les circuits raccordés sont hors-tension.

Une fois les câbles réseau installés, ils doivent être correctement fixés grâce à des attaches de câbles ou autre élément semblable afin de réduire le risque de débranchement accidentel.

Paramètres d'entrée des équipements

Connecteur d'alimentation : +DC1, +DC2 & -COM

Double entrée d'alimentation 24 V à 48 VCC

Connecteur E/S : « Statut + » et « Statut - » et « Entrée digitale + » et « Entrée digitale - »

Tension maximale I/P = 60 VCC.

Agency approvals and standards compliance

Type	Approval / Compliance
EMC	EN 61000-6-1, Immproducty residential environments
	EN 61000-6-2, Immproducty industrial environments
	EN 61000-6-3, Emission residential environments
	EN 61000-6-4, Emission industrial environments
	EN 50121-4, Railway signalling and telecommunications apparatus
	IEC 62236-4, Railway signalling and telecommunications apparatus
Safety	UL 62368-1, Safety Communication Technology
Marine	DNV GL rules for classification - Ships and offshore products .
Ex	EN 60079-0 and EN 60079-15

UL 62368-1

Notice:

This product has been tested and found compliant to UL 62368-1, Safety for Communication Technology. In accordance with the definitions of the standard, this product shall be handled by instructed personell. Energy source classifications are according to following:

Electrical energy source	Power port	ES1
	Serial port	ES1
	Ethernet port	ES1, TNV-1
	I/O port	ES1
Power source	Power port	PS3
Thermal energy source	Enclosure	TS1
Mechanical energy source	Enclosure	MS1
Radiation energy source	SFP	RS1

FCC Part 15.105

Notice:

This equipment has been tested and found to comply with the limits for a Class B digital device, pursuant to Part 15 of the FCC Rules. These limits are designed to provide reasonable protection against harmful interference in a residential installation. This equipment generates, uses and can radiate radio frequency energy and, if not installed and used in accordance with the instructions, may cause harmful interference to radio communications. However, there is no guarantee that interference will not occur in a particular installation. If this equipment does cause harmful interference to radio or television reception, which can be determined by turning the equipment off and on, the user is encouraged to try to correct the interference by one or more of the following measures:

- ⌘ Reorient or relocate the receiving antenna
- ⌘ Increase the separation between the equipment and receiver
- ⌘ Connect the equipment into an outlet on a circuit different from that to which the receiver is connected
- ⌘ Consult the dealer or an experienced radio/TV technician for help.

Corrosive environment

Notice:

This product has been successfully tested in a corrosion test according to *IEC 60068-2-60, method 3*. This means that the product meets the requirements to be placed in an environment classified as *ISA-S71.04 class G3*.



CAUTION - CORROSIVE GASES

If the product is placed in a corrosive environment, it is important that all unused connector sockets are protected with a suitable plug, in order to avoid corrosion attacks on the gold plated connector pins.

Declaration of Conformity

Hereby, Westermo declares that this product is in compliance with applicable EU directives. The full EU declaration of conformity and other detailed information is available at www.westermo.com/support/product-support.

Product Description

L205-S1-EX is an industrial switch and device server made for harsh environments. WeOS is the operating system of L205-S1 enabling the product to operate in two functional levels. The switch can be used in either 10 or 100 Mbit networks. L205-S1-EX has one serial port that supports RS-232.

Our unique FRNT (Fast Recovery of Network Topology) technology is the fastest protocol on the market to re-configure a network in the event of any link or hardware failure. That is why our products are used in safety critical applications such as tunnels, traffic signal control and railway systems.

Hardware Overview

Location of interface ports and LEDs

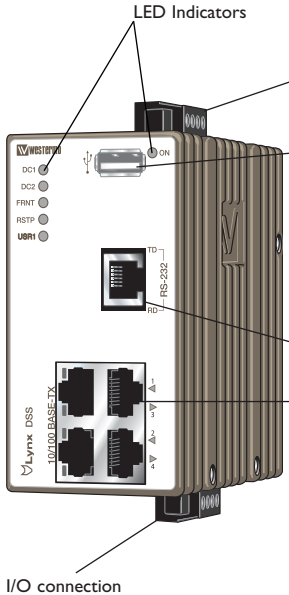

USB

Position	Direction* / description	Output values
1	Out / VBUS	$U_{out} = 5 \text{ VDC max}$ $I_{out} = 400 \text{ mA max}$
2	In/out / D-	
3	In/out / D+	
4	GND	
Shield	PE	

RS-232

Position	Signal	Direction	Description	Input/output values
No.1	DSR	Out	Data Set Ready	$U = \pm 12 \text{ V max}$ $I = \pm 60 \text{ mA max}$ Data rate: 50 bit/s - 115.2 kbit/s
No. 2	DCD	Out	Data Carrier Detect	
No. 3	DTR	In	Data Terminal Ready	
No. 4	SG	-	Signal Ground, not chassis ground	
No. 5	RD	Out	Receive Data	
No. 6	TD	In	Transmit Data	
No. 7	CTS	Out	Clear To Send	
No. 8	RTS	In	Request To Send	

Ethernet connection TX (4 ports)

Position	Signal	Direction	Description	Input/output values
No.1	TD+	In/Out	Transmitted/Received data	Per port: $U = \pm 1 \text{ V (4V/\mu s)}$ $I = \pm 20 \text{ mA}$ Data rate: 10/100 Mbit/s
No. 2	TD-	In/Out	Transmitted/Received data	
No. 3	RD+	In/Out	Transmitted/Received data	
No. 4	-		Not Connected	
No. 5	-		Not Connected	
No. 6	RD-	In/Out	Transmitted/Received data	
No. 7	-		Not Connected	
No. 8	-		Not Connected	
Shield			Connected to PE	

Galvanically isolated via signal transformers and capacitively isolated to GND/PE through a 2kV 1000pF capacitor.

RJ-45 connector (Front view)

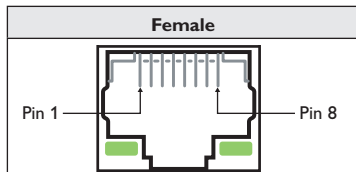
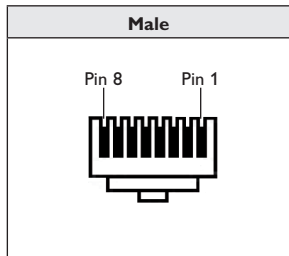

Interface specifications

Power	
Operating voltage	Rated: 24 to 48 VDC Operating: 19 to 60 VDC
Rated current	140 mA (290 mA) @ 24 VDC (with 500 mA USB load) 70 mA (140 mA) @ 48 VDC (with 500 mA USB load)
Rated frequency	DC
Inrush current, I ² t	22.7·10 ⁻³ A ² s @ 48 VDC
Startup current*	2 x Rated current
Polarity	Reverse polarity protected
Redundant power input	Yes
Isolation to	All other ports
Connection	Detachable screw terminal
Conductor cross section	0.2 - 2.5 mm ² (AWG 24 - 12)
Stripping length cable	7 mm
Tightening torque, terminal screw	0.5 -0.6 Nm
Tightening torque, screw flange	0.3 Nm
Shielded cable	Not required

* Recommended external supply current capability for proper start-up

Ethernet TX	
Electrical specification	IEEE std 802.3
Data rate	10 Mbit/s, 100 Mbit/s, manual or auto
Duplex	Full or half, manual or auto
Circuit type	TNV-1
Transmission range	Up to 150 m with CAT5e cable or better*
Isolation to	All other ports
Connection	RJ-45, auto MDI/MDI-X
Cabling	Shielded CAT5e or better is recommended
Conductive housing	Yes
Number of ports	4

* Refer to Safety section.

RS-232	
Electrical specification	EIA RS-232
Data rate	50 bit/s - 115.2 kbit/s
Data format	7 or 8 data bits, Odd, even or none parity, 1 or 2 stop bits
Protocol	Transparent, optimised by packing algorithm
Circuit type	SELV
Transmission range	15 m / 49 ft
Isolation to	All other ports
Connection	RJ-45 according to EIA-561
Shielded cable	Recommended
Conductive housing	Yes
Number of ports	1

I/O / Relay output	
Maximum voltage/current	60 VDC / 80 mA
Contact resistance	Max 30 Ω
Isolation to	All other ports
Connection	Detachable screw terminal
Conductor cross section	0.14 - 1.5 mm ² (AWG 28 - 16)
Stripping length cable	7 mm
Tightening torque, terminal screw	0.22 -0.25 Nm
Tightening torque, screw flange	0.3 Nm

I/O / Digital input	
Maximum voltage/load current	60 VDC / 2 mA
Voltage levels	Logic one: >12V Logic zero: <1V
Isolation to	All other ports
Connection	Detachable screw terminal
Conductor cross section	0.14 - 1.5 mm ² (AWG 28 - 16)
Stripping length cable	7 mm
Tightening torque, terminal screw	0.22 -0.25 Nm
Tightening torque, screw flange	0.3 Nm

USB	
Electrical specification	USB 2.0 host interface
Data rate	Up to 12 Mbit/s (full-speed mode)
Circuit type	SELV
Maximum supply current	400 mA
Connection	USB receptacle connector type A

Console	
Electrical specification	LVTTTL/LVCMOS-level
Data rate	115.2 kbit/s
Data format	8 data bits, no parity, 1 stop bit, no flow control
Circuit type	SELV
Connection	2.5 mm jack, use only Westermo cable 1211-2027

Type tests and environmental conditions

Environmental phenomena	Basic standard	Description	Test levels
Electrostatic discharge	EN 61000-4-2	Enclosure	Contact: ± 6 kV Air: ± 8 kV
Fast transients	EN 61000-4-4	Power port	± 2 kV
		Ethernet	
		Status out/Digital in	
		Serial ports	
Surge	EN 61000-4-5	Power port	L-E: ± 2 kV, 42Ω , $0.5 \mu\text{F}$, $1.2/50 \mu\text{s}$ L-L: ± 2 kV, 42Ω , $0.5 \mu\text{F}$, $1.2/50 \mu\text{s}$ L-E: ± 2 kV, 12Ω , $9 \mu\text{F}$, $1.2/50 \mu\text{s}$ L-L: ± 1 kV, 2Ω , $18 \mu\text{F}$, $1.2/50 \mu\text{s}$
		Ethernet	L-E: ± 2 kV, 20Ω , $0.5 \mu\text{F}$, $1.2/50 \mu\text{s}$
		Status out/Digital in	L-E: ± 2 kV, 42Ω , $0.5 \mu\text{F}$ L-L: ± 1 kV, 42Ω , $0.5 \mu\text{F}$
		RS-232	L-E: ± 2 kV, 2Ω , $0.5 \mu\text{F}$
Power frequency magnetic field	EN 61000-4-8	Enclosure	300 A/m; 0, 16.7, 60 Hz 1000 A/m; 50 Hz
Pulsed magnetic field	EN 61000-4-9	Enclosure	300 A/m
Radiated RF immunity	EN 61000-4-3	Enclosure	20 V/m @ (80 - 2700) MHz 10 V/m @ (2.7 - 6) GHz 1 kHz sine, 80% AM
Conducted RF immunity	EN 61000-4-6	Power port	10 V, 80% AM, 1 kHz; (0.15 - 80) MHz
		Ethernet	
		Status out/Digital in	
		Serial ports	
		Earth port	
Radiated RF emission	CISPR 16-2-3 ANSI C63.4	Enclosure	Class B (Residential), 30 MHz to 6 GHz FCC Part 15 B, Class B, 30 MHz to 6.5 GHz
Conducted RF emission	CISPR 16-2-1 ANSI C63.4	Power port	Class B
		Ethernet	Class B
Dielectric strength	UL 62368-1	Power port to all other ports	1.5 kVrms, 50 Hz, 1 min
		Ethernet ports to all other ports	
		RS-232 port to all other ports	

Environmental			
Temperatures	EN 60068-2-1 EN 60068-2-2	Operating	-40 to +70°C (-40 to +158°F)*
		Storage and transport	-50 to +85°C (-58 to +185°F)
Humidity	EN 60068-2-30	Operating	5 to 95 % relative humidity
		Storage and transport	
Altitude		Operating	2 000 m/70 kPa
MTBF	MIL-C217F2, Parts count	Ground Benign, 25°C (77°F)	677 000 hours
Service life		Operating	10 year
Vibration	IEC 60068-2-6 (sine)	Operating	3 - 13.2 Hz: 1mm 13.2 - 100 Hz: 0.7 g 5.5 - 30 Hz: 1.5 g 30 - 50 Hz: 0.42 mm 50 - 500 Hz: 4.2 g**
	IEC 60068-2-64 (random)		5 - 20 Hz: 2 m ² /s ² , 20 - 2000 Hz: - 3 dB/oct
Shock	IEC 60068-2-27	Operating	30 g, 11 ms 100 g, 6 ms**
Bump	IEC 60068-2-27	Operating	10 g, 11 ms, x1000
Packaging			
Enclosure	UL 62368-1	Zinc	Fire enclosure
Dimension W x H x D With connectors			52.5 x 100 x 101 mm 52.5 x 119 x 101 mm
Weight			0.7 kg
Degree of protection	EN 60529	Enclosure	IP 40
Cooling			Convection

* Refer to "Safety" section in User Guide.

** Might require Ethernet cables to be fastened close to the product.

Console Port

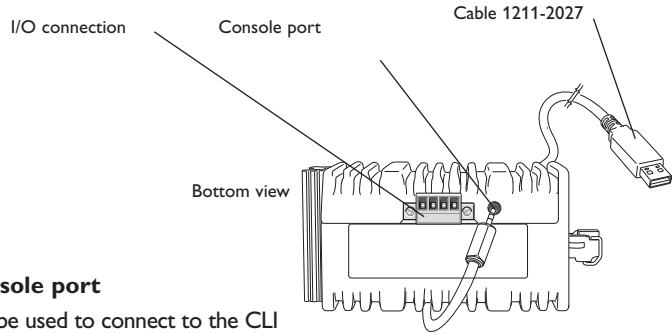

Connection to console port

The console port can be used to connect to the CLI (Command Line Interface).

The following steps needs to be taken

1. Connect the serial diagnostic cable to the console port (use only Westermo cable 1211-2027).
2. Connect cable to your computer (USB port, if drivers are needed they can be downloaded from our Web page).
3. Use a terminal emulator and connect with correct speed and format (115200, 8N1) to the assigned port.

For more information about the CLI, see the WeOS management guide.

Accessories	
Description	Art no
Westermo console cable	1211-2027
RJ45 to terminal block	1200-2490
RJ45 to DB9 cable	1211-2210

Connector Information

Power connection

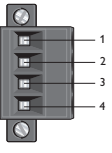
	4-position	Product marking	Direction	Description	Input values
	No. 1	+DC1	Input	Supply voltage input DC1	$U_{in} = (19 - 60) \text{ VDC}$ $I_{in} = 290 \text{ mA @ } 24 \text{ VDC}$ $P_{in} = 7 \text{ W @ } 24 \text{ VDC}$
	No. 2	+DC2	Input	Supply voltage input DC2	
	No. 3	-COM	Input	Common	
	No. 4	-COM	Input	Common	

Lynx supports redundant power connection. The positive inputs are +DC1 and +DC2, the negative input for both supplies are -COM. Connect the primary voltage (e.g. +24 VDC) to the +DC1 pin and return to one of the -COM pins on the power input.

I/O connection

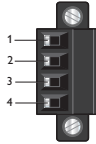
	4-position	Product marking	Direction	Description	Input / Output values
	No. 1	Status +	Output	Alarm relay (status) contact	$U_{in} = 60 \text{ VDC max}$
	No. 2	Status -	Output	Alarm relay (status) contact	$I_{in} = 80 \text{ mA max}$
	No. 3	Digital in +	Input	Digital in +	$U_{in} = 60 \text{ VDC max}$
	No. 4	Digital in -	Input	Digital in -	$I_{in} = 2 \text{ mA max}$

The Status output is a potential free, opto-isolated normally closed solid-state relay. This can be configured to monitor various alarm events within the Lynx product, see WeOS Management Guide. An external load in series with an external voltage source is required for proper functionality. For voltage/current ratings, see Interface Specification section.

Console port

Position	Direction* / description	Input/output values
No.1	In / out / GND	$U = 3.3 \text{ VDC max}$ $I = 24 \text{ mA max}$
No. 2	Out / Tx	
No. 3	In / Rx	

* Direction relative to this product.

The Digital in is an opto-isolated digital input which can be used to monitor external events. For voltage/current ratings, see Interface Specification section:

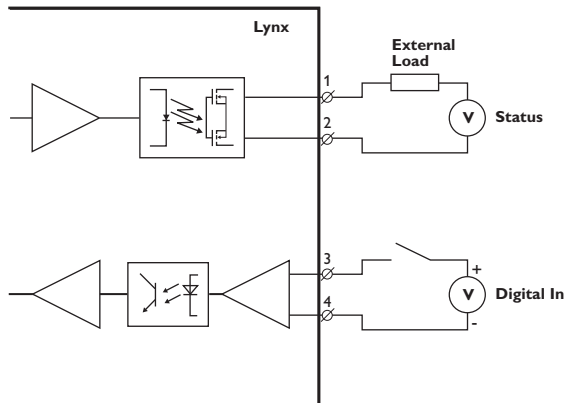

LED indicators

LED	Status	Description
ON	OFF	Product has no power.
	GREEN	All OK, no alarm condition.
	RED	Alarm condition, or until product has started up. (Alarm conditions are configurable, see "WeOS Management Guide").
	BLINK	Location indicator ("Here I am!"). Activated when connected to IPConfig Tool, or upon request from Web or CLI.
DC1	OFF	Product has no power
	GREEN	Voltage present on DC1*
	RED	No voltage present on DC1
DC2	OFF	Product has no power
	GREEN	Voltage present on DC2*
	RED	No voltage present on DC2.
FRNT	OFF	FRNT disabled.
	GREEN	FRNT OK.
	RED	FRNT Error.
	BLINK	Product configured as FRNT Focal Point.
RSTP	OFF	RSTP disabled.
	GREEN	RSTP enabled.
	BLINK	Product elected as RSTP/STP root switch.
USR1	OFF	
	GREEN	Configurable, see WeOS Management Guide.
	RED	
Rx/TD, TD	OFF	No serial data received.
	GREEN FLASH	Serial data received.
Tx/RD, RD	OFF	No serial data transmitted.
	GREEN FLASH	Serial data transmitted.
1 to 4	OFF	No Link.
	GREEN	Link established.
	GREEN FLASH	Data traffic indication.
	YELLOW	Port alarm and no link. Or if FRNT or RSTP mode, port is blocked.

*Note: Supply voltage levels must be ensured externally. A green LED may not guarantee a valid operating voltage level.

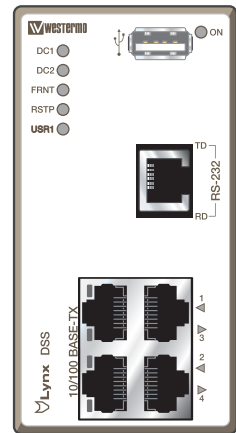

Mounting

This product should be mounted on 35 mm DIN-rail, which is horizontally mounted inside an apparatus cabinet or similar. It is recommended that the DIN-rail is connected to ground. Snap on the product to the DIN-rail according to the figure.

Mounting Lynx with integrated DIN-clip:

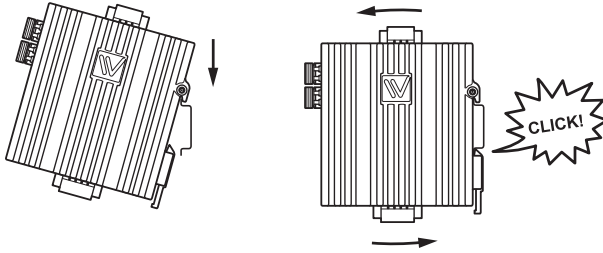

Removal

This product has an integrated DIN-clip. To remove the product, press down the support at the back with a screwdriver and lift it off the DIN-rail.

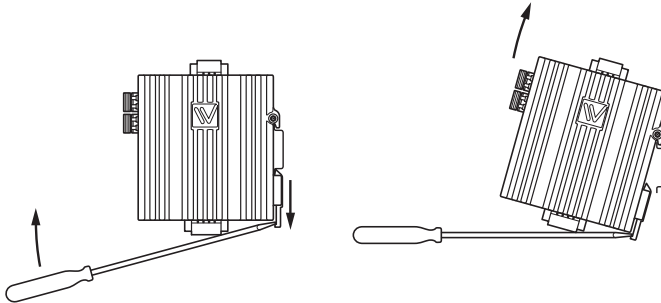

Cooling

This product uses convection cooling. To avoid obstructing the airflow around the product, use the following spacing rules. Minimum spacing 25 mm (1.0 inch) above / below and 10 mm (0.4 inches) left / right the product. Spacing is recommended for the use of product in full operating temperature range and service life.

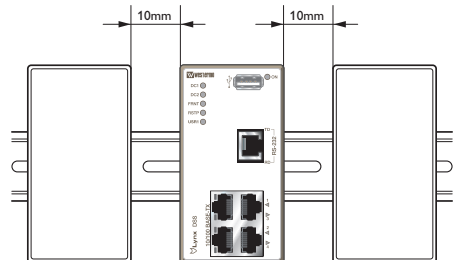

Getting Started

This product runs Westermo Operating System (WeOS) which provides several management tools that can be used for configuration of the product.

- **WeConfig tool**

This is a custom Westermo tool used for discovery of attached Westermo products.

Note! Version of WeConfig tool must be 10.4.0 or higher.

- **Web**

Configuration of the product using the web browser.

- **CLI**

Configuration of the product via the Command Line Interface.

Username: admin

Password: westermo

If the computer is located in the same subnet as the switch you can easily use a web browser to configure the product. Within the web you can configure most of the available functions.

For advanced network settings and more diagnostic information, please use the CLI. Detailed documentation is available in the chapter "The Command Line Management Tool" in the WeOS management guide. If you are not sure about the subnet - consult your network administrator.

Factory default *IP address:* 192.168.2.200

Netmask: 255.255.255.0

Gateway: Disabled

Configuration

Configure the product via web browser

The product can easily be configured via a web browser. Open the link <http://192.168.2.200> in your web browser, and you will be prompted with a Login screen, where the default settings for Username and Password are:

Username: admin

Password: westermo

Once you have logged in, you can use the extensive integrated help function describing all configuration options. Two common task when configuring a new switch is to assign appropriate IP settings, and to change the password of the admin account.

The password can be up to 64 characters long, and should consist of printable ASCII characters (ASCII 33-126); 'Space' is not a valid password character.



Note

Version of WeConfig tool must be 10.4.0 or higher.

Referring documents

Type	Description	Document number
Management Guide	Westermo OS management guide	6101-3201

Factory default on L205-S1 EX

It is possible to set the product to factory default settings by using two straight standard Ethernet RJ-45 cables.

1. Power off the switch and disconnect all Ethernet cables (copper and fibre).
2. Connect one Ethernet cable between Ethernet ports 1 and 4, and the other between Ethernet ports 2 and 3.

The ports need to be connected directly by an Ethernet cable, i.e., not via a hub or switch. Use a straight cable - not a cross-over cable - when connecting the ports.

3. Power on the product.
4. Wait for the product to start up. Control that the ON LED is flashing red. The ON LED flashing indicates that the product is now ready to be reset to factory default. You now have the choice to go ahead with the factory reset, or to skip factory reset and boot as normal.

- Go ahead with factory reset:

Acknowledge that you wish to conduct the factory reset by unplugging the Ethernet cables. The ON LED will stop flashing.

This initiates the factory reset process*, and the product will restart with factory default settings. When the switch has booted up, the ON LED will show a green light, and is now ready to use.

- Skip the factory reset:

To skip the factory reset process, just wait for approximately 30 seconds (after the ON LED starts flashing RED) without unplugging the Ethernet cables. The switch will conduct a normal boot with the existing settings.



Note

Do not power off the product while the factory reset process is in progress.

Dimensions

Measurements are stated in millimeters.

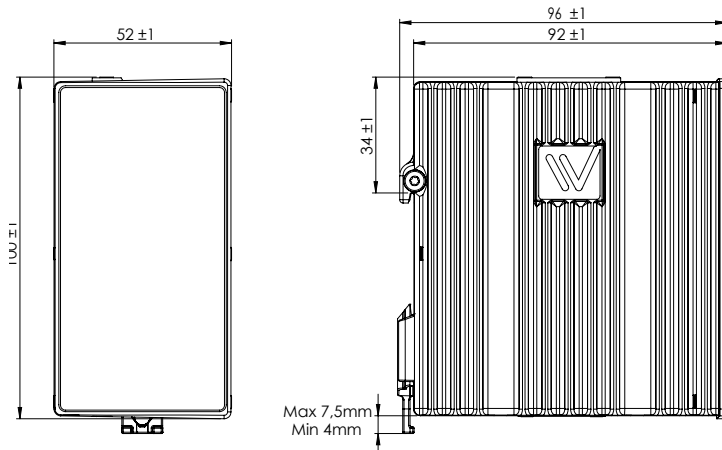

WESTERMO

Westermo • SE-635 35 Stora Sundby, Sweden
Tel +46 16 42 80 00 Fax +46 16 42 80 01
E-mail: info@westermo.com
www.westermo.com