

CYBOX AP 3

RAILWAY ACCESS POINT WITH WI-FI 5 WAVE 2 DUAL RADIO

CYBOX RT 3

RAILWAY ROUTER WITH 5G AND WI-FI 5 WAVE 2



INSTALLATION MANUAL

DISCLAIMER

Copyright

© 2022 ELTEC Elektronik AG. The information, data, and figures in this document including respective references have been verified and found to be legitimate. In particular in the event of error they may, therefore, be changed at any time without prior notice. The complete risk inherent in the utilization of this document or in the results of its utilization shall be with the user; to this end, ELTEC Elektronik AG shall not accept any liability. Regardless of the applicability of respective copyrights, no portion of this document shall be copied, forwarded or stored in a data reception system or entered into such systems without the express prior written consent of ELTEC Elektronik AG, regardless of how such acts are performed and what system is used (electronic, mechanic, photocopying, recording, etc.). All product and company names are registered trademarks of the respective companies.

Our General Business, Delivery, Offer, and Payment Terms and Conditions shall otherwise apply.

SAFETY INFORMATION

Electrical safety

	<p>WARNING</p> <p>The device can be operated with voltages over 75 V DC. Incorrect handling risks causing a fatal electrical shock.</p> <p>Before connecting the power supply, connect the device to protective earth.</p>
---	---

General advice

- Only qualified personnel is allowed to install, operate and maintain the devices.
- Please take safety precautions against electrostatic discharge (ESD).
- Access to the devices may only be granted to qualified personnel.
- To prevent the risk of electric shock, turn off the external power supply and remove the power supply cable from the electrical outlet before handling or disassembling the system.
- When adding or removing devices to or from the system, ensure that the power cables for the devices are unplugged before the signal cables are connected.
- Make sure that your power supply is set to the correct voltage in your area. If you are not sure about the voltage of the electrical outlet you are using, contact your local power company.
- If the power supply is broken, do not try to fix it by yourself. Contact a qualified service technician or your retailer.

Operation safety



WARNING

The device can become very hot during operation ($> 80^{\circ}\text{C}$).

Make sure it is protected from accidental contact.

The device must be installed so that it is not accessible to children.

To prevent burns, switch off the device and allow to cool down for half an hour before disassembling or working on it.

- Before installing the device and connecting cables to it, carefully read the related manuals.
- Before using the device, make sure all cables are correctly connected and the power cables are not damaged. If you detect any damage, contact your dealer immediately.
- Avoid dust, humidity, and temperature extremes. Do not place the product in any area where it may become wet.
- Place the product on a stable surface.
- If you encounter technical problems with the product, contact a qualified service technician or your retailer.

Radio Frequency Exposure Statement

At least 20 cm separation distance between the antenna and the user's body must be maintained at all times.

RECYCLING

Please recycle packaging environmentally friendly:



Packaging materials are recyclable. Please do not dispose packaging into domestic waste but recycle it.

Please recycle old or redundant devices environmentally friendly:



Old devices contain valuable recyclable materials that should be reutilized. Therefore please dispose old devices at collection points which are suitable.

EU DECLARATION OF CONFORMITY



ELTEC Elektronik AG herewith declares that the device is compliant to the basic requirements of the directive 2014/53/EU. The full text of the EU declaration of conformity is available in the Download Center at www.eltec.com.

CONTACT

ELTEC Elektronik AG
Galileo-Galilei-Straße 11
55129 Mainz
Germany

Fon +49 6131 918 100

Fax +49 6131 918 195

Email info@eltec.com

www www.eltec.com

CONTENTS

1	ABOUT THIS DOCUMENT	1
2	OVERVIEW	2
2.1	Products	2
3	HARDWARE	3
3.1	Device Connectors	3
3.1.1	Power Supply Connectors	3
3.1.2	Ethernet Interfaces	3
3.1.3	Antenna Connectors	4
3.2	Power Supply	5
3.2.1	Power Input	5
3.2.2	Power over Ethernet (PoE+)	5
3.3	M12 Service Interface (USB and Serial Port)	5
3.4	Front Panel and Module-to-Antenna Connections	6
3.4.1	Assignment Front Panel Labelling – Software	6
3.5	LED Indicators	7
3.5.1	Power LED Status	7
3.5.2	Fail LED Status	7
3.5.3	Module 1 LED Status	7
3.5.4	Module 2 LED Status	7
3.5.5	LAN LED (100 M 1000 M) Status	8
3.6	Reset Switch	8
3.7	SIM Cards	8
4	MOUNTING	11
4.1	Connecting an Earthing Cable	12
4.2	Electrical Connection	12

LIST OF TABLES

Table 1	Pin Assignment of Power Supply Connector (PWR)	3
Table 2	Pin Assignment of M12 Ethernet Connectors (LAN1/2)	3
Table 3	Pin Assignment of M12 Service Connector	5
Table 4	Overview Front Panel Antenna Description	6
Table 5	Power LED Status	7
Table 6	Fail LED Status	7
Table 7	Module 1 LED Status	7
Table 8	Module 2 LED Status	7
Table 9	LAN LED Status	8
Table 10	Reset Switch Behavior	8
Table 11	SIM card holder installation of the CyBox RT 3	9

LIST OF FIGURES

Figure 1	Picture of CyBox AP 3-W	2
Figure 2	Picture of CyBox RT 3-W	2
Figure 3	Front Panel Overview	6
Figure 4	SIM Slot Assignment per Modem of the CyBox RT 3	10
Figure 5	Dimensions of the CyBox AP 3 and CyBox RT 3 Housing	11
Figure 6	Earth Cable Mounting on Earth Stud	12

1 ABOUT THIS DOCUMENT

This installation manual is intended only for system developers and integrators; it is not intended for end users.

It describes the hardware functions of the product, connection of peripheral devices and integration into a system. Additional information on special applications and the configuration of the product is available in a separate configuration manual which can be downloaded from the Download Center at www.eltec.com.

2 OVERVIEW

2.1 PRODUCTS

This installation manual comprises all information to set-up the following products.



Figure 1 Picture of CyBox AP 3-W



Figure 2 Picture of CyBox RT 3-W

3 HARDWARE

3.1 DEVICE CONNECTORS

3.1.1 POWER SUPPLY CONNECTORS

The electrical power can be supplied to the device using the A-coded M12 power connector, labeled PWR.

Table 1 shows the pin-assignment of the power supply connector.

	PIN	SIGNAL NAME	DESCRIPTION
	1	+VIN	Supply voltage, positive terminal
	2	+VIN	Supply voltage, positive terminal
	3	-VIN	Supply voltage, negative terminal
	4	-VIN	Supply voltage, negative terminal

Table 1 Pin Assignment of Power Supply Connector (PWR)

3.1.2 ETHERNET INTERFACES

The two LAN-ports of the CyBox AP 3 and CyBox RT 3 are utilizing M12 X-coded connectors with the pin-assignment as shown in Table 2. Mating connectors are available from several manufacturers.

	PIN	SIGNAL NAME	DESCRIPTION
	1	D1+	First data line plus
	2	D1-	First data line minus
	3	D2+	Second data line plus
	4	D2-	Second data line minus
	5	D4+	Fourth data line plus
	6	D4-	Fourth data line minus
	7	D3-	Third data line minus
	8	D3+	Third data line plus

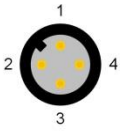
Table 2 Pin Assignment of M12 Ethernet Connectors (LAN1/2)

3.1.3 ANTENNA CONNECTORS

The QLS antenna connectors are located at the bottom part of the front panel. Besides the GNSS connector each radio interface connector is labeled from A1 to A4. Their functionalities depend on the CyBox model (see 3.4.1 Assignment Front Panel Labelling – Software).

When connecting an antenna to the QLS connector, make sure that you hear a 'click' sound confirming proper mounting.

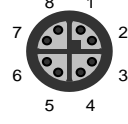
To remove an antenna, it has to be gently pulled from the basis of the connector with one hand, while the other hand is holding the antenna. Alternatively, a screwdriver can be used as a lever arm at the basis of the antenna to facilitate the removal, as illustrated below.



3.2 POWER SUPPLY

3.2.1 POWER INPUT

The CyBox AP 3 and CyBox RT 3 can be powered by a DC power source connected to the internal power supply and I/O connector, shown in Table 1 . The nominal input voltage can vary between 24 V and 110 VDC.

3.2.2 POWER OVER ETHERNET (POE+)

The CyBox AP 3 and CyBox RT 3 are designed to be supplied via the Ethernet uplink, as class 4 powered device, according to IEEE 802.3at. In this case the supply voltage is provided remotely over the injector.

Important: The Power-over-Ethernet option is applicable on certain devices only.

3.3 M12 SERVICE INTERFACE (USB AND SERIAL PORT)

The CyBox AP 3 and CyBox RT 3 are equipped with a USB and serial port. The USB port can be used to attach a memory device to update the firmware or to configure the device.

Note that the USB port is a dedicated maintenance port. It is not designed to be used while the device is in operation inside rolling stock equipment.

Table 3 shows the pin-assignment of the service connector.

	PIN	SIGNAL NAME	DESCRIPTION
	1	USB-VCC	USB positive power supply voltage
	2	USB-D-	USB negative data line
	3	USB-D+	USB positive data line
	4	USB-GND	USB negative power supply voltage
	5	n.c.	Not connected
	6	RS232-TX	Console port transmit data
	7	RS232-RX	Console port receive data
	8	RS232-GND	Console port ground

Table 3 Pin Assignment of M12 Service Connector

3.4 FRONT PANEL AND MODULE-TO-ANTENNA CONNECTIONS

The figure below provides an overview of the front panel.

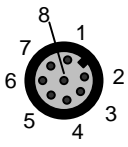
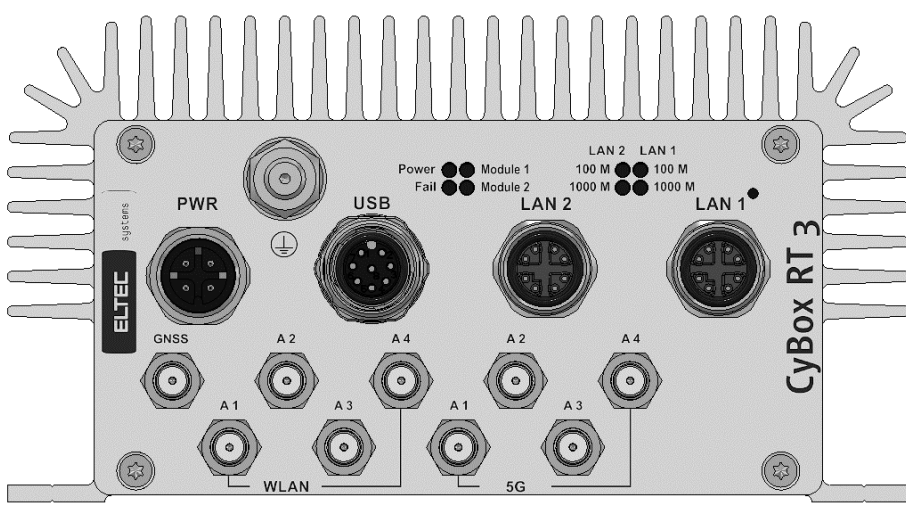

Figure 3 Front Panel Overview

3.4.1 ASSIGNMENT FRONT PANEL LABELLING – SOFTWARE

- The ports and LEDs “LAN 1” and “LAN 2” correspond respectively to the interfaces “eth0” and “eth1”
- The LEDs “Module 1” and “Module 2” refer to WLAN and/or 5G/LTE modules
- WLAN modules are called “radio” within the software
- 5G/LTE modules are called “modem” within the software
- The purpose of the antennas depends on the modules inserted in your Cybox model

CYBOX MODELS	LED ↔ SOFTWARE CORRELATION	ANTENNAS							
		WLAN1 A1	WLAN1 A2	WLAN1 A3	WLAN1 A4	WLAN2 A1	WLAN2 A2	WLAN2 A3	WLAN2 A4
Single WLAN	Module 1 ↔ Radio 0	WLAN1 A1	WLAN1 A2	WLAN1 A3	WLAN1 A4	not used	not used	not used	not used
Dual WLAN	Module 1 ↔ Radio 0 Module 2 ↔ Radio 1	WLAN1 A1	WLAN1 A2	WLAN1 A3	WLAN1 A4	WLAN2 A1	WLAN2 A2	WLAN2 A3	WLAN2 A4
Dual WLAN Ant. Comb.	Module 1 ↔ Radio 0 Module 2 ↔ Radio 1	WLAN1 2 A1	WLAN1 2 A2	WLAN1 2 A3	WLAN1 2 A4	not used	not used	not used	not used
5G/LTE + WLAN	Module 1 ↔ MODEM_S1 Module 2 ↔ Radio 0	5G/LTE1 A1	5G/LTE1 A2	5G/LTE1 A3	5G/LTE1 A4	WLAN1 A1	WLAN1 A2	WLAN1 A3	WLAN1 A4
Single 5G/LTE	Module 1 ↔ MODEM_S1	5G/LTE1 A1	5G/LTE1 A2	5G/LTE1 A3	5G/LTE1 A4	not used	not used	not used	not used
Dual 5G/LTE	Module 1 ↔ MODEM_S1 Module 2 ↔ MODEM_S2	5G/LTE1 A1	5G/LTE1 A2	5G/LTE1 A3	5G/LTE1 A4	5G/LTE2 A1	5G/LTE2 A2	5G/LTE2 A3	5G/LTE2 A4

Table 4 Overview Front Panel Antenna Description

3.5 LED INDICATORS

The LEDs on the front panel of CyBox AP 3 and CyBox RT 3 provide quick indication of the device status.

3.5.1 POWER LED STATUS

LED COLOR	STATE	DESCRIPTION
Green	On	Device is receiving correct input power
Green	Off	Device is not powered

Table 5 **Power LED Status**

3.5.2 FAIL LED STATUS

LED COLOR	STATE	DESCRIPTION
Green	On	Normal operation
Green	Off	Device is booting self-testing
Green	Blinking	Device is resetting to factory settings
Green	Toggle Green/Red	Emergency system booted
Red	On	Software Configuration error
Red	Off	Normal operation

Table 6 **Fail LED Status**

3.5.3 MODULE 1 LED STATUS

LED COLOR	STATE	DESCRIPTION
Green	On	Indicates module 1 is in use
Green	Blinking	Indicates data transfer on module 1
Green	Off	Indicates module 1 is inactive

Table 7 **Module 1 LED Status**

3.5.4 MODULE 2 LED STATUS

LED COLOR	STATE	DESCRIPTION
Green	On	Indicates module 2 is in use
Green	Blinking	Indicates data transfer on module 2
Green	Off	Indicates module 2 is inactive

Table 8 **Module 2 LED Status**

3.5.5 LAN LED (100 M | 1000 M) STATUS

LED COLOR	STATE	DESCRIPTION
Green	On	100 Mbit/s (resp. 1000 Mbit/s) link established
Green	Blinking	Indicates 100 Mbit/s (resp. 1000 Mbit/s) data transfer
Green	Off	No 100 Mbit/s (resp. 1000 Mbit/s) link

Table 9 LAN LED Status

3.6 RESET SWITCH

The CyBox AP 3 and CyBox RT 3 is equipped with a hidden reset switch behind the front panel, close to the top-right corner. The button is accessible with a straightened paper clip pushed through the little hole on the front panel. The effect of pressing the reset switch depends on the duration of its activation, as indicated in Table 10 below. The timing behavior is only valid if the device has completely booted (after approx. 1 min). While the device is booting or executing U-Boot, pushing the button will always reset the device.

The following table describes the functions of the reset switch.

HOLD TIME	FAIL LED BEHAVIOR	ACTION
< 2 seconds	Off	Reset after release
2-5 seconds	Off	No action
> 5 seconds	Green blinking	Remove custom configuration then reset

Table 10 Reset Switch Behavior

3.7 SIM CARDS

The Cybox RT 3 provides 4 SIM slots per 5G/LTE modem. Only one slot per modem can be active at any time. To install SIM cards, the back panel of the CyBox RT 3 has to be removed using a suitable torx 10 screwdriver. After installing the SIM cards, the back panel must be closed and the screws tightened to a maximum torque of 0.55 Nm. The indexing of SIM slots is software dependent and can be selected via an SNMP command or using the web interface.

Note: Switching between SIM slots takes about 30 seconds, slot 1 being preselected at power up. If you plan to use only one SIM card for a given 5G/LTE modem, it is advisable to use slot 1 to avoid slot switching delay during the boot phase.

The Cybox RT 3 provides a SIM card holder to prevent SIM cards from shaking out. The following table describes the procedure for the installation (example picture from previous generation).

NO.	FIGURE	DESCRIPTION
1		SIM card holder
2		<ol style="list-style-type: none"> 1. Remove the back panel by loosening the four screws with a suitable Torx 10 screwdriver. 2. Carefully take the SIM card holder out of the device by pulling it without loosening the antenna cables. 3. Install the SIM cards according to Figure 4 4. Slide the SIM card holder back over the PCB so that the SIM slots are in the groove of the holder. 5. Position the antenna cables in the cutouts of the SIM card holder. 6. Reattach the back panel by tightening the screws to a torque of 0.55 Nm.

Table 11 SIM card holder installation of the CyBox RT 3

The drawing in Figure 4 shows the SIM slot assignment per modem.

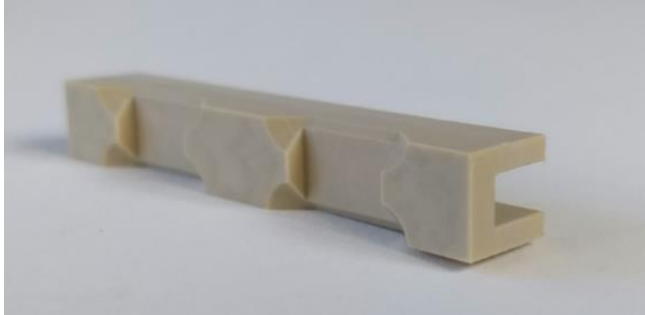
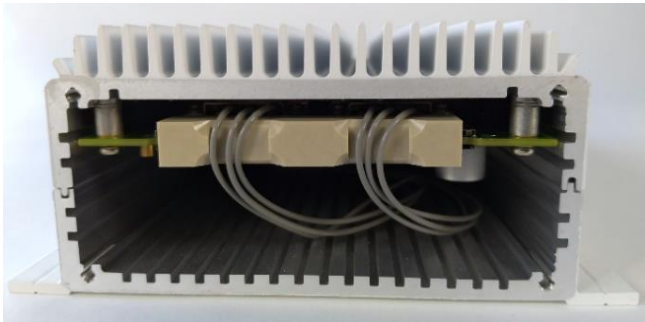
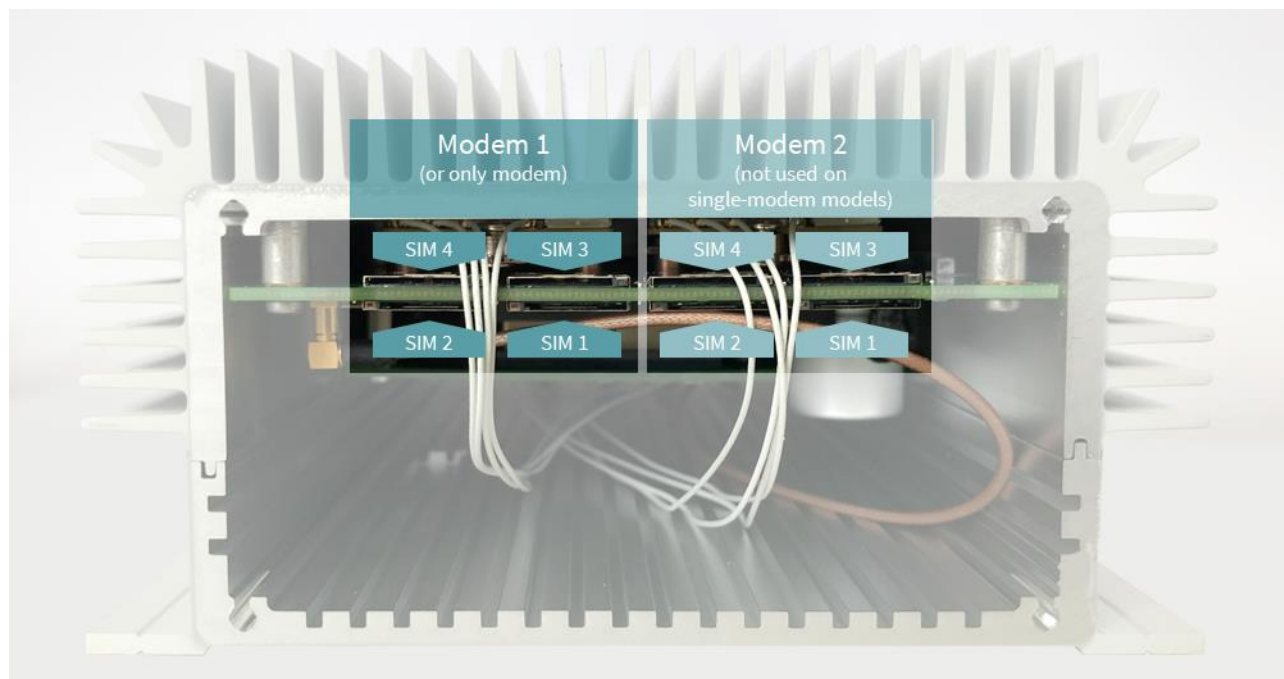

Figure 4 **SIM Slot Assignment per Modem of the CyBox RT 3**

Important: Do not change the SIM cards when the device is powered since there is a danger of touching the main voltage when the device is open.

4 MOUNTING

When mounting the CyBox AP 3 and CyBox RT 3, please take into account the following aspects:

- Do not install the device close to any sources of heat, such as radiators or heat registers.
- Keep the device away from any liquids and avoid exposure to dripping or splashing. The protection class of the housing is IP40.
- Keep a free space of at least 150 mm around the housing to ensure adequate heat dissipation capabilities.
- For optimal heat dissipation, the connectors should face down.
- The housing provides four mounting cutouts to install the device in horizontal or vertical orientation on a flat and stable surface.
- For fixation use M6 screws of sufficient length with additional M6 washers.

The drawing in Figure 5 shows the outer dimensions of the housing, including the position of the mounting cutouts.

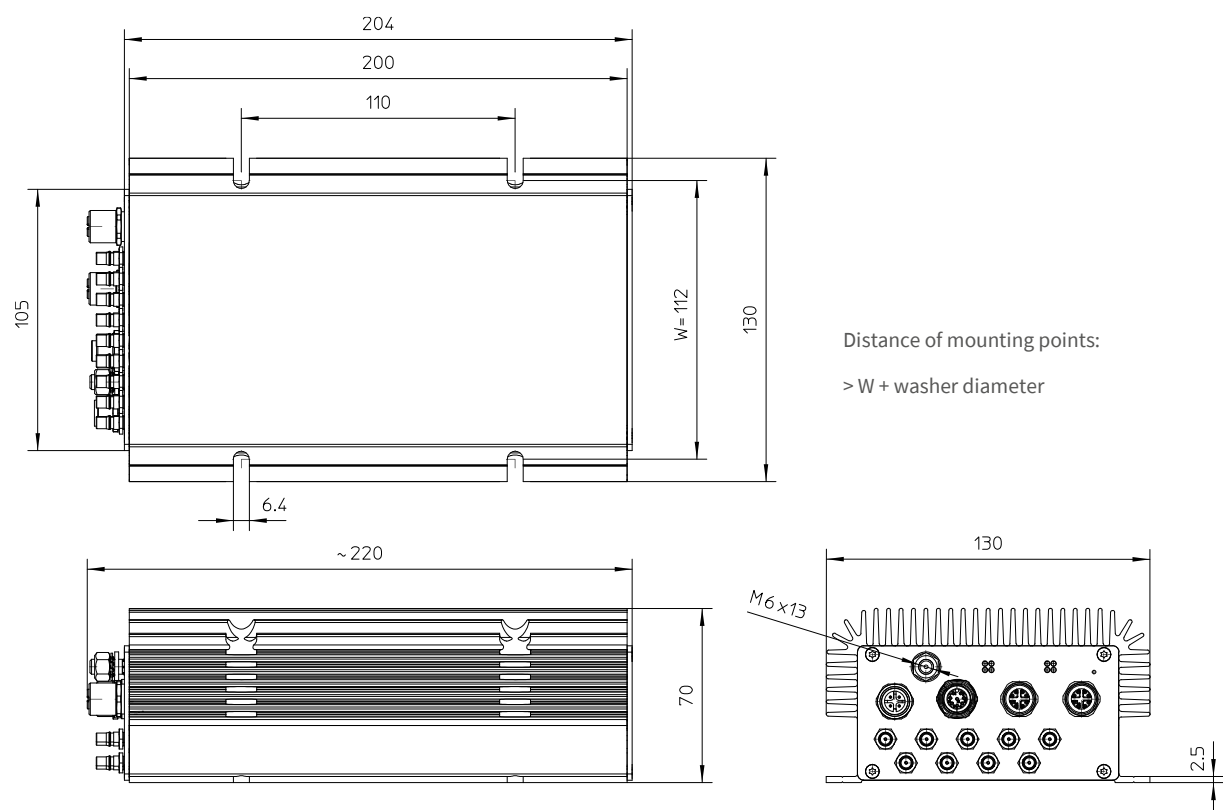

Figure 5 Dimensions of the CyBox AP 3 and CyBox RT 3 Housing

4.1 CONNECTING AN EARTHING CABLE

A M6 earthing stud on the front panel of the device (also refer to Figure 3) for protective earth connection is essential for the device security. Carry out the following steps to connect an earthing cable:

- Use an earthing cable with a cross-section of at least 2.5 mm² and a wire end sleeve with eyelet suitable for a 6 mm threaded bolt.
- Mount the earth cable as shown in Figure 6.
- Fasten the cable by tightening the nut to the required torque (recommended according to EN60947-1 are 3 Nm).

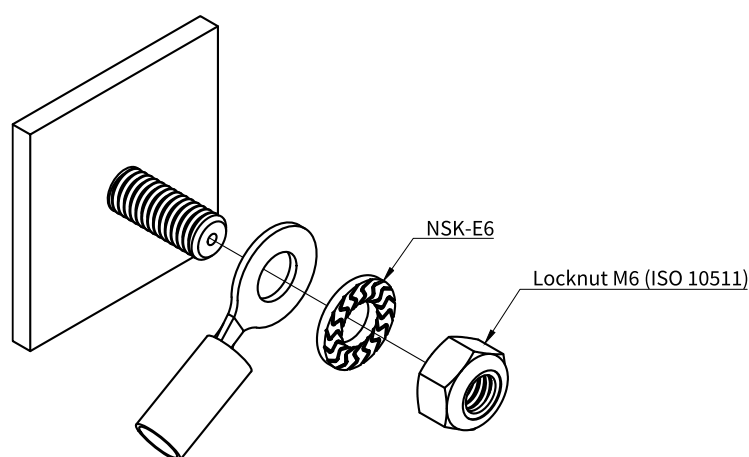

Figure 6 **Earth Cable Mounting on Earth Stud**

4.2 ELECTRICAL CONNECTION

1. Make sure the device is properly grounded.
2. Establish a connection to the network by plugging a M12 patch cable to one of the front panel M12 connectors. Each LAN port may be used, if the access point is supplied by a local power supply through the power supply connector. When using PoE+, the connector labeled LAN1 must be used.
3. Connect the desired number of antennas to the device. Each radio/modem can use up to four antennas for maximal performance.
4. In case of using a local power supply, the appropriate wiring (see Table 1) must be established to connect the power line to the device.
5. Make sure that the voltage of the power supply conforms to the voltage on the type plate.
6. Ensure that the power supply is grounded correctly and that the power cable is intact and undamaged. Do not switch on the system if there are damages on the power cable or plug.
7. Use power cables which are approved for the power supply in your country.
8. The device itself has no on/off switch, it starts as soon as it is supplied with power.