



**WESTERMO**

**i-line**

# **MRI-128-F4G-PSE/24**

**User's Manual**

Version 1.1

***Industrial Managed  
PoE Plus Ethernet Switch***

## **Copyright Notice**

Copyright © 2013 Westermo Teleindustri AB

All rights reserved.

Reproduction in any form or by any means without permission is prohibited.

## **Federal Communications Commission (FCC) Statement**

This equipment has been tested and found to comply with the limits for a Class A digital device, pursuant to Part 15 of the FCC Rules. These limits are designed to provide reasonable protection against harmful interference when the equipment is operated in a commercial environment. This equipment generates, uses, and can radiate radio frequency energy and, if not installed and used in accordance with the instruction manual, may cause harmful interference to radio communications. Operation of this equipment in a residential area is likely to cause harmful interference in which case the user will be required to correct the interference at his expense.

The user is cautioned that changes and modifications made to the equipment without approval of the manufacturer could void the user's authority to operate this equipment.

# Index

1	Introduction .....	2
1.1	Overview .....	2
1.2	Major Features .....	2
1.3	Package List .....	3
2	Hardware Installation.....	4
2.1	Hardware Introduction .....	4
2.2	Wiring Power Inputs .....	5
2.3	Power Supply Specifications .....	6
2.4	Wiring Digital Output.....	7
2.5	Wiring Earth Ground.....	7
2.6	Wiring Fast Ethernet Ports.....	8
2.7	Wiring Combo Ports.....	9
2.8	Wiring Fiber Ports.....	9
2.9	Data and Power Ports .....	9
2.10	Wiring RS-232 Console Cable.....	10
2.11	Rack Mounting Installation .....	10
2.12	Safety Warning.....	11
3	Preparation for Management .....	12
3.1	Preparation for Serial Console .....	12
3.2	Preparation for Web Interface .....	13
3.3	Preparation for Telnet Console .....	15
4	Feature Configuration .....	18
4.1	Command Line Interface Introduction.....	18
4.2	Basic Setting .....	24
4.3	Port Configuration.....	46
4.4	Power over Ethernet .....	58
4.5	Network Redundancy.....	70
4.6	VLAN.....	91
4.7	Private VLAN .....	103
4.8	Traffic Prioritization.....	110
4.9	Multicast Filtering .....	116
4.10	SNMP.....	122
4.11	Security .....	126
4.12	Warning.....	138
4.13	Monitor and Diag .....	149
4.14	Device Front Panel .....	159

4.15	Save to Flash.....	160
4.16	Logout .....	161
5	Appendix .....	162
5.1	Pin Assignment of the RS-232 Console Cable .....	162
5.2	Private MIB.....	163
5.3	Revision History.....	164

# **1 Introduction**

Welcome to MRI-128-F4G-PSE/24 Industrial Managed PoE Plus Switch User Manual. Following topics are covered in this chapter:

## **1.1 Overview**

### **1.2 Major Features**

### **1.3 Package Checklist**

## **1.1 Overview**

MRI-128-F4G-PSE/24 is rackmount High-Port Density and Gigabit Managed Industrial PoE Switch, designed exclusively for highly critical PoE applications such as real time IP video surveillance with high resolution quality and the evolving wireless communication systems such as Wimax and 802.11 a/b/g/n Access Points. The 24 Fast Ethernet PoE injector ports of the switch can deliver 15.4W by IEEE 802.3af or 30W by the High Power PoE IEEE 802.3at.

The 4 Gigabit Ethernet ports provide high speed uplink to connect with higher level backbone switches. With the MSR network redundancy technology, the switches can aggregate up to 12 fast ethernet and 2 gigabit rings while providing high quality data transmission with less than 300ms network recovery time. Furthermore, to ensure the traffic switching without data loss and blocking, the switch provides 12.8G backplane with the integrated non-blocking switching function. It incorporates LLDP function and perfectly works with the NMS for allowing administrators to automatically discover devices and efficiently manage the industrial network performance in large scale surveillance networks. To further ensure the non-stop power delivery, the switch supports dual 48VDC power inputs and provides alarm relay output signaling function. For high voltage requiring applications the PoE switch provides extra 90~264VAC or 127~370VDC power supply capability.

With the advanced Layer2 management features including IGMP Query/Snooping, DHCP, 256 VLAN, QoS, LACP, LPLD, etc. and the corrosion resistant robust design, the switch highly outstands from other PoE switches and becomes the revolutionary solution for industrial surveillance applications.

## **1.2 Major Features**

Westermo MRI-128-F4G-PSE/24 product has the following features:

- Up to 24 10/100 BaseTX and 4 Gigabit uplink ports
- Up to 24 ports support both 15.4W IEEE 802.3af and the latest 30W high power IEEE 802.3at, including 2-event and LLDP classification
- Flexible-bandwidth and long-distance data transmission by SFP transceivers
- Total power budget is 568W
- LPLD (Link Partner Live Detect Function) for reliable PoE connection through Active Powered Device status detection and auto reset function
- 12.8G Non-Blocking backplane, 16K MAC table for wire speed bidirectional switching
- IEEE 1588 PTP compliance for precise time synchronization
- MSR ring technology for aggregating up to 12 x 100Mb plus 2 Gigabit rings
- Supports up to 9,216 bytes Jumbo Frame for secured large file transmission
- IEEE 802.1AB LLDP for auto-topology and large network group management
- IGMP Query v1/v2 & Snooping v1/v2/v3 for advanced multicast filtering
- Up to 256 VLAN traffic isolation
- Advanced network management features support SNMP, RMON
- Supports DHCP client/server, DHCP Option 82 for automatic IP configuration
- Dual redundant low voltage range: 53VDC(46~57VDC) and HDC range: 90~264VAC or 127~370VDC

### **1.3 Package List**

The products are shipped with following items:

- The switch
- One RS-232 DB-9 console cable
- 19" rack mount adapters
- Documentation and Software CD

If any of the above items are missing or damaged, please contact your local sales representative.

## 2 Hardware Installation

This chapter includes hardware introduction, installation and configuration information.

Following topics are covered in this chapter:

- 2.1 Hardware Introduction
- 2.2 Wiring Power Inputs
- 2.3 Power Supply Specifications
- 2.4 Wiring Digital Input
- 2.5 Wiring Relay Output
- 2.6 Wiring Fast Ethernet Ports
- 2.7 Wiring Combo Ports
- 2.8 Wiring Fiber Ports
- 2.9 Data and Power Ports
- 2.10 Wiring RS-232 console cable
- 2.11 Rack Mounting Installation
- 2.12 Safety Warning

### 2.1 Hardware Introduction

#### Dimension

(H x W x D) is 43.8mm x 431mm x 375mm

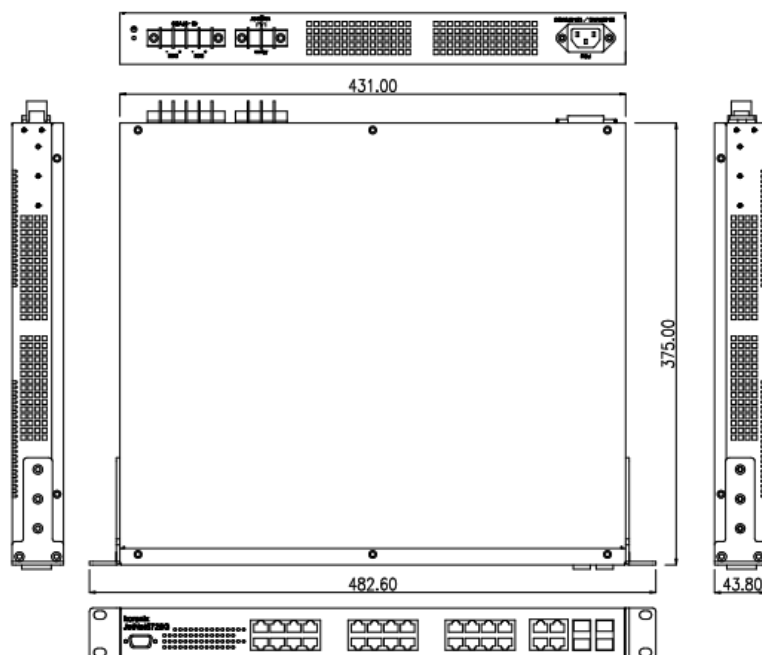

Diagram: MRI-128-F4G-PSE/24

## Panel Layout

The front panel includes up to 24 10/100Mbps Fast Ethernet ports, 4 combo Gigabit Ethernet ports, SFP slot, RS-232 console port, System / Combo Port LED and up to 24 PoE LED.

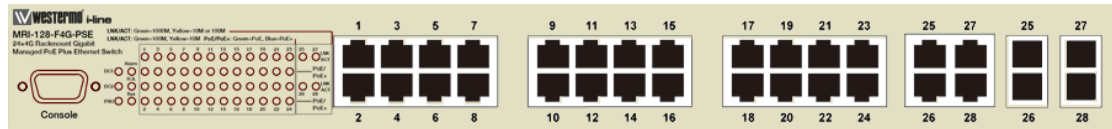
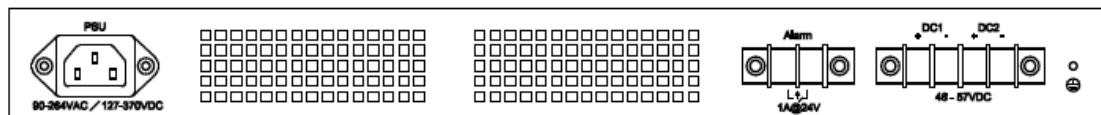

Diagram: MRI-128-F4G-PSE/24

The back panel consists of 2 DC power inputs, 1 AC Input, 1 Relay Output.



## 2.2 Wiring Power Inputs

The switch provides two types power input, AC power input and DC power input. It also provides redundant or aggregated power inputs, depending on the voltage of power input. If there are over two power inputs are connected with different voltages, it will be powered from the highest connected voltage (redundant power). If the voltages of power inputs are the same, the total power output will be aggregated (aggregated power).

### AC Power Input

Connect the attached power cord to the AC power input connector, the available AC power input is range from 90-264VAC.

### High Voltage Power Input

The power input support both 90-264VAC and 127-370VDC power input. Connect the power cord to the PE for Protective Earth, L / V+ for LINE or V+, N/V- for Neutral or V-. For high power input, tighten the wire-clamp screws to prevent DC wires from being loosened is must.

### DC Power Inputs

The range of the available DC power input is from 46-57VDC. In the IEEE802.3at mode, the PoE power output is 50~57 VDC, 0.6A, therefore, the suggested DC power input ranges is 52~57V. In the IEEE802.3af mode, the PoE power output is 44~57 VDC, 0.35A, therefore, the suggested DC power input is 46~57VDC.

If the DC power input is 53V, the unit will aggregate the power with the AC power input, if any.

Follow below steps to wire the redundant or aggregated DC power inputs.

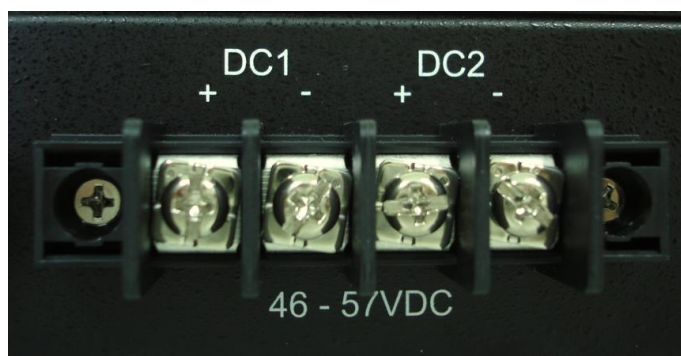

1. Insert positive and negative wires into V+ and V- contacts respectively of the terminal block connector.
2. Tighten the wire-clamp screws to prevent DC wires from being loosened.
3. DC1 and DC2 support polarity reverse protection functions.

**Note 1:** It is a good practice to turn off input and load power. Otherwise, your screwdriver blade can inadvertently short your terminal connections to the grounded enclosure.

**Note 2:** The range of the suitable electric wire is from 12 to 22 AWG.

**Note 3:** The unit will alarm for loss of power, for instance, PSU, DC1 or DC2.

### 2.3 Power Supply Specifications

Power Supply Type	Input Range		Fuse Rating	Max. Power Consumption
	Min	Max		All Ethernet Ports
48 VDC	46 VDC	57 VDC	10A(T)	28W
HI (250 VDC)	127 VDC	370 VDC	4A(T)	
HI (110/230 VAC)	90 VAC	264 VAC		

Table: Power Supply Specifications

MRI-128-F4G-P24

Power Supply Type	Input Range		Fuse Rating	Power Consumption	
	Min	Max		Worst Case	Max
48 VDC	46 VDC	57 VDC	1.5A(F)	369.6W	369.6W
53 VDC	52 VDC	57 VDC	1.5A(F)	568W	720W

Table: PoE/PoE Plus Power Supply Specifications

**Note 1:** (F) Denotes fast-acting fuse, (T) denotes time-delay fuse

**Note 2:** Power consumption varies based on configuration. 10/100Tx ports consume roughly 1W less than fiber optic ports

**Note 3:** For continued protection against risk of fire, replace only with same type and rating of fuse.

### 2.4 Wiring Digital Output

The switch provides one digital output, also known as Relay Output. The relay contacts are energized (open) for normal operation and will close for fault conditions. The fault conditions include power failure, Ethernet port link break or other pre-defined events which can be configured.

Wiring digital output is exactly the same as wiring power input introduced in chapter 2.2.

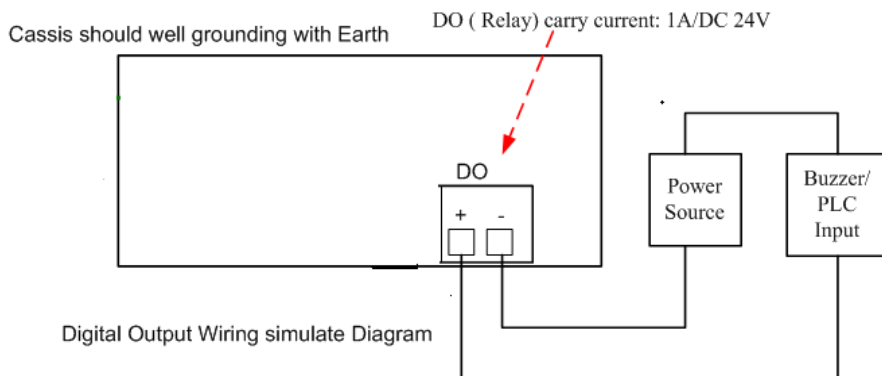

### 2.5 Wiring Earth Ground

To ensure the system will not be damaged by noise or any electrical shock, we suggest you to make exact connection with the switch with Earth Ground.

On the back panel, there is one earth ground screw. Loosen the earth ground screw using a screw driver; then tighten the screw after earth ground wire is connected.

## 2.6 Wiring Fast Ethernet Ports

The switch includes up to 24 RJ-45 Fast Ethernet ports. The Fast Ethernet ports support 10Base-T and 100Base-TX, full or half duplex modes. All the Fast Ethernet ports will auto-detect the signal from connected devices to negotiate the link speed and duplex mode. Auto MDI/MDIX allows users to connect another switch, hub or workstation without changing straight through or crossover cables.

Note that crossover cables simply cross-connect the transmit lines at each end to the received lines at the opposite end.

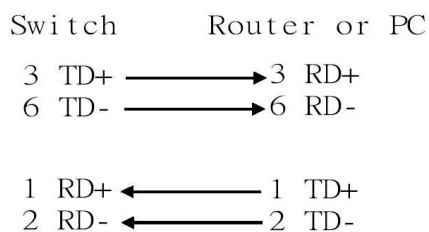

Straight-through Cabling Schematic

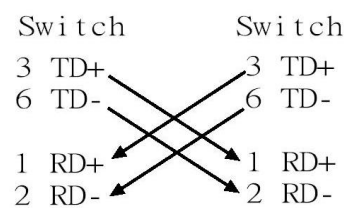

Cross-over Cabling Schematic

Note that Ethernet cables use pins 1, 2, 3, and 6 of an 8-pin RJ-45 connector. The signals of these pins are converted by the automatic MDI-X function, as shown in the table below:

Pin MDI-X	Signals	MDI Signals
1	RD+	TD+
2	RD-	TD-
3	TD+	RD+
6	TD-	RD-

Connect one side of an Ethernet cable into any switch port and connect the other side to your attached device. The LNK LED will light up when the cable is correctly connected. Refer to the **LED Indicators** section for descriptions of each LED indicator. Always make sure that the cables between the switches and attached devices (e.g. switch, hub, or workstation) are less than 100 meters (328 feet).

The wiring cable types are as below.

10Base-T : 2-pair UTP/STP Cat. 3, 4, 5 cable, EIA/TIA-568 100-ohm (100m)

100Base-TX: 2-pair UTP/STP Cat. 5 cable, EIA/TIA-568 100-ohm (100m)

1000Base-TX: 4-pair UTP/STP Cat. 5e cable, EIA/TIA-568 100-ohm (100m)

IEEE 802.3af : 4-pair UTP/STP Cat. 5 cable, EIA/TIA-568 100-ohm (100m)

IEEE 802.3at : 4-pair UTP/STP Cat. 5e / 6 cable, EIA/TIA-568 100-ohm (100m)

## 2.7 Wiring Combo Ports

The switch includes 4 RJ-45 Gigabit Ethernet ports which supports 10Base-T, 100Base-TX and 1000Base-TX. The switch is also equipped with 4 gigabit SFP ports combo which supports 1000Base-SX/LX and is according the standard MINI GBIC SFP transceiver.

## 2.8 Wiring Fiber Ports

### Small Form-factor Pluggable (SFP)

The SFP ports fulfill the SFP standard. To ensure the system reliability, it is recommended to use the approved Gigabit SFP Transceiver. The web user interface will show Unknown vendor type when choosing the SFP which is not approved.

The way to connect the SFP transceiver is to Plug in SFP fiber transceiver first. Cross-connect the transmit channel at each end to the receive channel at the opposite end as illustrated in the figure below.

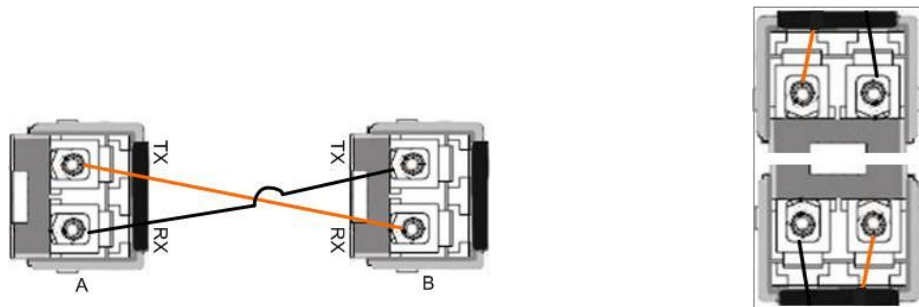

**Note: This is a Class 1 Laser/LED product. Don't look into the Laser/LED Beam.**

## 2.9 Data and Power Ports

The following table illustrates the Power ports and some features:

Models	Power ports	PoE/PoE+	Auto-sensing and Auto power off
MRI-128-F4G-PSE/24	Up to 24 ports	Up to 24 ports	Up to 24 ports

The following table shows the RJ45 PoE pin-out assignment.

10/100BaseTx PoE Pin-out	
Pin	Description
1	RX + and Vport -
2	RX – and Vport -
3	TX + and Vport +
6	TX – and Vport +
4, 5, 7, 8	NC

Table: RJ45 PoE pin-out assignment

### 2.10 Wiring RS-232 Console Cable

Westermo attaches one RS-232 DB-9 to RJ-45 cable in the box. Connect the DB-9 connector to the COM port of your PC, open Terminal tool and set up serial settings to 9600, N,8,1. (Baud Rate: 9600 / Parity: None / Data Bit: 8 / Stop Bit: 1) Then you can access the CLI interface using the console cable.

Note: If you have lost the cable, please contact your local sales or office or follow the pin assignment to buy/make a new one. The pin assignment spec is listed in the appendix.

### 2.11 Rack Mounting Installation

The Rack Mount Kit is attached inside the package box.

Attach the brackets to the device by using the screws provided in the Rack Mount kit.



Mount the device in the 19' rack by using four rack-mounting screws



When installing multiple switches, mount them in the rack one below the other. It's requested to reserve 0.5U-1U free space for multiple switches installing. This is important to disperse the heat generated by the switch.

Notice when installing:

- Temperature: Check if the rack environment temperature conforms to the specified operating temperature range.
- Mechanical Loading: Do not place any equipment on top of the switch
- Grounding: Rack-mounted equipment should be properly grounded.

## 2.12 Safety Warning

The equipment is intended for installation in a Restricted Access Location. And the below warning will be marked on the equipment in prominent position adjacent to the hot part.

## Warnings and Certifications

---



### **Restricted Access Location:**

This equipment is intended to be installed in a RESTRICTED ACCESS LOCATION only.

---

## **3 Preparation for Management**

The switch provides both in-band and out-band configuration methods. You can configure the switch via RS232 console cable if you don't attach your admin PC to your network, or if you lose network connection to the switch. This is so-called out-band management. It wouldn't be affected by network connectivity. The in-band management means you can remotely manage the switch via the network. You can choose Telnet or Web-based management. You just need to know the device's IP address and you can remotely connect to its embedded HTTP web pages or Telnet console. Following topics are covered in this chapter:

### **3.1 Preparation for Serial Console**

### **3.2 Preparation for Web Interface**

### **3.3 Preparation for Telnet console**

#### **3.1 Preparation for Serial Console**

In the package, Westermo attached one RS-232 DB-9 console cable. Please attach RS-232 DB-9 connector to your PC COM port, connect to the Console port of the the switch. If you lose/lost the cable, please follow the console cable PIN assignment to find a new one, or contact your closest Westermo sales office. (Refer to the appendix).

1. Go to Start -> Program -> Accessories -> Communication -> Hyper Terminal
2. Give a name to the new console connection.
3. Choose the COM name
4. Select correct serial settings. The serial settings of The switch are as below:  
Baud Rate: 9600 / Parity: None / Data Bit: 8 / Stop Bit: 1
5. After connected, you can see Switch login request.
6. Log into the switch. The default username is "admin", password, "westermo".

```
Switch login: admin
Password:

The switch (version 1.1-20101014-11:04:13) .

Switch>
```

## 3.2 Preparation for Web Interface

The switch provides HTTP Web Interface and Secured HTTPS Web Interface for web management.

### 3.2.1 Web Interface

Web management page is developed by JAVA. It allows you to use a standard web-browser such as Microsoft Internet Explorer, or Mozilla Firefox, to configure and/or log from the switch from anywhere on the network.

Before you attempt to use the embedded web interface to manage switch operation, verify that the switch is properly installed on your network and that every the PC on this network can access the switch via the web browser.

1. Verify that your network interface card (NIC) is operational, and that your operating system supports TCP/IP protocol.
2. Wire DC power to the switch and connect your switch to your computer.
3. Make sure that the switch default IP address is 192.168.2.200.
4. Change your computer IP address to 192.168.2.2 or other IP address which is located in the 192.168.2.x (Network Mask: 255.255.255.0) subnet.
5. Switch to DOS command mode and ping 192.168.2.200 to verify a normal response time.

Launch the web browser and Login.

6. Launch the web browser (Internet Explorer or Mozilla Firefox) on the PC.
7. Type **http://192.168.2.200** (or the IP address of the switch). And then press **Enter**.
8. The login screen will appear next.
9. Type in the user name and the password. Default user name is **admin** and password **westermo**.

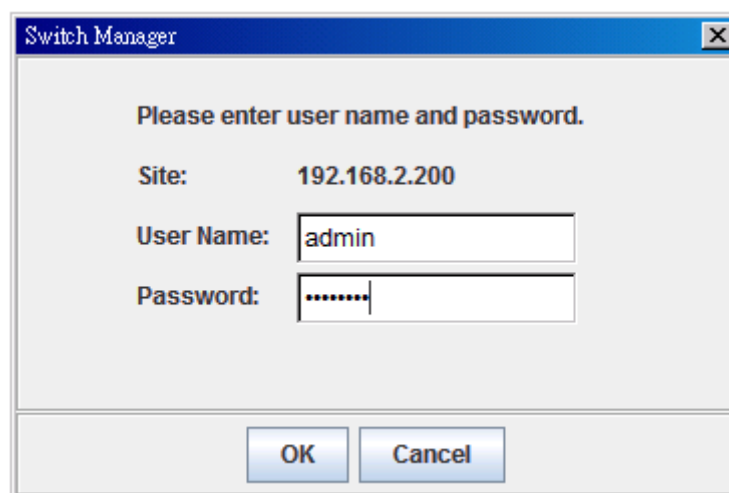

The image shows a Windows-style dialog box titled "Switch Manager". The dialog box has a blue title bar with a close button (X) in the top right corner. The main content area is light gray and contains the following text and fields:

- Text: "Please enter user name and password."
- Text: "Site: 192.168.2.200"
- Text: "User Name:" followed by a text input field containing the text "admin".
- Text: "Password:" followed by a password input field containing seven dots ".....".

At the bottom of the dialog box, there are two buttons: "OK" and "Cancel".

Click on **Enter** or **OK**. The welcome page of the web-based management

interface will then appear.

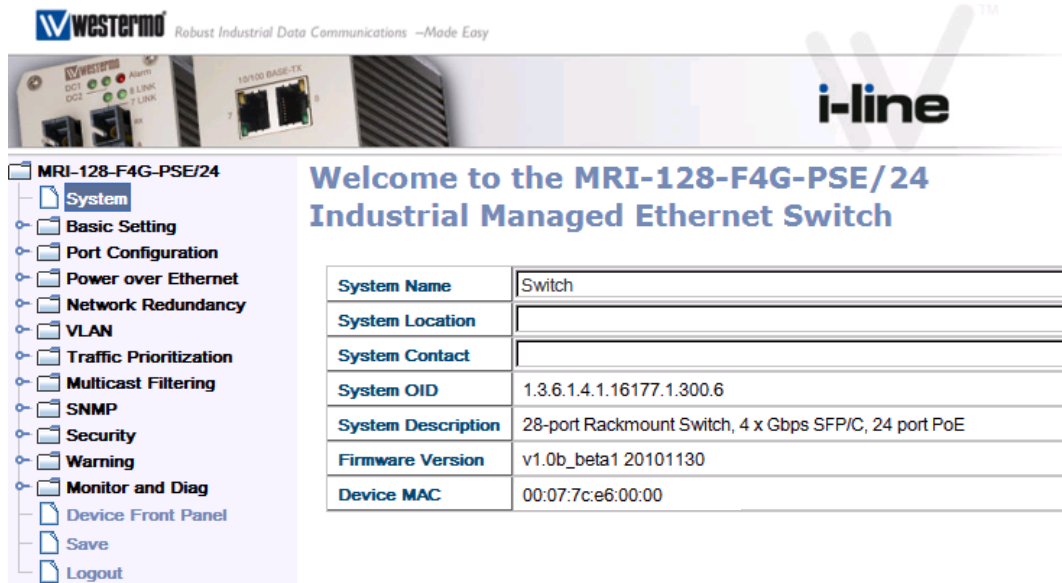

The screenshot displays the Westermo i-line web management interface. The top left features the Westermo logo and the tagline "Robust Industrial Data Communications –Made Easy". The top right shows the "i-line" logo. The main content area is titled "Welcome to the MRI-128-F4G-PSE/24 Industrial Managed Ethernet Switch". Below the title is a table with the following configuration details:

System Name	Switch
System Location	
System Contact	
System OID	1.3.6.1.4.1.16177.1.300.6
System Description	28-port Rackmount Switch, 4 x Gbps SFP/C, 24 port PoE
Firmware Version	v1.0b_beta1 20101130
Device MAC	00:07:7c:e6:00:00

The left navigation menu includes the following items: MRI-128-F4G-PSE/24, System, Basic Setting, Port Configuration, Power over Ethernet, Network Redundancy, VLAN, Traffic Prioritization, Multicast Filtering, SNMP, Security, Warning, Monitor and Diag, Device Front Panel, Save, and Logout.

Once you enter the web-based management interface, you can freely change the IP address to fit your network environment.

**Note 1:** Internet Explorer 5.0 or later versions do not allow Java applets to open sockets by default. Users have to directly modify the browser settings to selectively enable Java applets to use network ports.

**Note 2:** The Web UI connection session of The switch will be logged out automatically if you don't give any input after 30 seconds. After logged out, you should re-login and type in the correct user name and password again.

### 3.2.2 Secured Web Interface

Westermo web management page also provides secured management HTTPS login. All the configuration commands will be secured.

Launch the web browser and Login.

1. Launch the web browser (Internet Explorer or Mozilla Firefox) on the PC.
2. Type **https://192.168.2.200** (or the IP address of the switch). And then press **Enter**.
3. The popup screen will appear and request you to trust the secured HTTPS connection. Press **Yes** to trust it.
4. The login screen will appear next.

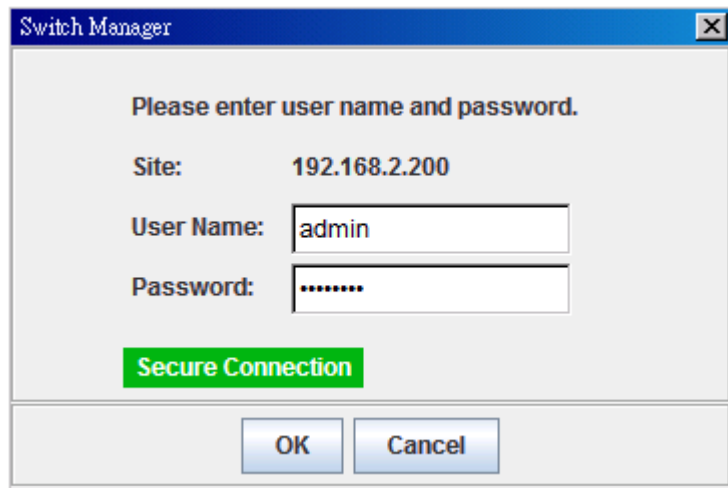

5. Key in the user name and the password. The default user name is **admin** and password is **westermo**.
6. Press **Enter** or click on **OK**. The welcome page of the web-based management interface will then appear.
7. Once you enter the web-based management interface, all the commands you see are the same as what you see by HTTP login.

### 3.3 Preparation for Telnet Console

#### 3.3.1 Telnet

The switch supports Telnet console. You can connect to the switch by Telnet and the command lines are the same as what you see by RS232 console port. Below are the steps to open Telnet connection to the switch.

1. Go to Start -> Run -> cmd. And then press **Enter**
2. Type the **telnet 192.168.2.200** (or the IP address of the switch). And then press **Enter**

#### 3.3.2 SSH (Secure Shell)

The switch also support SSH console. You can remotely connect to the switch by command line interface. The SSH connection can secure all the configuration commands you send to the switch.

When you wish to establish a SSH connection with the switch, you should download the SSH client tool first.

##### SSH Client

There are many free, sharewares, trials or charged SSH clients you can find on the internet. For example, PuTTY is a free and popular Telnet/SSH client. We'll use this tool to demonstrate how to login SSH

## Open SSH Client/PuTTY

In the **Session** configuration, enter the **Host Name** (IP Address of your The switch) and **Port number** (default = 22). Choose the “SSH” protocol. Then click on “**Open**” to start the SSH session console.

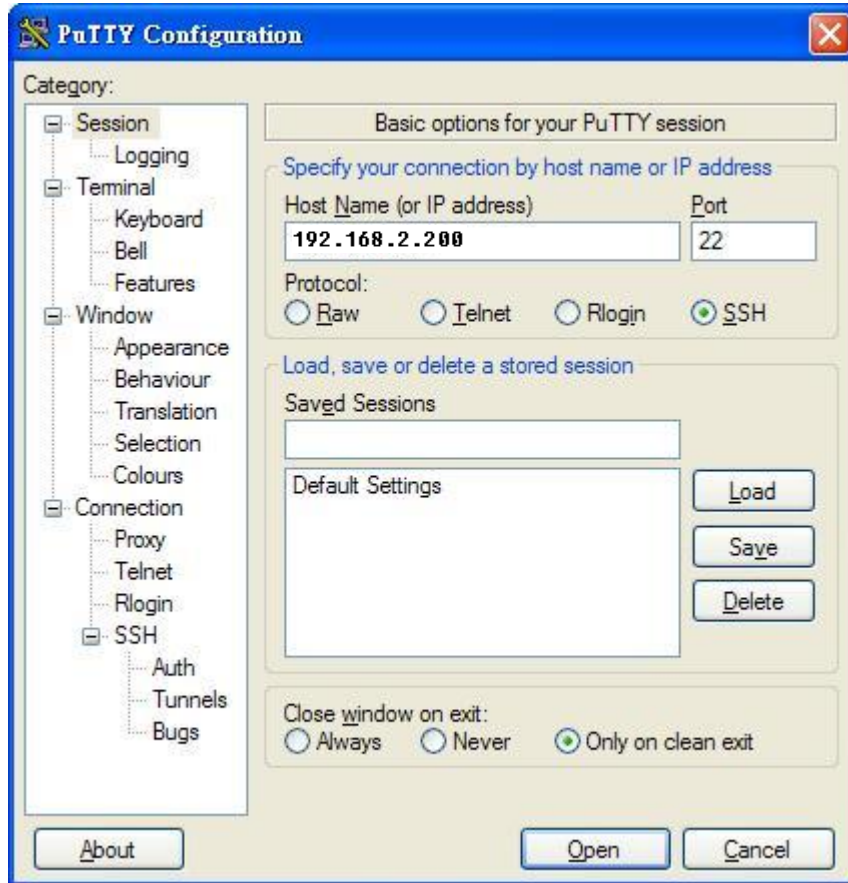

After click on **Open**, then you can see the cipher information in the popup screen. Press **Yes** to accept the Security Alert.

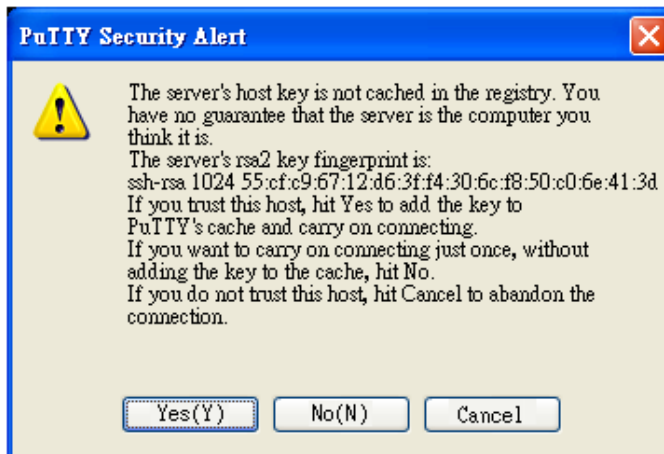

After few seconds, the SSH connection to the switch is opened.

Type the Login Name and its Password. The default Login Name and Password are **admin / westermo**.

All the commands you see in SSH are the same as the CLI commands you see via RS232 console. The next chapter will introduce in detail how to use command line to configure the switch.

# 4 Feature Configuration

This chapter explains how to configure the switch software features. There are four ways to access the switch: Serial console, Telnet/SSH, Web browser and SNMP.

Following topics are covered in this chapter:.

- 4.1 Command Line Interface (CLI) Introduction
- 4.2 Basic Setting
- 4.3 Port Configuration
- 4.4 Power over Ethernet
- 4.5 Network Redundancy
- 4.6 VLAN
- 4.7 Traffic Prioritization
- 4.8 Multicast Filtering
- 4.9 SNMP
- 4.10 Security
- 4.11 Warning
- 4.12 Monitor and Diag
- 4.13 Device Front Panel
- 4.14 Save
- 4.15 Logout

## 4.1 Command Line Interface Introduction

The Command Line Interface (CLI) is one of the user interfaces to the switch's embedded software system. You can view the system information, show the status, configure the switch and receive a response back from the system by typing in a command.

There are different command modes and each mode has its own access ability, available command lines and uses different command lines to enter and exit. These modes are User EXEC, Privileged EXEC, Global Configuration and (Port/VLAN) Interface Configuration modes.

**User EXEC mode:** As long as you log into the switch by CLI you are in the User EXEC mode. You can ping, telnet remote device, and show some basic information.

Type **enable** to enter the next mode, **exit** to logout. **?** to see the command list

```

Switch>
enable      Turn on privileged mode command
exit        Exit current mode and down to previous mode
list        Print command list
ping        Send echo messages
quit        Exit current mode and down to previous mode
show        Show running system information
telnet      Open a telnet connection
traceroute  Trace route to destination

```

**Privileged EXEC mode:** Type **enable** in the User EXEC mode, then you can enter the Privileged EXEC mode. In this mode, the system allows you to view current configuration, reset default, reload switch, show system information, save configuration and enter the global configuration mode.

Type **configure terminal** to enter next mode, **exit** to leave. **?** to see the command list

```

Switch#
archive     manage archive files
clear       Reset functions
clock       Configure time-of-day clock
configure   Configuration from vty interface
copy        Copy from one file to another
debug       Debugging functions (see also 'undebug')
disable     Turn off privileged mode command
end         End current mode and change to enable mode
exit        Exit current mode and down to previous mode
list        Print command list
more        Display the contents of a file
no          Negate a command or set its defaults
ping        Send echo messages
quit        Exit current mode and down to previous mode
reboot      Reboot system
reload      copy a default-config file to replace the current one
show        Show running system information

```

**Global Configuration Mode:** Type **configure terminal** in privileged EXEC mode and you will then enter global configuration mode. In global configuration mode, you can configure all the features that the system provides you.

Type **interface IFNAME/VLAN** to enter interface configuration mode, **exit** to leave. **?** to see the command list.

Available command lists of global configuration mode.

```

Switch# configure terminal
Switch(config)#
  access-list      Add an access list entry
  administrator    Administrator account setting
  arp              Set a static ARP entry
  clock           Configure time-of-day clock
  default         Set a command to its defaults
  end             End current mode and change to enable mode
  exit           Exit current mode and down to previous mode
  gvrp          GARP VLAN Registration Protocol
  hostname       Set system's network name
  interface      Select an interface to configure
  ip            IP information
  lacp         Link Aggregation Control Protocol
  list         Print command list
  log         Logging control
  mac        Global MAC configuration subcommands
  mac-address-table mac address table
  mirror     Port mirroring
  no        Negate a command or set its defaults
  ntp      Configure NTP
  password Assign the terminal connection password
  qos     Quality of Service (QoS)
  relay   relay output type information
  smtp-server SMTP server configuration
  snmp-server SNMP server
  spanning-tree spanning tree algorithm
  super-ring super-ring protocol
  trunk     Trunk group configuration
  vlan     Virtual LAN
  warning-event Warning event selection
  write-config Specify config files to write to

```

**(Port) Interface Configuration:** Type **interface IFNAME** in global configuration mode and you will then enter interface configuration mode, where you can configure port settings.

The port interface name for Fast Ethernet port 1 is fa1,... Fast Ethernet 7 is fa7, gigabit Ethernet port 25 is gi25.. Gigabit Ethernet port 27 is gi27. Type interface name accordingly when you want to enter certain interface configuration mode.

Type **exit** to leave.

Type **?** to see the command list

Available command lists of the global configuration mode.

```

Switch(config)# interface fa1
Switch(config-if)#
  acceptable          Configure 802.1Q acceptable frame types of a port.
  auto-negotiation    Enable auto-negotiation state of a given port
  description         Interface specific description
  duplex             Specify duplex mode of operation for a port
  end                End current mode and change to enable mode
  exit              Exit current mode and down to previous mode
  flowcontrol        Set flow-control value for an interface
  garp              General Attribute Registration Protocol
  ingress           802.1Q ingress filtering features
  lacp             Link Aggregation Control Protocol
  list             Print command list
  loopback         Specify loopback mode of operation for a port
  mac             MAC interface commands
  mdix            Enable mdix state of a given port
  no              Negate a command or set its defaults
  qos             Quality of Service (QoS)
  quit            Exit current mode and down to previous mode
  rate-limit      Rate limit configuration
  shutdown        Shutdown the selected interface
  spanning-tree   spanning-tree protocol
  speed          Specify the speed of a Fast Ethernet port or a
Gigabit Ethernet port.
  switchport      Set switching mode characteristics

```

**(VLAN) Interface Configuration:** Press **interface VLAN VLAN-ID** in global configuration mode and you will then enter VLAN interface configuration mode, where you can configure the settings for the specific VLAN.

The VLAN interface name of VLAN 1 is VLAN 1, VLAN 2 is VLAN 2...

Type **exit** to leave the mode. Type **?** to see the available command list.

The command lists of the VLAN interface configuration mode.

```

Switch(config)# interface vlan 1
Switch(config-if)#
  description      Interface specific description
  end             End current mode and change to enable mode
  exit           Exit current mode and down to previous mode
  ip            Interface Internet Protocol config commands
  list         Print command list
  no          Negate a command or set its defaults
  quit       Exit current mode and down to previous mode
  shutdown   Shutdown the selected interface

```

Summary of the 5 command modes.

Command Mode	Main Function	Enter and Exit Method	Prompt
User EXEC	This is the first level of access.	Enter: <b>login</b> successfully	Switch>

	User can ping, telnet remote device, and show some basic information	Exit: <b>exit</b> to logout. Next mode: Type <b>enable</b> to enter privileged EXEC mode.	
Privileged EXEC	In this mode, the system allows you to view current configuration, reset default, reload switch, show system information, save configuration...and enter global configuration mode.	Enter: Type <b>enable</b> in User EXEC mode. Exec: Type <b>disable</b> to exit to user EXEC mode. Type <b>exit</b> to logout Next Mode: Type <b>configure terminal</b> to enter global configuration command.	Switch#
Global configuration	In global configuration mode, you can configure all the features that the system provides you	Enter: Type <b>configure terminal</b> in privileged EXEC mode Exit: Type <b>exit</b> or <b>end</b> or press <b>Ctrl-Z</b> to exit. Next mode: Type <b>interface IFNAME/ VLAN VID</b> to enter interface configuration mode	Switch(config)#
Port Interface configuration	In this mode, you can configure port related settings.	Enter: Type <b>interface IFNAME</b> in global configuration mode. Exit: Type <b>exit</b> or <b>Ctrl+Z</b> to global configuration mode. Type <b>end</b> to privileged EXEC mode.	Switch(config-if)#
VLAN Interface Configuration	In this mode, you can configure settings for specific VLAN.	Enter: Type <b>interface VLAN VID</b> in global configuration mode. Exit: Type <b>exit</b> or <b>Ctrl+Z</b> to global configuration mode. Type <b>end</b> to privileged EXEC mode.	Switch(config-vlan)#

Here are some useful commands to see available commands. It can save your time when typing and avoid errors.

? To see all the available commands in this mode. It helps you to see the next command you can/should type as well.

```
Switch(config)# interface (?)
  IFNAME Interface's name
  vlan      Select a vlan to configure
```

(Character)? To see all the available commands starts from this character.

```
Switch(config)# a?
  access-list      Add an access list entry
  administrator    Administrator account setting
  arp              Set a static ARP entry
```

**Tab** This tab key helps you to input the command quicker. If there is only one available command in the next, clicking on tab key can help to finish typing soon.

```
Switch# co (tab) (tab)
Switch# configure terminal

Switch(config)# ac (tab)
Switch(config)# access-list
```

**Ctrl+C** To stop executing the unfinished command.

**Ctrl+S** To lock the screen of the terminal. You can't input any command.

**Ctrl+Q** To unlock the screen which is locked by Ctrl+S.

**Ctrl+Z** To exit configuration mode.

Alert message when multiple users want to configure the switch. If the administrator is in configuration mode, then the Web users can't change the settings. The switch allows only one administrator to configure the switch at a time.

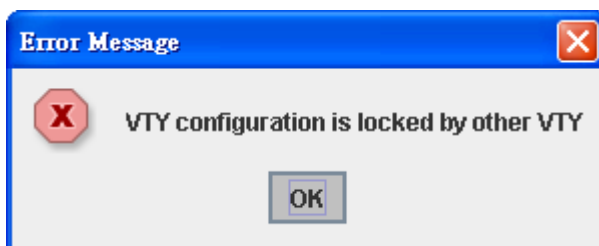

## 4.2 Basic Setting

The Basic Setting group provides you to configure switch information, IP address, User name/Password of the system. It also allows you to do firmware upgrade, backup and restore configuration, reload factory default, and reboot the system.

Following commands are included in this chapter:

- 4.2.1 Switch Setting
- 4.2.2 Admin Password
- 4.2.3 IP Configuration
- 4.2.4 Time Setting
- 4.2.5 Jumbo Frame
- 4.2.6 DHCP Server
- 4.2.7 Backup and Restore
- 4.2.8 Firmware Upgrade
- 4.2.9 Factory Default
- 4.2.10 System Reboot
- 4.2.11 CLI Commands for Basic Setting

### 4.2.1 Switch Setting

You can assign System name, Location, Contact and view system information.

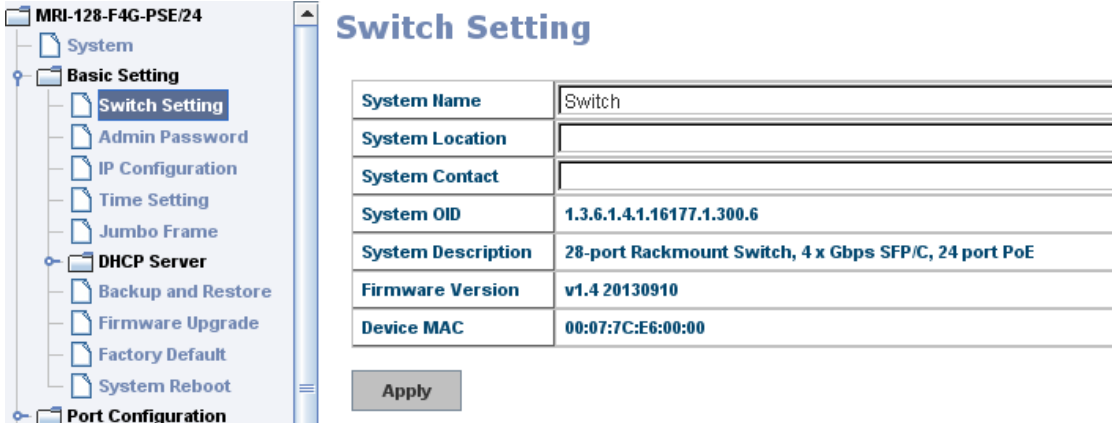

System Name	Switch
System Location	
System Contact	
System OID	1.3.6.1.4.1.16177.1.300.6
System Description	28-port Rackmount Switch, 4 x Gbps SFP/C, 24 port PoE
Firmware Version	v1.4 20130910
Device MAC	00:07:7C:E6:00:00

Apply

**System Name:** You can assign a name to the switch. The available characters you can input is 64. After you configure the name, CLI system will select the first 12 characters as the name in CLI system.

**System Location:** You can specify the switch's physical location here. The available characters you can input are 64.

**System Contact:** You can specify contact people here. You can type the name, mail

address or other information of the administrator. The available characters you can input are 64.

**System OID:** The SNMP object ID of the switch. You can follow the path to find its private MIB in MIB browser. (**Note:** When you attempt to view private MIB, you should compile private MIB files into your MIB browser first.)

**System Description:** The name of this product.

**Firmware Version:** Display the firmware version installed in this device.

**MAC Address:** Display unique hardware address (MAC address) assigned by the manufacturer.

Once you finish the configuration, click on **Apply** to apply your settings.

**Note:** Always remember to select **Save** to save your settings. Otherwise, the settings you made will be lost when the switch is powered off.

#### 4.2.2 Admin Password

You can change the user name and the password here to enhance security.

### Admin Password

Name	admin
Password	*****
Confirm Password	*****

Apply

**User name:** You can type in a new user name here. The default setting is **admin**.

**Password:** You can type in a new password here. The default setting is **westermo**.

**Confirm Password:** You need to type the new password again to confirm it.

Once you finish configuring the settings, click on **Apply** to apply your configuration.

Figure 4.2.2.2 Popup alert window for incorrect user name.

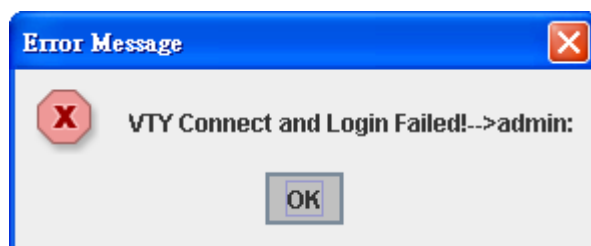

### 4.2.3 IP Configuration

This function allows users to configure the switch's IP address settings.

IP Configuration	
DHCP Client	Disable ▼
IP Address	192.168.2.200
Subnet Mask	255.255.255.0
Default Gateway	
DNS Server 1	
DNS Server 2	
<input type="button" value="Apply"/>	

**DHCP Client:** You can select to **Enable** or **Disable** DHCP Client function. When DHCP Client function is enabled, an IP address will be assigned to the switch from the network's DHCP server. In this mode, the default IP address will therefore be replaced by the one assigned by DHCP server. If DHCP Client is disabled, then the IP address that you specified will be used instead.

**IP Address:** You can assign the IP address reserved by your network for your switch. If DHCP Client function is enabled, you don't need to assign an IP address to the switch, as it will be overwritten by DHCP server and shown here. The default IP is 192.168.2.200.

**Subnet Mask:** You can assign the subnet mask for the IP address here. If DHCP Client function is enabled, you don't need to assign the subnet mask. The default Subnet Mask is 255.255.255.0.

**Note:** In the CLI, we use the enabled bit of the subnet mask to represent the number displayed in web UI. For example, 8 stands for 255.0.0.0; 16 stands for 255.255.0.0; 24 stands for 255.255.255.0.

**Default Gateway:** You can assign the gateway for the switch here. **Note:** In CLI, we use 0.0.0.0/0 to represent for the default gateway.

Once you finish configuring the settings, click on **Apply** to apply your configuration.

**IPv6 Configuration** –An IPv6 address is represented as eight groups of four hexadecimal digits, each group representing 16 bits (two octets). The groups are separated by colons (:), and the length of IPv6 address is 128bits.

An example of an IPv6 address is: 2001:0db8:85a3:0000:0000:8a2e:0370:7334.

The default IP address of Managed Switch is fe80:0:0:0:212:77ff:fe60:ca90, and the Leading zeroes in a group may be omitted. Thus, the example address may be

written as: fe80::212:77ff:fe60:ca90.

### IPv6 Configuration

IPv6 Address	Prefix
<input type="text"/>	<input type="text"/>

IPv6 Address	Prefix
fe80::207:7cff:fee6:0	64
<input type="text"/>	<input type="text"/>

**IPv6 Address field:** typing new IPv6 address in this field.

**Prefix:** the size of subnet or network, and it equivalent to the subnetmask, but written in different. The default subnet mask length is 64bits, and written in decimal value -64.

**Add:** after add new IPv6 address and prefix, don't forget click icon-"Add" to apply new address to system.

**Remove:** select existed IPv6 address and click icon-"Remove" to delete IP address.

**Reload:** refresh and reload IPv6 address listing.

**IPv6 Default Gateway:** assign the IPv6 default gateway here. Type IPv6 address of the gateway then click "Apply". Note: In CLI, we use ::0 to represent for the IPv6 default gateway.

### IPv6 Default Gateway

Default Gateway
<input type="text"/>

**IPv6 Neighbor Table:** shows the IPv6 address of neighbor, connected interface, MAC address of remote IPv6 device, and current state of neighbor device.

## IPv6 Neighbor Table

Neighbor	Interface	MAC address	State
fe80::207:7cff:fee6:1	vlan1	00:07:7c:e6:00:01	REACHABLE

Reload

The system will update IPv6 Neighbor Table automatically, and user also can click the icon “**Reload**” to refresh the tabale.

### 4.2.4 Time Setting

Time Setting source allow user to set the time manually or via a NTP server. Network Time Protocol (NTP) is used to synchronize computer clocks in a network internet. You can configure NTP settings here to synchronize the clocks of several switches on the network.

It also provides Daylight Saving Time function.

**Time Setting**

System Time: Thu Jan 1 00:43:55 2009

**Time Setting Source** Manual Setting

**Manual Setting** Get Time From PC

Jan 01, 2009 00:43:55

**IEEE 1588**

**PTP State** Disable

**Mode** Auto

**Timezone Setting**

**Timezone** (GMT) Greenwich Mean Time: Dublin, Edinburgh, Lisbon, London

**Daylight Saving Time**

**Daylight Saving Start** 1st Sun in Jan at 00:00

**Daylight Saving End** 1st Sun in Jan at 00:00

Apply

**Manual Setting:** User can select “**Manual setting**” to change time as user wants. User also can click the button “**Get Time from PC**” to get PC’s time setting for switch. After click the “**Get Time from PC**” and apply the setting, the System time display the same time as your PC’s time.

**NTP client:** Set Time Setting Source to NTP client to enable the NTP client service. NTP client will be automatically enabled if you change Time source to NTP Client. The system will send requests to acquire current time from the configured NTP server.

**IEEE 1588:** With the **Precision Time Protocol IEEE 1588**

is a high-precision time protocol for synchronization used in control system on a network.

To enable IEEE 1588, select Enable in PTP Status and choose Auto, Master or Slave Mode. After time synchronized, the system time will display the correct time of the PTP server.

**Time-zone:** Select the time zone where the switch is located. Following table lists the time zones for different locations for your reference. The default time zone is GMT Greenwich Mean Time.

Switch(config)# clock timezone

- 01 (GMT-12:00) Eniwetok, Kwajalein
- 02 (GMT-11:00) Midway Island, Samoa
- 03 (GMT-10:00) Hawaii
- 04 (GMT-09:00) Alaska
- 05 (GMT-08:00) Pacific Time (US & Canada) , Tijuana
- 06 (GMT-07:00) Arizona
- 07 (GMT-07:00) Mountain Time (US & Canada)
- 08 (GMT-06:00) Central America
- 09 (GMT-06:00) Central Time (US & Canada)
- 10 (GMT-06:00) Mexico City
- 11 (GMT-06:00) Saskatchewan
- 12 (GMT-05:00) Bogota, Lima, Quito
- 13 (GMT-05:00) Eastern Time (US & Canada)
- 14 (GMT-05:00) Indiana (East)
- 15 (GMT-04:00) Atlantic Time (Canada)
- 16 (GMT-04:00) Caracas, La Paz
- 17 (GMT-04:00) Santiago
- 18 (GMT-03:00) Newfoundland
- 19 (GMT-03:00) Brasilia
- 20 (GMT-03:00) Buenos Aires, Georgetown
- 21 (GMT-03:00) Greenland
- 22 (GMT-02:00) Mid-Atlantic
- 23 (GMT-01:00) Azores

- 24 (GMT-01:00) Cape Verde Is.
- 25 (GMT) Casablanca, Monrovia
- 26 (GMT) Greenwich Mean Time: Dublin, Edinburgh, Lisbon, London
- 27 (GMT+01:00) Amsterdam, Berlin, Bern, Rome, Stockholm, Vienna
- 28 (GMT+01:00) Belgrade, Bratislava, Budapest, Ljubljana, Prague
- 29 (GMT+01:00) Brussels, Copenhagen, Madrid, Paris
- 30 (GMT+01:00) Sarajevo, Skopje, Sofija, Vilnius, Warsaw, Zagreb
- 31 (GMT+01:00) West Central Africa
- 32 (GMT+02:00) Athens, Istanbul, Minsk
- 33 (GMT+02:00) Bucharest
- 34 (GMT+02:00) Cairo
- 35 (GMT+02:00) Harare, Pretoria
- 36 (GMT+02:00) Helsinki, Riga, Tallinn
- 37 (GMT+02:00) Jerusalem
- 38 (GMT+03:00) Baghdad
- 39 (GMT+03:00) Kuwait, Riyadh
- 40 (GMT+03:00) Moscow, St. Petersburg, Volgograd
- 41 (GMT+03:00) Nairobi
- 42 (GMT+03:30) Tehran
- 43 (GMT+04:00) Abu Dhabi, Muscat
- 44 (GMT+04:00) Baku, Tbilisi, Yerevan
- 45 (GMT+04:30) Kabul
- 46 (GMT+05:00) Ekaterinburg
- 47 (GMT+05:00) Islamabad, Karachi, Tashkent
- 48 (GMT+05:30) Calcutta, Chennai, Mumbai, New Delhi
- 49 (GMT+05:45) Kathmandu
- 50 (GMT+06:00) Almaty, Novosibirsk
- 51 (GMT+06:00) Astana, Dhaka
- 52 (GMT+06:00) Sri Jayawardenepura
- 53 (GMT+06:30) Rangoon
- 54 (GMT+07:00) Bangkok, Hanoi, Jakarta
- 55 (GMT+07:00) Krasnoyarsk
- 56 (GMT+08:00) Beijing, Chongqing, Hong Kong, Urumqi
- 57 (GMT+08:00) Irkutsk, Ulaan Bataar
- 58 (GMT+08:00) Kuala Lumpur, Singapore
- 59 (GMT+08:00) Perth
- 60 (GMT+08:00) Taipei
- 61 (GMT+09:00) Osaka, Sapporo, Tokyo

- 62 (GMT+09:00) Seoul
- 63 (GMT+09:00) Yakutsk
- 64 (GMT+09:30) Adelaide
- 65 (GMT+09:30) Darwin
- 66 (GMT+10:00) Brisbane
- 67 (GMT+10:00) Canberra, Melbourne, Sydney
- 68 (GMT+10:00) Guam, Port Moresby
- 69 (GMT+10:00) Hobart
- 70 (GMT+10:00) Vladivostok
- 71 (GMT+11:00) Magadan, Solomon Is., New Caledonia
- 72 (GMT+12:00) Auckland, Wellington
- 73 (GMT+12:00) Fiji, Kamchatka, Marshall Is.
- 74 (GMT+13:00) Nuku'alofa

**Daylight Saving Time:** Set when Enable Daylight Saving Time start and end, during the Daylight Saving Time, the device's time is one hour earlier than the actual time.

**Daylight Saving Start** and **Daylight Saving End:** the time setting allows user to selects the week that monthly basis, and sets the End and Start time individually.

Once you finish your configuration, click on **Apply** to apply your configuration.

#### 4.2.5 Jumbo Frame

##### What is Jumbo Frame?

The typical Ethernet frame is range from 64 to 1518 bytes. This is sufficient for general usages. However, when users want to transmit large files, the files may be divided into many small size packets. While the transmitting speed becomes slow, long size Jumbo frame can solve the issue.

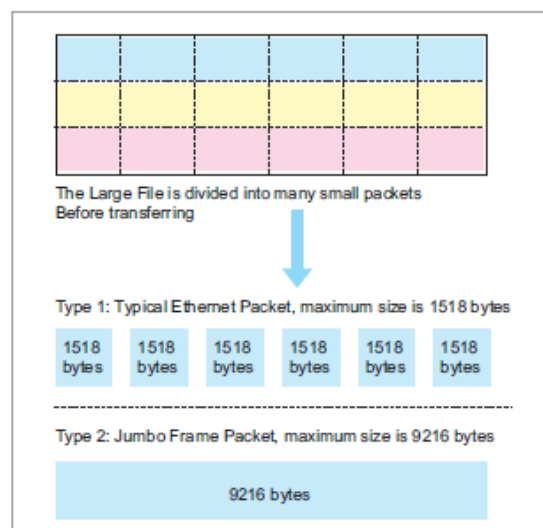

The switch allows you configure the size of the MTU, Maximum Transmission Unit. The default value is 1,518bytes. The maximum Jumbo Frame size is 9,216 bytes.

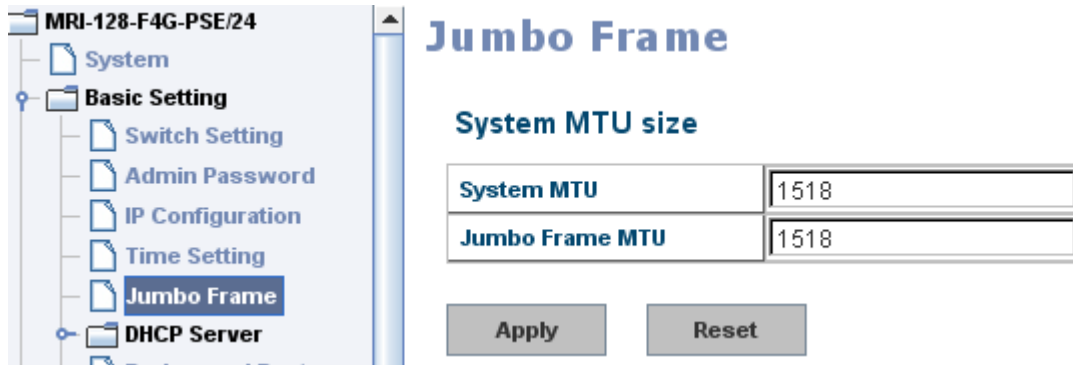

Once you finish your configuration, click on **Apply** to apply your configuration.

#### 4.2.6 DHCP Server

You can select to **Enable** or **Disable** DHCP Server function. It will assign a new IP address to link partners.

##### DHCP Server configuration

### DHCP Server Configuration

DHCP Server  ▼

#### DHCP Server Configuration

Network	<input type="text" value="192.168.2.0"/>
Subnet Mask	<input type="text" value="255.255.255.0"/>
Default Gateway	<input type="text" value="192.168.2.254"/>
Lease Time(s)	<input type="text" value="604800"/>

#### Excluded Address

IP Address

#### Excluded Address List

Index	IP Address

#### Manual Binding

IP Address

MAC Address

#### Manual Binding List

Index	IP Address	MAC Address

After selecting to enable DHCP Server function, type in the Network IP address for the DHCP server IP pool, Subnet Mask, Default Gateway address and Lease Time

for client.

Once you have finished the configuration, click **Apply** to apply your configuration

**Excluded Address:**

You can type a specific address into the **IP Address field** for the DHCP server reserved IP address.

The IP address that is listed in the **Excluded Address List Table** will not be assigned to the network device. Add or remove an IP address from the **Excluded Address List** by clicking **Add** or **Remove**.

**Manual Binding:** the switch provides a MAC address and IP address binding and removing function. You can type in the specified IP and MAC address, then click **Add** to add a new MAC&IP address binding rule for a specified link partner, like PLC or any device without **DHCP client** function. To remove from the binding list, just select the rule to remove and click **Remove**.

**DHCP Leased Entries:** *the switch* provides an assigned IP address list for user check. It will show the MAC and IP address that was assigned by *the switch*. Click the **Reload** button to refresh the listing.

### DHCP Leased Entries

Index	Binding	IP Address	MAC Address	Lease Time(s)
1	Auto	192.168.2.1	001d.725a.df26	604759

Reload

**DHCP Relay Agent:** The DHCP Relay Agent is also known as DHCP Option 82. It can help relay the DHCP Request to remote DHCP server located in different subnet.

**Note:** The DHCP Server can not work with DHCP Relay Agent at the same time.

**Relay Agent:** Choose Enable or Disable the relay agent.

**Relay Policy:** The Relay Policy is used when the DHCP request is relayed through more than one switch. The switch can drop, keep or replace the MAC address of the DHCP

### DHCP Relay Agent

**Relay Agent** Enable ▾

**Relay Policy**  Relay policy drop  
 Relay policy keep  
 Relay policy replace

Helper Address 1	<input type="text"/>
Helper Address 2	<input type="text"/>
Helper Address 3	<input type="text"/>
Helper Address 4	<input type="text"/>

Apply

Request packet.

**Helper Address:** Type the IP address of the target DHCP Server. There are 4 available IP addresses.

#### 4.2.7 Backup and Restore

With Backup command, you can save current configuration file saved in the switch's flash to admin PC or TFTP server. This will allow you to go to **Restore** command later to restore the configuration file back to the switch. Before you restore the configuration file, you must place the backup configuration file in the PC or TFTP server. The switch will then download this file back to the flash.

There are 2 modes for users to backup/restore the configuration file, Local File mode and TFTP Server mode.

**Local File** mode: In this mode, the switch acts as the file server. Users can browse the target folder and then type the file name to backup the configuration. Users can also browse the target folder and select existed configuration file to restore the configuration back to the switch. This mode is only provided by Web UI while CLI is not supported.

**TFTP Server** mode: In this mode, the switch acts as TFTP client. Before you do so, make sure that your TFTP server is ready. Then please type the IP address of TFTP Server and Backup configuration file name. This mode can be used in both CLI and Web UI.

**TFTP Server IP Address:** You need to key in the IP address of your TFTP Server here.

**Backup/Restore File Name:** Please type the correct file name of the configuration file.

**Configuration File:** The configuration file of the switch is a pure text file. You can open it by word/txt read file. You can also modify the file, add/remove the configuration settings, and then restore back to the switch.

**Startup Configuration File:** After you saved the running-config to flash, the new settings will be kept and work after power cycle. You can use *show startup-config* to view it in CLI. The Backup command can only backup such configuration file to your PC or TFTP server.

**Technical Tip:**

**Default Configuration File:** The switch provides the default configuration file in the system. You can use Reset button, Reload command to reset the system.

**Running Configuration File:** The switch's CLI allows you to view the latest settings running by the system. The information shown here is the settings you set up but haven't saved to flash. The settings not yet saved to flash will not work after power recycle. You can use show running-config to view it in CLI.

Once you finish selecting and configuring the settings, click on **Backup** or **Restore** to run

### Backup and Restore

**Backup Configuration** Local File ▼

Backup File Name  

Backup

**Restore Configuration** TFTP Server ▼

TFTP Server IP

Restore File Name

Restore



Click on Folder icon to select the target file you want to backup/restore.

**Note** that the folders of the path to the target file do not allow you to input space key.

Type the IP address of TFTP Server IP. Then click on **Backup/Restore**.

**Note:** point to the wrong file will cause the entire configuration missed

#### 4.2.8 Firmware Upgrade

In this section, you can update the latest firmware for your switch. Westermo provides the latest firmware in the Web site. The new firmware may include new features, bug fixes or other software changes. We'll also provide the release notes for the update as well. For technical viewpoint, we suggest you use the latest

firmware before installing the switch to the customer site.

**Note that the system will be automatically rebooted after you finished upgrading new firmware. Please remind the attached users before you do this.**

## Firmware Upgrade

System Firmware Version: v1.1\_beta2  
System Firmware Date: 20101018-15:19:03  
WebManager Build Date: 2010-10-18 15:40:23

**Firmware Upgrade**  ▼

**Firmware File Name**  

Note: When firmware upgrade is finished, the switch will restart automatically.

**Upgrade**

There are two modes for users to backup/restore the configuration file, Local File mode and TFTP Server mode.

**Local File** mode: In this mode, the switch acts as the file server. Users can browse the target folder and then type the file name to backup the configuration. Users also can browse the target folder and select the existed configuration file to restore the configuration back to the switch. This mode is only provided by Web UI while CLI is not supported.

**TFTP Server** mode: In this mode, the switch acts as the TFTP client. Before you do so, make sure that your TFTP server is ready. And then please type the IP address of TFTP Server IP address. This mode can be used in both CLI and Web UI.

**TFTP Server IP Address:** You need to key in the IP address of your TFTP Server here.

**Firmware File Name:** The file name of the new firmware.

The UI also shows you the current firmware version and built date of current firmware. Please check the version number after the switch is rebooted.

Before upgrading firmware, please check the file name and switch model name first and carefully. The switch provide protection when upgrading incorrect firmware file, the system would not crash even download the incorrect firmware. Even we have the protection, we still ask you don't try/test upgrade incorrect firmware, the unexpected event may occure or damage the system.

After finishing transmitting the firmware, the system will copy the firmware file and replace the firmware in the flash. The CLI show ..... until the process is finished.

#### 4.2.9 Factory Default

In this section, you can reset all the configurations of the switch to default setting. Click on **Reset** the system will then reset all configurations to default setting. The system will show you popup message window after finishing this command. Default setting will work after rebooting the switch.

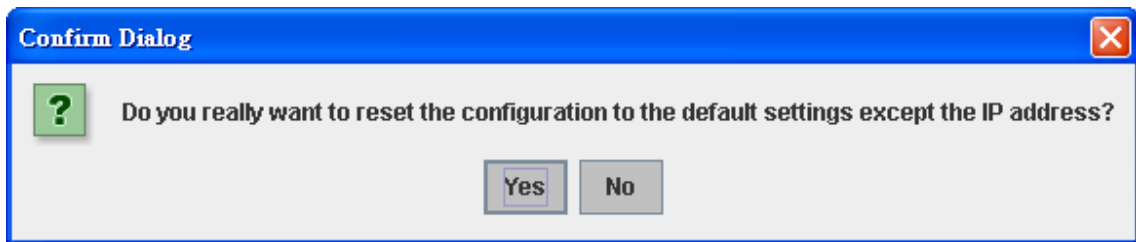

Popup alert screen to confirm the command. Click on **Yes** to start it.

Click on **OK** to close the screen. Then please go to **Reboot** page to reboot the switch.

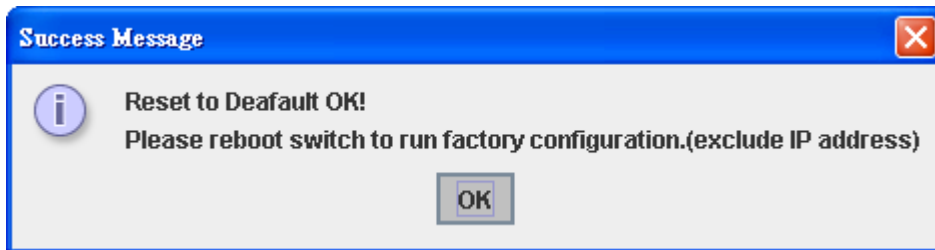

Click on **OK**. The system will then auto reboot the device.

Note: If you already configured the IP of your device to other IP address, when you use this command by CLI and Web UI, the switch will not reset the IP address to default IP. The system will remain the IP address so that you can still connect the switch via the network.

#### 4.2.10 System Reboot

System Reboot allows you to reboot the device. Some of the feature changes require you to reboot the system. Click on **Reboot** to reboot your device.

**Note:** Remember to click on **Save** button to save your settings. Otherwise, the settings you made will be gone when the switch is powered off.

Pop-up alert screen to request confirmation. Click on **Yes**. Then the switch will be rebooted immediately.

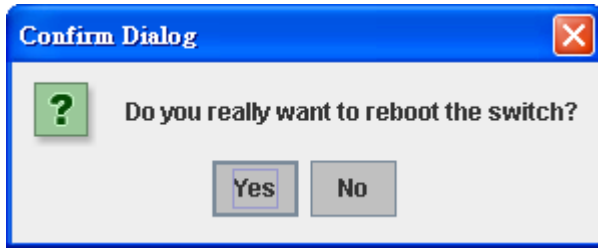

Pop-up message screen appears when rebooting the switch.

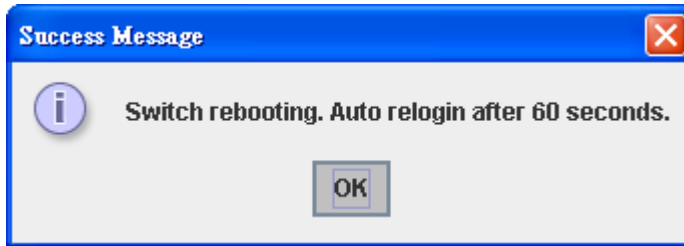

Note: Since different browser may has different behavior. If the Web GUI doesn't re-login, please manually type the IP Address and log into the switch again.

#### 4.2.11 CLI Commands for Basic Setting

Feature	Command Line
<b>Switch Setting</b>	
System Name	Switch(config)# hostname WORD Network name of this system Switch(config)# hostname SWITCH SWITCH(config)#
System Location	SWITCH(config)# snmp-server location Sweden
System Contact	SWITCH(config)# snmp-server contact support@westermo.se
Display	SWITCH# show snmp-server name SWITCH  SWITCH# show snmp-server location Sweden  SWITCH# show snmp-server contact <a href="mailto:support@westermo.se">support@westermo.se</a>

	<pre>Switch&gt; show version Loader Version : 1.0.0.3 Firmware Version : 1.1.26-20101025-10:17:48  Switch# show hardware mac MAC Address : 00:07:7c:e6:00:00  Switch# show hardware led RM : Off</pre>
<b>Admin Password</b>	
User Name and Password	<pre>SWITCH(config)# administrator NAME Administrator account name SWITCH(config)# administrator super PASSWORD Administrator account password SWITCH(config)# administrator super super Change administrator account super and password super success.</pre>
Display	<pre>SWITCH# show administrator Administrator account information name: super password: super</pre>
<b>IP Configuration</b>	
IP Address/Mask (192.168.2.8, 255.255.255.0	<pre>SWITCH(config)# int vlan 1 SWITCH(config-if)# ip address dhcp SWITCH(config-if)# ip address 192.168.2.8/24 <b>(DHCP Client)</b> SWITCH(config-if)# ip dhcp client SWITCH(config-if)# ip dhcp client renew</pre>
Gateway	<pre>SWITCH(config)# ip route 0.0.0.0/0 192.168.2.254/24</pre>
Remove Gateway	<pre>SWITCH(config)# no ip route 0.0.0.0/0 192.168.2.254/24</pre>
Display	<pre>SWITCH# show interface vlan1 interface vlan1 is up, line protocol detection is disabled index 22 metric 1 mtu 1500 &lt;...&gt; HWaddr: 00:07:7c:ff:13:57</pre>

	<pre> inet 192.168.2.8/24 broadcast 192.168.2.255 .....  SWITCH# show running-config ..... ! interface vlan1 ip address 192.168.2.8/24 no shutdown ! ip route 0.0.0.0/0 192.168.2.254/24 ! </pre>
<b>Time Setting</b>	
NTP Server	<pre> SWITCH(config)# ntp peer enable disable primary secondary SWITCH(config)# ntp peer primary IPADDR SWITCH(config)# ntp peer primary 192.168.2.200 </pre>
Time Zone	<pre> SWITCH(config)# clock timezone 26 Sun Jan 1 04:13:24 2006 (GMT) Greenwich Mean Time: Dublin, Edinburgh, Lisbon, London </pre> <p><b>Note:</b> By typing clock timezone ?, you can see the timezone list. Then choose the number of the timezone you want to select.</p>
IEEE 1588	<pre> Switch(config)# ptpd run &lt;cr&gt; preferred-clock Preferred Clock slave          Run as slave </pre>
Display	<pre> SWITCH# sh ntp associations Network time protocol Status : Disabled Primary peer : N/A </pre>

	<pre> Secondary peer : N/A  SWITCH# show clock Sun Jan 1 04:14:19 2006 (GMT) Greenwich Mean Time: Dublin, Edinburgh, Lisbon, London  SWITCH# show clock timezone clock timezone (26) (GMT) Greenwich Mean Time: Dublin, Edinburgh, Lisbon, London  Switch# show ptpd PTPd is enabled Mode: Slave </pre>
<b>Jumbo Frame</b>	
Jumbo Frame	<pre> Type the maximum MTU to enable Jumbo Frame: SWITCH(config)# system mtu &lt;64-9216&gt; bytes (with VLAN tag) Switch(config)# system mtu 9216  Disable Jumbo Frame: SWITCH(config)# no system mtu </pre>
Display	<pre> SWITCH# show system mtu System MTU size is 9216 bytes  After disabled Jumbo Frame: SWITCH# show system mtu System MTU size is 1522 bytes </pre>
<b>DHCP</b>	
DHCP Commands	<pre> Switch(config)# router dhcp Switch(config-dhcp)# default-router DHCP Default Router end Exit current mode and down to previous enable mode exit Exit current mode and down to previous mode ip IP protocol </pre>

	<pre> lease DHCP Lease Time list Print command list network dhcp network no remove quit Exit current mode and down to previous mode service enable service </pre>
DHCP Server Enable	<pre> Switch(config-dhcp)# service dhcp &lt;cr&gt; </pre>
DHCP Server IP Pool (Network/Mask )	<pre> Switch(config-dhcp)# network A.B.C.D/M network/mask ex. 10.10.1.0/24 Switch(config-dhcp)# network 192.168.2.0/24 </pre>
DHCP Server - Default Gateway	<pre> Switch(config-dhcp)# default-router A.B.C.D address Switch(config-dhcp)# default-router 192.168.2.254 </pre>
DHCP Server - lease time	<pre> Switch(config-dhcp)# lease TIME second Switch(config-dhcp)# lease 1000 (1000 second) </pre>
DHCP Server - Excluded Address	<pre> Switch(config-dhcp)# ip dhcp excluded-address A.B.C.D IP address Switch(config-dhcp)# ip dhcp excluded-address 192.168.2.20023 &lt;cr&gt; </pre>
DHCP Server - Static IP and MAC binding	<pre> Switch(config-dhcp)# ip dhcp static MACADDR MAC address Switch(config-dhcp)# ip dhcp static 0007.7c00.0001 A.B.C.D leased IP address Switch(config-dhcp)# ip dhcp static 0007.7c00.0001 192.168.2.99 </pre>
DHCP Relay - Enable DHCP Relay	<pre> Switch(config-dhcp)# ip dhcp relay information option Option82 policy Option82 Switch(config-dhcp)# ip dhcp relay information option </pre>
DHCP Relay - DHCP policy	<pre> Switch(config-dhcp)# ip dhcp relay information policy drop Relay Policy keep Drop/Keep/Replace option82 field </pre>

	<pre> replace Switch(config-dhcp)# ip dhcp relay information policy drop &lt;cr&gt; Switch(config-dhcp)# ip dhcp relay information policy keep &lt;cr&gt; Switch(config-dhcp)# ip dhcp relay information policy replace &lt;cr&gt; </pre>
DHCP Relay - IP Helper Address	<pre> Switch(config-dhcp)# ip dhcp helper-address A.B.C.D Switch(config-dhcp)# ip dhcp helper-address 192.168.2.200 </pre>
Reset DHCP Settings	<pre> Switch(config-dhcp)# ip dhcp reset &lt;cr&gt; </pre>
DHCP Server Information	<pre> Switch# show ip dhcp server statistics  DHCP Server ON Address Pool 1   network:192.168.2.0/24   default-router:192.168.2.254   lease time:604800  Excluded Address List   IP Address   -----   192.168.2.200  Manual Binding List   IP Address      MAC Address   -----   192.168.2.99   0007.7c01.0203  Leased Address List   IP Address      MAC Address      Leased Time Remains   -----   ----- </pre>

DHCP Relay Information	<pre>Switch# show ip dhcp relay  DHCP Relay Agent ON ----- IP helper-address : 192.168.2.200 Re-forwarding policy: Replace</pre>
<b>Backup and Restore</b>	
Backup Startup Configuration file	<pre>Switch# copy startup-config tftp: 192.168.2.33/default.conf Writing Configuration [OK]</pre> <p><b>Note 1:</b> To backup the latest startup configuration file, you should save current settings to flash first. You can refer to 4.12 to see how to save settings to the flash.</p> <p><i>Note 2: 192.168.2.33 is the TFTP server's IP and default.conf is name of the configuration file. Your environment may use different IP addresses or different file name. Please type target TFTP server IP or file name in this command.</i></p>
Restore Configuration	<pre>Switch# copy tftp: 192.168.2.33/default.conf startup-config</pre>
Show Startup Configuration	<pre>Switch# show startup-config</pre>
Show Running Configuration	<pre>Switch# show running-config</pre>
<b>Firmware Upgrade</b>	
Firmware Upgrade	<pre>Switch# archive download-sw /overwrite tftp 192.168.2.33 MRI-128-F4G-PSE.bin Firmware upgrading, don't turn off the switch! Tftping file MRI-128-F4G-PSE.bin Firmware upgrading ..... ..... ..... ..... .....</pre>

	Firmware upgrade success!! Rebooting.....
<b>Factory Default</b>	
Factory Default	Switch# reload default-config file Reload OK! Switch# reboot
<b>System Reboot</b>	
Reboot	Switch# reboot

## 4.3 Port Configuration

Port Configuration group enables you to enable/disable port state, or configure port auto-negotiation, speed, and duplex, flow control, rate limit control and port aggregation settings. It also allows you to view port status and aggregation information.

Following commands are included in this chapter:

- 4.3.1 Understand the port mapping
- 4.3.2 Port Control
- 4.3.3 Port Status
- 4.3.4 Rate Control
- 4.3.5 Storm Control
- 4.3.6 Port Trunking
- 4.3.7 Command Lines for Port Configuration

### 4.3.1 Port Control

Port Control commands allow you to enable/disable port state, or configure the port auto-negotiation, speed, duplex and flow control.

Port	State	Speed/Duplex	Flow Control	Description
1	Enable	Auto Negotiation	Disable	
2	Enable	Auto Negotiation	Disable	
3	Enable	Auto Negotiation	Disable	
4	Enable	Auto Negotiation	Disable	
5	Enable	Auto Negotiation	Disable	
6	Enable	Auto Negotiation	Disable	
7	Enable	Auto Negotiation	Disable	
8	Enable	Auto Negotiation	Disable	
9	Enable	Auto Negotiation	Disable	
10	Enable	Auto Negotiation	Disable	

Apply

Select the port you want to configure and make changes to the port.

In **State** column, you can enable or disable the state of this port. Once you disable, the port stop to link to the other end and stop to forward any traffic. The default setting is Enable which means all the ports are workable when you receive the device.

In **Speed/Duplex** column, you can configure port speed and duplex mode of this

port. Below are the selections you can choose:

Fast Ethernet Port 1~24 (fa1~fa24): AutoNegotiation, 10M Full Duplex(10 Full), 10M Half Duplex(10 Half), 100M Full Duplex(100 Full) and 100M Half Duplex(100 Half).

Gigabit Ethernet Port 25~28: (gi25~gi28): AutoNegotiation, 10M Full Duplex(10 Full), 10M Half Duplex(10 Half), 100M Full Duplex(100 Full), 100M Half Duplex(100 Half), 1000M Full Duplex(1000 Full), 1000M Half Duplex(1000 Half).

The default mode is Auto Negotiation mode.

In **Flow Control** column, “Symmetric” means that you need to activate the flow control function of the remote network device in order to let the flow control of that corresponding port on the switch to work. “Disable” means that you don’t need to activate the flow control function of the remote network device, as the flow control of that corresponding port on the switch will work anyway.

Once you finish configuring the settings, click on **Apply** to save the configuration.

***Technical Tips:** If both ends are not at the same speed, they can’t link with each other. If both ends are not in the same duplex mode, they will be connected by half mode.*

### 4.3.2 Port Status

Port Status shows you current port status.

It also shows you the port status of the Gigabit Ethernet Ports, ex: Gigabit SFP Port 25, 26, 27 and 28. Also, it supports Small Form Factory (SFP) fiber transceiver with Digital Diagnostic Monitoring (DDM) function that provides real time information of SFP transceiver and allows user to diagnostic the optical fiber signal received and launched.

## Port Status

Port	Type	Link	State	Speed/Duplex	Flow Control	SFP Vendor	Wavelength	Distance
1	100BASE-TX	Up	Enable	100 Full	Disable			--
2	100BASE-TX	Up	Enable	100 Full	Disable			--
3	100BASE-TX	Down	Enable	--	Disable			--
4	100BASE-TX	Down	Enable	--	Disable			--
5	100BASE-TX	Down	Enable	--	Disable			--
6	100BASE-TX	Down	Enable	--	Disable			--
7	100BASE-TX	Down	Enable	--	Disable			--
8	1000BASE	Down	Enable	--	Disable	--	--	--
9	1000BASE	Down	Enable	--	Disable	--	--	--
10	1000BASE	Down	Enable	--	Disable	--	--	--

### SFP DDM

Port	Remove	Temperature (°C)		Tx Power (dBm)		Rx Power (dBm)	
		Current	Range	Current	Range	Current	Range
8	Eject	--	--	--	--	--	--
9	Eject	--	--	--	--	--	--
10	Eject	--	--	--	--	--	--

Reload

Eject All

The description of the columns is as below:

**Port:** Port interface number.

**Type:** 100TX -> Fast Ethernet port. 1000TX -> Gigabit Ethernet port.

**Link:** Link status. Up -> Link UP. Down -> Link Down.

**State:** Enable -> State is enabled. Disable -> The port is disable/shutdown.

**Speed/Duplex:** Current working status of the port.

**Flow Control:** The state of the flow control.

**SFP Vendor:** Vendor name of the SFP transceiver you plugged.

**Wavelength:** The wave length of the SFP transceiver you plugged.

**Distance:** The distance of the SFP transceiver you plugged.

**Eject:** Eject the DDM SFP transceiver. You can eject one port or eject all by click the icon "Eject All".

**Temperature:** The temperature specific and current detected of DDM SFP transceiver.

**Tx Power (dBm):** The specification and current transmit power of DDM SFP transceiver.

**Rx Power (dBm):** The specification and current received power of DDM SFP transceiver.

**Note:**

**1. Most of the SFP transceivers provide vendor information which allows your switch to read it. The User Interface can display vendor name, wave length and**

distance of all Westermo SFP transceiver family. If you see Unknown info, it may mean that the vendor doesn't provide their information or that the information of their transceiver can't be read.

2. If the plugged DDM SFP transceiver is not certified by Westermo, the DDM function will not be supported. But the communication will not be disabled.

### 4.3.3 Rate Control

Rate limiting is a form of flow control used to enforce a strict bandwidth limit at a port. You can program separate transmit (Egress Rule) and receive (Ingress Rule) rate limits at each port, and even apply the limit to certain packet types as described below.

Figure shows you the Limit Rate of Ingress and Egress. You can type the volume step by 64Kbps in the blank.

### Rate Control

Limit Packet Type and Rate

Port	Ingress Rate(Kbps)	Egress Rate(Kbps)
1	0	0
2	0	0
3	0	0
4	0	0
5	0	0
6	0	0
7	0	0
8	0	0
9	0	0
10	0	0

Apply

### 4.3.4 Storm Control

The Storm Control is similar to Rate Control. Rate Control filters all the traffic over the threshold you input by User Interface. Storm Control allows user to define the rate for specific Packet Types.

## Storm Control

Port	Broadcast	Rate (packet/sec)	DLF	Rate (packet/sec)	Multicast	Rate (packet/sec)
1	Disable	0	Disable	0	Disable	0
2	Disable	0	Disable	0	Disable	0
3	Disable	0	Disable	0	Disable	0
4	Disable	0	Disable	0	Disable	0
5	Disable	0	Disable	0	Disable	0
6	Disable	0	Disable	0	Disable	0
7	Disable	0	Disable	0	Disable	0
8	Disable	0	Disable	0	Disable	0
9	Disable	0	Disable	0	Disable	0
10	Disable	0	Disable	0	Disable	0

Apply

**Packet type:** You can assign the Rate for specific packet types based on packet number per second. The packet types of the Ingress Rule listed here include **Broadcast, DLF (Destination Lookup Failure) and Multicast**. Choose **Enable/Disable** to enable or disable the storm control of specific port.

**Rate:** This column allows you to manually assign the limit rate of the port. The unit is packets per second. The limit range is from 1 to 262143 packet/sec, zero means no limit. The maximum available value of Fast Ethernet interface is 148810, this is the maximum packet number of the 100M throughput.

Enter the Rate field of the port you want assign, type in the new value and then press on the Enter key first. After assigned or changed the value on all the ports you want to configure. [Click on Apply to apply the configuration of all ports. The Apply command applied all the ports' storm control value](#)

### 4.3.5 Port Trunking

Port Trunking configuration allows you to group multiple Ethernet ports in parallel to increase link bandwidth. The aggregated ports can be viewed as one physical port so that the bandwidth is higher than merely one single Ethernet port. The member ports of the same trunk group can balance the loading and backup for each other. Port Trunking feature is usually used when you need higher bandwidth for backbone network. This is an inexpensive way for you to transfer more data.

There are some different descriptions for the port trunking. Different

manufacturers may use different descriptions for their products, like Link Aggregation Group (LAG), Link Aggregation Control Protocol, Ethernet Trunk, Ether Channel...etc. Most of the implementations now conform to IEEE standard, 802.3ad.

The aggregated ports can interconnect to the other switch which also supports Port Trunking. Westermo Supports 2 types of port trunking. One is Static Trunk, the other is 802.3ad. When the other end uses 802.3ad LACP, you **should** assign 802.3ad LACP to the trunk. When the other end uses non-802.3ad, you can then use Static Trunk.

There are two configuration pages, Aggregation Setting and Aggregation Status.

### Aggregation Setting

#### Port Trunk - Aggregation Setting

Port	Group ID	Trunk Type
1	None	Static
2	None	Static
3	None	Static
4	None	Static
5	None	Static
6	None	Static
7	None	Static
8	None	Static
9	None	Static
10	None	Static

Trunk ID	Load Balance Type
Trunk 1	src-dst-mac
Trunk 2	src-dst-mac
Trunk 3	src-dst-mac
Trunk 4	src-dst-mac
Trunk 5	src-dst-mac
Trunk 6	src-dst-mac
Trunk 7	src-dst-mac
Trunk 8	src-dst-mac

Note: The port parameters of the trunk members should be the same.

Apply

**Trunk Size:** The switch can support up to 8 trunk groups and. eEach trunk group can support up to 8 member ports. Since the member ports should use same speed/duplex, max groups for 100M ports would be 7 groups, and 3 groups for gigabit ports.

**Group ID:** Group ID is the ID for the port trunking group. Ports with same group ID are in the same group.

**Trunk Type: Static and 802.3ad LACP.** Each Trunk Group can only support Static or 802.3ad LACP. Choose the type you need here.

**Load Balance Type:** There is several load balance types based on dst-ip (Destination IP), dst-mac (Destination MAC), src-dst-ip (Source and Destination IP), src-dst-mac (Source and Destination MAC), src-ip (Source IP), src-mac (Source MAC).

Trunk ID	Load Balance Type
Trunk 1	src-dst-mac
Trunk 2	dst-ip
Trunk 3	dst-mac
Trunk 4	src-dst-ip
Trunk 5	src-dst-mac
Trunk 6	src-ip
Trunk 7	src-mac
Trunk 8	src-dst-mac

### Aggregation Status

This page shows the status of port aggregation. Once the aggregation ports are negotiated well, you will see following status.

### Port Trunk - Aggregation Information

Group ID	Type	Aggregated Ports	Individual Ports	Link Down Ports	Load Balance
Trunk 1					
Trunk 2					
Trunk 3					
Trunk 4					
Trunk 5					
Trunk 6					
Trunk 7					
Trunk 8					

Reload

**Group ID:** Display Trunk 1 to Trunk 8 set up in Aggregation Setting.

**Type:** Static or LACP set up in Aggregation Setting.

**Aggregated Ports:** When the LACP links is up, you can see the member ports in Aggregated column.

**Individual Ports:** When LACP is enabled, member ports of LACP group which are not connected to correct LACP member ports will be displayed in the Individual column.

**Link Down Ports:** When LACP is enabled, member ports of LACP group which are not linked up will be displayed in the Link Down column.

**Load Balance:** There are several load balance types based on dst-ip (Destination IP), dst-mac (Destination MAC), src-dst-ip (Source and Destination IP), src-dst-mac

(Source and Destination MAC), src-ip (Source IP), src-mac (Source MAC).

#### 4.3.6 Command Lines for Port Configuration

Feature	Command Line
<b>Port Control</b>	
Port Control - State	<pre>Switch(config-if)# shutdown          -&gt; Disable port state Port1 Link Change to DOWN interface fastethernet1 is shutdown now.  Switch(config-if)# no shutdown      -&gt; Enable port state Port1 Link Change to DOWN Port1 Link Change to UP interface fastethernet1 is up now. Switch(config-if)# Port1 Link Change to UP  Switch(config)# sfp ddm Digital diagnostic and monitoring Switch(config)# sfp ddm Eject Reject DDM SFP Switch(config)# sfp ddm eject → eject SFP DDM transceiver all All DDM interface Example: Switch(config)# sfp ddm eject all         DDM SFP on Port 9 normally ejected.         DDM SFP on Port 9 normally ejected.         All DDM SFP normally ejected.  Switch(config)# interface gigabitethernet10 → eject port 10 SFP DDM transceiver. Switch(config-if)# sfp ddm eject DDM SFP on Port 10 normally ejected.</pre>
Port Control - Auto Negotiation	<pre>Switch(config)# interface fa1 Switch(config-if)# auto-negotiation Auto-negotiation of port 1 is enabled!</pre>

Port Control - Force Speed/Duple x	Switch(config-if)# speed 100 Port1 Link Change to DOWN set the speed mode ok! Switch(config-if)# Port1 Link Change to UP  Switch(config-if)# duplex full Port1 Link Change to DOWN set the duplex mode ok! Switch(config-if)# Port1 Link Change to UP
Port Control - Flow Control	Switch(config-if)# flowcontrol on Flowcontrol on for port 1 set ok!  Switch(config-if)# flowcontrol off Flowcontrol off for port 1 set ok!
<b>Port Status</b>	
Port Status	Switch# show interface fal Interface fastethernet1 Administrative Status : Enable Operating Status : Connected Duplex : Full Speed : 100 Flow Control :off Default Port VLAN ID: 1 Ingress Filtering : Disabled Acceptable Frame Type : All Port Security : Disabled Auto Negotiation : Disable Loopback Mode : None STP Status: forwarding Default CoS Value for untagged packets is 0. Mdix mode is Disable. Medium mode is Copper.  Switch# show sfp ddm →show SFP DDM information Port 8 Temperature:N/A

	<p>Tx power:N/A</p> <p>Rx power:N/A</p> <p>Port 9</p> <p>Temperature:64.00 C &lt;range :0.0-80.00&gt;</p> <p>Tx power:-6.0 dBm &lt;range : -9.0 - -4.0&gt;</p> <p>Rx power:-30.0 dBm &lt;range: -30.0 - -4.0&gt;</p> <p>Port 10</p> <p>Temperature:67.00 C &lt;range :0.0-80.00&gt;</p> <p>Tx power:-6.0 dBm &lt;range : -9.0 - -4.0&gt;</p> <p>Rx power:-2.0 dBm &lt;range: -30.0 - -4.0&gt;</p> <p><i>Note: Administrative Status -&gt; Port state of the port. Operating status -&gt; Current status of the port. Duplex -&gt; Duplex mode of the port. Speed -&gt; Speed mode of the port. Flow control -&gt; Flow Control status of the port.</i></p>
<b>Rate Control</b>	
Rate Control - Ingress or Egress	<p>Switch(config-if)# rate-limit</p> <p>egress   Outgoing packets</p> <p>ingress   Incoming packets</p> <p><b>Note: To enable rate control, you should select the Ingress or Egress rule first; then assign the packet type and bandwidth.</b></p>
Rate Control - Filter Packet Type	<p>Switch(config-if)# rate-limit ingress mode</p> <p>all           Limit all frames</p> <p>broadcast     Limit Broadcast frames</p> <p>flooded-unicast   Limit Broadcast, Multicast and flooded unicast frames</p> <p>multicast     Limit Broadcast and Multicast frames</p> <p>Switch(config-if)# rate-limit ingress mode broadcast</p> <p>Set the ingress limit mode broadcast ok.</p>
Rate Control - Bandwidth	<p>Switch(config-if)# rate-limit ingress bandwidth</p> <p>&lt;0-100&gt;   Limit in magabits per second (0 is no limit)</p> <p>Switch(config-if)# rate-limit ingress bandwidth 8</p> <p>Set the ingress rate limit 8Mbps for Port 1.</p>
<b>Storm Control</b>	
Strom	Switch(config-if)# storm-control

Control - Packet Type	<pre> broadcast :Broadcast packets dlf :Destination Lookup Failure multicast :Multicast packets </pre>
Storm Contr-1 - Rate	<pre> Switch(config)# storm-control broadcast &lt;0-100000&gt; Rate limit value 0~262143 packet/sec Switch(config)# storm-control broadcast 10000 limit_rate = 10000 packets/sec Set rate limit for Broadcast packets. Switch(config)# storm-control multicast 10000 limit_rate = 10000 packets/sec Set rate limit for Multicast packets. Switch(config)# storm-control dlf 10000 limit_rate = 10000 packets/sec Set rate limit for Destination Lookup Failure packets. </pre>
<b>Port Trunking</b>	
LACP	<pre> Switch(config)# lacp group 1 gi25-27 Group 1 based on LACP(802.3ad) is enabled!  Note: The interface list is fa1,fa3-5,gi25-27 Note: different speed port can't be aggregated together. </pre>
Static Trunk	<pre> Switch(config)# trunk group 2 fa6-7 Trunk group 2 enable ok! </pre>
Display - LACP	<pre> etNet 5728G# show lacp internal LACP group 1 internal information:       LACP Port  Admin   Oper    Port Port  Priority  Key     Key     State -----       8          1       8       8     0x45       9          1       9       9     0x45      10          1      10      10     0x45  LACP group 2 is inactive LACP group 3 is inactive LACP group 4 is inactive </pre>
Display - Trunk	<pre> Switch# show trunk group 1 FLAGS:      I -&gt; Individual          P -&gt; In channel            D -&gt; Port Down </pre>

```
Trunk Group
GroupID Protocol Ports
-----+-----+-----
---
1      LACP      8(D) 9(D) 10(D)
Switch# show trunk group 2
FLAGS:   I -> Individual      P -> In channel
         D -> Port Down

Trunk Group
GroupID Protocol Ports
-----+-----+-----
---
2      Static    6(D) 7(P)
Switch#
```

## **4.4 Power over Ethernet**

Power over Ethernet is one of the key features of the switch. It is fully IEEE802.3af-2003 compliant, and support IEEE802.3at, including 2-event and LLDP classification.

The following commands are included in this section:

### **4.4.1 PoE Control**

### **4.4.2 Emergency Power Management**

### **4.4.3 PD Status Detection**

### **4.4.4 PoE Scheduling**

### **4.4.5 PoE Status**

### **4.4.6 Command Line for PoE control**

### **4.4.1 PoE Control**

In WiMax systems, Wireless APs, and high-end PoE applications, there are various types of PDs, for instance, IEEE 802.3af, IEEE 802.3at 2-event, IEEE 802.3at LLDP, and non-standard type. To be compatible with different PDs, it is the world's first rackmount High Power PoE switch, designed with 4 powering modes, including IEEE 802.3af mode, IEEE 802.3at 2-event mode, IEEE 802.3at LLDP classification mode as well as forced powering mode to meet all of the PD types in the industry. As a result, they can be flexibly used to deliver power for different PoE-enabled devices in various applications.

**Power over Ethernet Control**

PoE System:

Power	Budget(W)	Voltage(V)
DC 1	<input type="text" value="0"/>	<input type="text" value="53"/>
DC 2	<input type="text" value="0"/>	<input type="text" value="53"/>

Warning Water Level(%):

**Port Configuration**

Port	PoE Mode	Powering Mode	Power Budget(W)	Power Priority
1	Disable	802.3af	32.0	Critical
2	Disable	802.3af	32.0	Critical
3	Disable	802.3af	32.0	Critical
4	Disable	802.3af	32.0	Critical
5	Disable	802.3af	32.0	Critical
6	Disable	802.3af	32.0	Critical
7	Disable	802.3af	32.0	Critical
8	Disable	802.3af	32.0	Critical

As shown in the above picture, you can enable/disable the PoE function and configure the power budget and voltage of DC Power 1 and DC Power 2. The valid range of budget is 0 – 480 Watts (default is 0, and 0 mean power is disable). The valid range of power voltage is 46 - 57 V (default is 53 V). And the default power budget of inside AC power supply is 300 Watts and 53 V. Warning Water Level is used for power utilization monitoring, (valid range is 0 – 100 %, and 0 mean function is disable) If the power utilization using is more than this water level, the warning event will happen.

Pull down the **PoE Mode** column to enable/disable ports, or set it to scheduling control mode.

Pull down the **Powering Mode** column can change the Powering Mode to IEEE 802.3af, 802.3at(LLDP), 802.3at(2-Event) or forced mode. When the column is IEEE 802.3af, if and only if the PD is follow IEEE 802.3af then the switch could deliver power. If the Powering mode is 802.3at (LLDP) or 802.3at(2-Event), the switch would deliver power to PD that supports IEEE 802.3at LLDP or 2-Event feature. But if the Powering Mode changes to forced mode, once the PoE mode are enabled, the port will directly deliver power even if there is no Ethernet cable plugged.

IEEE 802.3at LLDP provides smart power budget control behavior to fulfill the needs of higher end setups requiring exact high power delivery. By using the ongoing dynamic re-negotiation function of the IEEE802.3at LLDP, the switch can perform more intelligently by dynamically reallocating power to the PDs. The switch implements the 2-event and Link Layer Discovery Protocol (LLDP) PoE into the system for efficient power budget negotiation between PSE and PD devices.

The **Power Budget** can limit the consumption of PoE port and ensure the PoE port can still get the pre-allocated power from the budget. The range of Power Budget is 0.4 to 32 Watt. The max effective power budget of 802.3af powering mode is 15.4 Watt even if the power budget is set to 32 Watts.

**Power Priority** lets the PoE port with higher priority to deliver power during the limit power budget. There are three priorities (Critical, High and Low).

After configuring, please click the **Apply** button to enable and perform the configurations.



***DO NOT TOUCH DEVICE SURFACE DURING  
PoE PROGRESS HIGH POWER FEEDING***

Next, we illustrate how to configure IEEE 802.3at LLDP. Assume the PD is ready to the configuration for IEEE 802.3at LLDP, we only need to confirm the switch configuration.

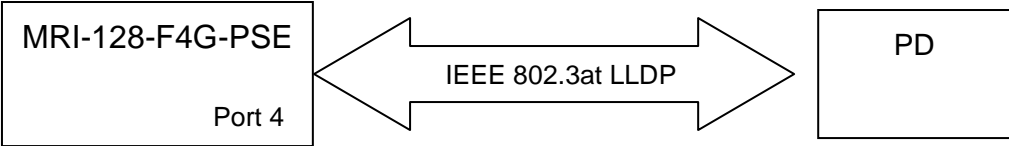

Enable the LLDP (refer to 4.12.5). By the port of the switch connected to the PD (ex. Port 4), set **PoE Mode** is **Enable** and **Powering Mode** is **802.3at(LLDP)**. When the switch and the PD are ready to IEEE802.3at LLDP, IEEE 802.3at LLDP starts operation. Finally, see the result on **Poe Status** (refer to 4.4.5).

#### 4.4.2 Emergency Power Management

The switch is equipped with dual 48VDC power inputs for providing true network redundancy. An alarm relay output signals when a power input fails or other critical events occur. To ensure reliable power delivery, other advanced PoE power management features include individual port status monitoring, emergency power management (3 power supply indication inputs for quick shutdown of ports according to pre-defined priority table in cases where power supply failure occurs) and voltage/current monitoring and regulation. Power management allows the switch to determine the exact power draw per port and to balance each port PoE power output accordingly. This, in turn, allows the switch to power higher and lower wattage devices according to user-definable parameters such as maximum available power, port priority (critical, high, low), and maximum allowable power per port. For the same level priority, the priority order is decided by port number. The port number sequence of MRI-128-F4G-PSE/24 from high priority to low priority is 3-4-1-2-7-8-5-6-11-12-9-10-15-16-13-14-19-20-17-18-23-24-21-22-27-28-25-26.

#### 4.4.3 PD Status Detection

The switch delivers a useful function – PD Status Detection. This provides automatic detection of a remote device powered by the switch. If the remote system crashes or is unstable, the switch will perform a system reboot by turning off and on again to trigger the remote device. The following figure shows the Web configure interface for Power over Ethernet PD Status Detection.

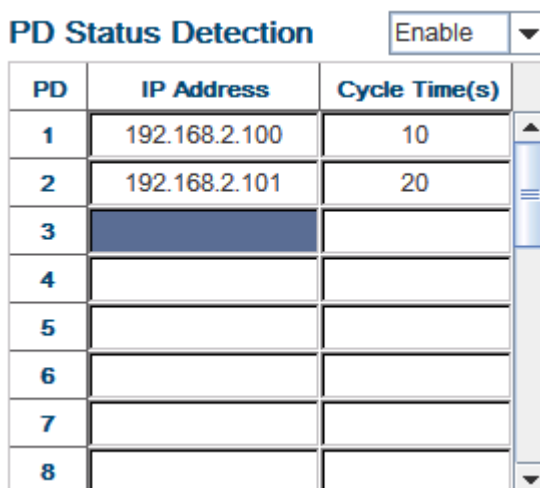

The screenshot shows the 'PD Status Detection' configuration page. At the top right, there is a dropdown menu set to 'Enable'. Below it is a table with three columns: 'PD', 'IP Address', and 'Cycle Time(s)'. The table has 8 rows. The first row has PD 1, IP Address 192.168.2.100, and Cycle Time 10. The second row has PD 2, IP Address 192.168.2.101, and Cycle Time 20. The third row has PD 3 and is highlighted in blue. The remaining rows (4-8) are empty. A vertical scrollbar is visible on the right side of the table.

PD	IP Address	Cycle Time(s)
1	192.168.2.100	10
2	192.168.2.101	20
3		
4		
5		
6		
7		
8		

You can enable/disable PD Status Detection function and type in the IP address that you want to detect. The **Cycle Time** is the gap per detection. After configuring, please click the **Apply** button to enable and perform the functions.

#### 4.4.4 PoE Scheduling

The PoE Scheduling control is a powerful function which helps you to save power and money. You need to configure **PoE Scheduling** and select a target port manually to enable this function.

### Power over Ethernet Schedule

PoE Schedule on  is **Enabled**

Time	Sunday	Monday	Tuesday	Wednesday	Thursday	Friday	Saturday
00:00							
01:00							
02:00							
03:00							
04:00							
05:00							
06:00							
07:00							
08:00							
09:00		■	■				
10:00		■	■				
11:00		■	■				
12:00		■	■				
13:00		■	■				
14:00		■	■				
15:00		■	■				
16:00		■	■				
17:00		■	■				
18:00		■	■				
19:00							
20:00							
21:00							
22:00							
23:00							

#### 4.4.5 PoE Status

The PoE Status page shows the operating status of each power and each PoE Port. The power information includes power input voltage, budget, power aggregation, redundancy status, Total Power budget, Total Output Power, Warning Water Level and Utilization. The PoE Port information includes PoE mode, Operation status, PD class, Power Consumption, Voltage and Current.

Power aggregation: if the powers are in the same priority level (primary, secondary or tertiary), the powers will be aggregated. Use the same voltage power will become power aggregation.

Power redundancy: if the powers are in the different priority level, the secondary power will be backup power for primary. The tertiary power will be backup power for primary or secondary.

## Power over Ethernet Status

<b>DC1 Power</b>	53 V, Budget 0 W
<b>DC2 Power</b>	53 V, Budget 0 W
<b>AC Power</b>	53 V, Budget 300 W
<b>Primary Power</b>	DC1(53 V), DC2(53 V), AC(53 V)
<b>Secondary Power</b>	N/A
<b>Tertiary Power</b>	N/A
<b>Total Power Budget</b>	300 W
<b>Total Output Power</b>	0.0 W
<b>Warning Water Level</b>	N/A
<b>Utilization</b>	0 %

Port	PoE Mode	Operation Status	PD Class	Consumption(W)	Voltage(V)	Current(mA)
1	Disable	Off	N/A	0.0	0.0	0
2	Disable	Off	N/A	0.0	0.0	0
3	Schedule	Off	N/A	0.0	0.0	0
4	Disable	Off	N/A	0.0	0.0	0
5	Disable	Off	N/A	0.0	0.0	0
6	Disable	Off	N/A	0.0	0.0	0
7	Disable	Off	N/A	0.0	0.0	0
8	Disable	Off	N/A	0.0	0.0	0

### 4.4.6 Command Line for PoE control

<b>Syntax</b>	<b>show poe system</b>
<b>Parameters</b>	--
<b>Command Mode</b>	Enable mode
<b>Description</b>	Display the status of the PoE system.
<b>Examples</b>	<pre>Switch&gt; enable Switch# show poe system PoE System   PoE Admin : Enable   PoE Hardward : Normal   PoE Input Voltage :     Vmain 1 : 52.8 V     Vmain 2 : 53.0 V     Vmain 3 : 52.5 V   Ouput power : 0.0 Watts   Temperature 1 : 39 degree</pre>

	<p>Temperature 2 : 41 degree  Temperature 3 : 47 degree  Power information :  Budget :  DC Power 1 : 400 Watts (In Use)  DC Power 2 : 400 Watts  AC Power : 300 Watts (In Use)  Total : 1100 Watts  700 Watts in Use  Warning water level : N/A  Utilization : 0 %  Event : Normal</p>
<b>Syntax</b>	<b>show poe interface</b> IFNAME
<b>Parameters</b>	IFNAME : interface name
<b>Command Mode</b>	Enable mode
<b>Description</b>	Display the PoE status of interface.
<b>Examples</b>	<pre>Switch&gt; enable Switch# show poe interface fa1 Interface fastethernet1 (POE Port 1)   Control Mode : User (Disable)   Powering Mode : 802.3af   Operation Status : Off   Detection Status : Valid   Classification : N/A   Priority : Highest   Output Power : 0.0 Watts, Voltage : 0.0 V, Current : 0 mA   Power Budget :     Budget : 32.0 Watts, effective 0 Watts     Warning water level : N/A     Utilization : 0 %     Event : Normal</pre>
<b>Syntax</b>	<b>show poe pd_detect</b>
<b>Parameters</b>	--
<b>Command Mode</b>	Enable mode
<b>Description</b>	Display the status of pd status detection.
<b>Examples</b>	<pre>Switch# show poe pd-detect PD Status Detection</pre>

	Status : Enabled Host 1 : Target IP : 192.168.2.100 Cycle Time : 10 Host 2 : Target IP : 192.168.2.200 Cycle Time : 20 Host 3 : Target IP : 192.168.2.15 Cycle Time : 30 Host 4 : Target IP : 192.168.2.20 Cycle Time : 40
<b>Syntax</b>	<b>show poe schedule IFNAME</b>
<b>Parameters</b>	IFNAME : interface name
<b>Command Mode</b>	Enable mode
<b>Description</b>	Display the status of schedule of interface.
<b>Examples</b>	Switch# show poe schedule fa1 Interface fastethernet1 POE Schedule Status : Disable Weekly Schedule : Sunday : 0,1,2,3,4,5,6,7,8,19,20,21,22,23 Monday : 0,1,2,3,4,5,6,7,8,19,20,21,22,23 Tuesday : 0,1,2,3,4,5,6,7,8,19,20,21,22,23 Wednesday : 0,1,2,3,4,5,6,7,8,19,20,21,22,23 Thursday : 0,1,2,3,4,5,6,7,8,19,20,21,22,23 Friday : 0,1,2,3,4,5,6,7,8,19,20,21,22,23 Saturday : 0,1,2,3,4,5,6,7,8,9,10,11,12,13,14,15,16,17,18,19,20
<b>Syntax</b>	<b>poe powering-mode 802.3af/forced</b>
<b>Parameters</b>	802.3af: deliver power if and only if the attached PD comply with IEEE 802.3af forced: deliver power no matter what PD attached
<b>Command Mode</b>	Interface mode
<b>Description</b>	Set the Powering mode of PoE
<b>Examples</b>	EX 1: <i>Set 802.3af powering mode</i> Switch(config)# poe powering-mode 802.3af

	EX 2: <i>Set forced powering mode</i> Switch(config)# poe powering-mode forced
<b>Syntax</b>	<b>poe powering-mode 802.3at 2-event/lldp</b>
<b>Parameters</b>	2-event: deliver power if and only if the attached PD comply with IEEE 802.3at physical layer classification lldp: deliver power if and only if the attached PD comply with IEEE 802.3at data link layer classification
<b>Command Mode</b>	Interface mode
<b>Description</b>	Set the Powering mode of PoE
<b>Examples</b>	EX 1: <i>Set 802.3at 2-event powering mode</i> Switch(config)# poe powering-mode 802.3at 2-event EX 2: <i>Set 802.3at lldpforced powering mode</i> Switch(config)# poe powering-mode 802.3at lldp
<b>Syntax</b>	<b>poe control-mode user/schedule</b>
<b>Parameters</b>	user: user mode schedule: schedule mode
<b>Command Mode</b>	Interface mode
<b>Description</b>	Set the control mode of port
<b>Examples</b>	Set PoE port 2 to user mode. EX 1: Switch(config)# interface fa2 Switch(config-if)# poe control-mode user Set PoE port 2 to schedule mode. EX 2: Switch(config-if)# poe control-mode schedule
<b>Syntax</b>	<b>poe user enable/disable</b>
<b>Parameters</b>	enable: enable port in user mode disable: disable port in user mode
<b>Command Mode</b>	Interface mode
<b>Description</b>	Enable/Disable the PoE of the port in user mode. If in schedule mode, it will come into affect when the control mode changes to user mode.
<b>Examples</b>	To enable the PoE function in user mode Switch(config-if)# poe user enable To disable the PoE function in user mode Switch(config-if)# poe user disable
<b>Syntax</b>	<b>poe type TYPE</b>
<b>Parameters</b>	TYPE: port type string with max 20 characters

<b>Command Mode</b>	Interface mode
<b>Description</b>	Set the port type string.
<b>Examples</b>	Set the type string to "IPCam-1. Switch(config-if)# poe type IPCam-1
<b>Syntax</b>	<b>poe budget [POWER]</b>
<b>Parameters</b>	POWER : 0.4 – 32
<b>Command Mode</b>	Interface mode
<b>Description</b>	Set the port budget. The max budget is different between 802.3af, 802.3at and forced powering mode. The max budget of 802.3af powering mode is 15.4. The max budget of 802.3at powering mode is 32. The max budget of force powering mode is 32.
<b>Examples</b>	Set the max value of power consumption to 12 W with manual mode. Switch(config-if)# poe budget 12
<b>Syntax</b>	<b>poe budget warning &lt;0-100&gt;</b>
<b>Parameters</b>	<0-100> 0 is disable, valid range is 1 to 100 percentage
<b>Command Mode</b>	Interface mode
<b>Description</b>	Set the warning water level of port budget.
<b>Examples</b>	Set the warning water level to 60% Switch(config-if)# poe budget warning 60
<b>Syntax</b>	<b>poe priority critical/high/low</b>
<b>Parameters</b>	Critical : Highest priority level High : High priority level Low : Low priority level
<b>Command Mode</b>	Interface mode
<b>Description</b>	Set the powering priority. The port with higher priority will have the privilege to delivery power under limited power situation.
<b>Examples</b>	Set the priority to critical Switch(config-if)# poe priority critical
<b>Syntax</b>	<b>poe schedule weekday hour</b>
<b>Parameters</b>	Weekday : Valid range 0-6 (0=Sunday, 1=Monday, ..., 6=Saturday) Hour : Valid range 0-23, Valid format a,b,c-d
<b>Command Mode</b>	Interface mode
<b>Description</b>	Add a day schedule to an interface.

<b>Examples</b>	Add a schedule which enables PoE function at hour 1, 3, 5 and 10 to 23 on Sunday. Switch(config-if)# poe schedule 0 1,3,5,10-23
<b>Syntax</b>	<b>no poe schedule</b> weekday
<b>Parameters</b>	Weekday : Valid range 0-6 (0=Sunday, 1=Monday, ..., 6=Saturday)
<b>Command Mode</b>	Interface mode
<b>Description</b>	Remove a day schedule
<b>Examples</b>	Remove the Sunday schedule. Switch(config-if)# no poe schedule 0
<b>Syntax</b>	<b>poe budget DC1/DC2 [POWER]</b>
<b>Parameters</b>	DC1 : DC 1 power input DC2 : DC 2 power input POWER : 1 – 480
<b>Command Mode</b>	Configuration mode
<b>Description</b>	Set the power budget of DC1 or DC2
<b>Examples</b>	Set the power budget of DC1 to 480W Switch(config)# poe budget DC1 480
<b>Syntax</b>	<b>poe budget warning &lt;0-100&gt;</b>
<b>Parameters</b>	<0-100> 0 is disable, valid range is 1 to 100 percentage
<b>Command Mode</b>	Configuration mode
<b>Description</b>	Set the warning water level of total power budget.
<b>Examples</b>	Set the warning water level to 60% Switch(config-if)# poe budget warning 60
<b>Syntax</b>	<b>poe pd_detect enable/disable</b>
<b>Parameters</b>	enable: enable PD Status Detection function disable: disable PD Status Detection function
<b>Command Mode</b>	Configuration mode
<b>Description</b>	Enable/Disable the PD Status Detection function
<b>Examples</b>	To enable the function of pd status detect function Switch(config)# poe pd_detect enable To disable the function of pd status detect function Switch(config)# poe pd_detect disable
<b>Syntax</b>	<b>poe pd_detect ip_address cycle_time</b>
<b>Parameters</b>	IP address : A.B.C.D Cycle time : Valid range 10-3600 second and must be multiple of 10
<b>Command Mode</b>	Configuration mode

<b>Description</b>	Apply a rule of PD Status Detection.
<b>Examples</b>	Apply a rule which ping 192.160.1.2 per 20 seconds. And if 192.160.1.2 is timeout, pd status detection will re-enable the PoE. Switch(config)# poe pd_detect 192.160.1.2 20

## 4.5 Network Redundancy

The switch firmware supports standard RSTP, MSTP, Multiple Super Ring, and Rapid Dual Homing.

Multiple Spanning Tree Protocol (MSTP) is a direct extension of RSTP. It can provide an independent spanning tree for different VLANs. It simplifies network management, provides for even faster convergence than RSTP by limiting the size of each region, and prevents VLAN members from being segmented from the rest of the group (as sometimes occurs with IEEE 802.1D STP).

Multiple Super Ring (MSR) technology supports 0 milliseconds for restore and less than 300 milliseconds for failover.

Advanced Rapid Dual Homing (RDH) technology also facilitates the switch to connect with a core managed switch easily and conveniently. With RDH technology, you can also group several Rapid Super Rings or RSTP cloud together, which is also known as Auto Ring Coupling.

Besides ring technology, the switch also supports 802.1D-2004 version Rapid Spanning Tree Protocol (RSTP). New version of RSTP standard includes 802.1D-1998 STP, 802.1w RSTP.

Following commands are included in this section:

- 4.5.1 RSTP**
- 4.5.2 RSTP Info**
- 4.5.3 MSTP Configuration**
- 4.5.4 MSTP Port Configuration**
- 4.5.5 MSTP Information**
- 4.5.6 Multiple Super Ring**
- 4.5.7 Ring Info**
- 4.5.8 Command Lines for Network Redundancy**

### 4.5.1 RSTP

RSTP is the abbreviation of Rapid Spanning Tree Protocol. If a switch has more than one path to a destination, it will lead to message loops that can generate broadcast storms and quickly bog down a network. The spanning tree was created to combat the negative effects of message loops in switched networks. A spanning tree uses a spanning tree algorithm (STA) to automatically sense whether a switch has more than one way to communicate with a node. It will then select the best path (primary), and block the other path(s). It will also keep track of the blocked path(s) in case the primary path fails. Spanning Tree Protocol

(STP) introduced a standard method to accomplish this. It is specified in IEEE 802.1D-1998. Later, Rapid Spanning Tree Protocol (RSTP) was adopted and represents the evolution of STP, providing much faster spanning tree convergence after a topology change. This is specified in IEEE 802.1w. In 2004, 802.1w is included into 802.1D-2004 version. This switch supports both RSTP and STP (all switches that support RSTP are also backward compatible with switches that support only STP).

This page allows you to enable/disable RSTP, configure the global setting and port settings.

**STP Configuration**

STP Mode: RSTP

**Bridge Configuration**

Bridge Address	0012.77ff.3310
Bridge Priority	32768
Max Age	20
Hello Time	2
Forward Delay	15

Apply

**RSTP Mode:** You must first enable STP/RSTP mode, before configuring any related parameters. Parameter settings required for both STP and RSTP are the same. Note that 802.1d refers to STP mode, while 802.1w refers to faster RSTP mode.

**Bridge Configuration**

**Priority (0-61440):** RSTP uses bridge ID to determine the root bridge, the bridge with the highest bridge ID becomes the root bridge. The bridge ID is composed of bridge priority and bridge MAC address. So that the bridge with the highest priority becomes the highest bridge ID. If all the bridge ID has the same priority, the bridge with the lowest MAC address will then become the root bridge.

Note: The bridge priority value must be in multiples of 4096. A device with a lower number has a higher bridge priority. Ex: 4096 is higher than 32768.

**Max Age (6-40):** Enter a value from 6 to 40 seconds here. This value represents the time that a bridge will wait without receiving Spanning Tree Protocol configuration messages before attempting to reconfigure.

If the switch is not the root bridge, and if it has not received a hello message from the root bridge in an amount of time equal to Max Age, then it will

reconfigure itself as a root bridge. Once two or more devices on the network are recognized as a root bridge, the devices will renegotiate to set up a new spanning tree topology.

**Hello Time (1-10):** Enter a value from 1 to 10 seconds here. This is a periodic timer that drives the switch to send out BPDU (Bridge Protocol Data Unit) packet to check current STP status.

The root bridge of the spanning tree topology periodically sends out a “hello” message to other devices on the network to check if the topology is “healthy”. The “hello time” is the amount of time the root has waited during sending hello messages.

**Forward Delay Time (4-30):** Enter a value between 4 and 30 seconds. This value is the time that a port waits before changing from Spanning Tree Protocol learning and listening states to forwarding state.

This is the amount of time the switch will wait before checking to see if it should be changed to a different state.

Once you have completed your configuration, click on **Apply** to apply your settings.

**Note:** You must observe the following rule to configure Hello Time, Forwarding Delay, and Max Age parameter

$$2 \times (\text{Forward Delay Time} - 1 \text{ sec}) \geq \text{Max Age Time} \geq 2 \times (\text{Hello Time value} + 1 \text{ sec})$$

### Port Configuration

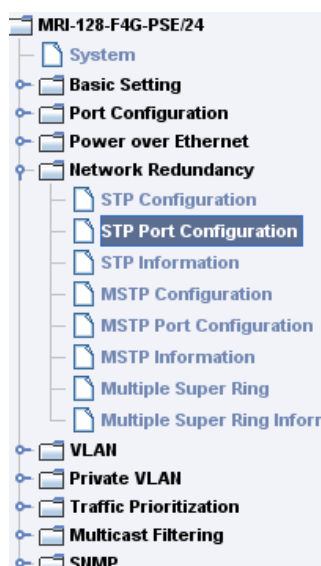

### STP Port Configuration

Port	STP State	Path Cost	Priority	Link Type	Edge Port
1	Enable	200000	128	Auto	Enable
2	Enable	200000	128	Auto	Enable
3	Enable	200000	128	Auto	Enable
4	Enable	200000	128	Auto	Enable
5	Enable	200000	128	Auto	Enable
6	Enable	200000	128	Auto	Enable
7	Enable	200000	128	Auto	Enable
8	Enable	200000	128	Auto	Enable
9	Enable	200000	128	Auto	Enable
10	Enable	200000	128	Auto	Enable

Apply

Select the port you want to configure and you will be able to view current settings and status of the port.

**Path Cost:** Enter a number between 1 and 200,000,000. This value represents the

“cost” of the path to the other bridge from the transmitting bridge at the specified port.

**Priority:** Enter a value between 0 and 240, using multiples of 16. This is the value that decides which port should be blocked by priority in a LAN.

**Admin P2P:** Some of the rapid state transitions that are possible within RSTP depend upon whether the port of concern can only be connected to another bridge (i.e. it is served by a point-to-point LAN segment), or if it can be connected to two or more bridges (i.e. it is served by a shared-medium LAN segment). This function allows P2P status of the link to be manipulated administratively. “**Auto**” means to auto select P2P or Share mode. “**P2P**” means P2P is enabled, while “**Share**” means P2P is disabled.

**Admin Edge:** A port directly connected to the end stations cannot create a bridging loop in the network. To configure this port as an edge port, set the port to the **Enable** state. When the non-bridge device connects an admin edge port, this port will be in blocking state and turn to forwarding state in 4 seconds.

Once you finish your configuration, click on **Apply** to save your settings.

#### 4.5.2 RSTP Info

### RSTP Information

#### Root Information

Bridge ID	8000.0007.7ce6.000c
Root Priority	32768
Root Port	N/A
Root Path Cost	0
Max Age(6-40)	20 sec
Hello Time(1-10)	2 sec
Forward Delay(4-30)	15 sec

#### Port Information

Port	Role	Port State	Oper Path Cost	Port Priority	Oper P2P	Oper Edge	Aggregated(ID/Typ...
1	--	Disabled	200000	128	P2P	Edge	--
2	--	Disabled	200000	128	P2P	Edge	--
3	--	Disabled	200000	128	P2P	Edge	--
4	--	Disabled	200000	128	P2P	Edge	--
5	--	Disabled	200000	128	P2P	Edge	--
6	--	Disabled	200000	128	P2P	Edge	--
7	Designated	Forwarding	200000	128	P2P	Edge	--
8	--	Disabled	20000	128	P2P	Edge	--
9	--	Disabled	20000	128	P2P	Edge	--
10	--	Disabled	20000	128	P2P	Edge	--

This page allows you to see the information of the root switch and port status.

**Root Information:** You can see root Bridge ID, Root Priority, Root Port, Root Path Cost and the Max Age, Hello Time and Forward Delay of BPDU sent from the root switch.

**Port Information:** You can see port Role, Port State, Path Cost, Port Priority, Oper P2P mode, Oper edge port mode and Aggregated (ID/Type).

### 4.5.3 MSTP Configuration

MSTP is the abbreviation of Multiple Spanning Tree Protocol. This protocol is a direct extension of RSTP. It can provide an independent spanning tree for different VLANs. It simplifies network management, provides for even faster convergence than RSTP by limiting the size of each region, and prevents VLAN members from being segmented from the rest of the group (as sometimes occurs with IEEE 802.1D STP).

While using MSTP, there are some new concepts of network architecture. A switch may belong to different groups, act as root or designate switch, generate BPDU for the network to maintain the forwarding table of the spanning tree. With MSTP can also provide multiple forwarding paths and enable load balancing. Understand the architecture allows you to maintain the correct spanning tree and operate effectively.

One VLAN can be mapped to a Multiple Spanning Tree Instance (MSTI). For example, the maximum Instance we support is usually 16, range from 0-15. The MSTP builds a separate Multiple Spanning Tree (MST) for each instance to maintain connectivity among each of the assigned VLAN groups. An Internal Spanning Tree (IST) is used to connect all the MSTP switches within an MST region. An MST Region may contain multiple MSTP Instances.

The figure shows there are 2 VLANs/MSTP Instances and each instance has its Root and forwarding paths.

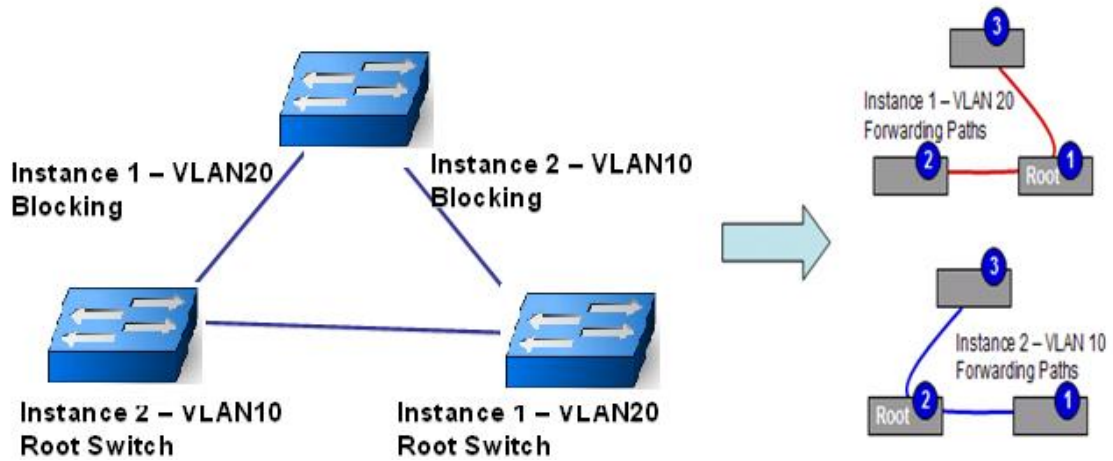

A Common Spanning Tree (CST) interconnects all adjacent MST regions and acts as a virtual bridge node for communications with STP or RSTP nodes in the global network. MSTP connects all bridges and LAN segments with a single Common and Internal Spanning Tree (CIST). The CIST is formed as a result of the running spanning tree algorithm between switches that support the STP, RSTP, MSTP protocols.

The figure shows the CST large network. In this network, a Region may have

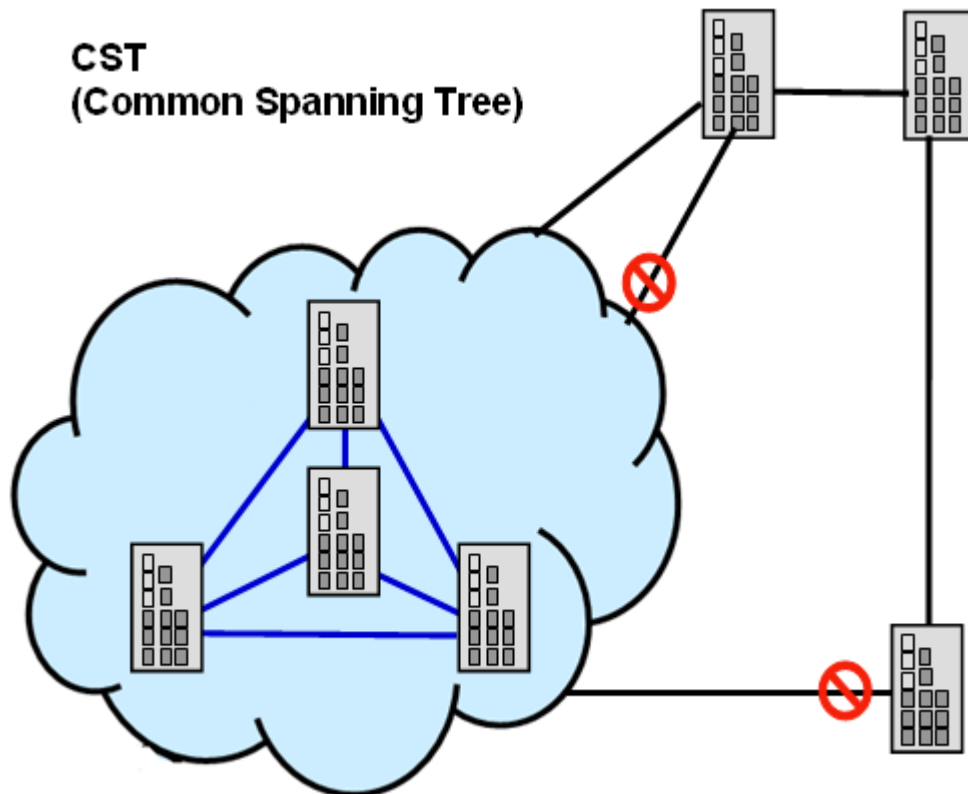

different instances and its own forwarding path and table, however, it acts as a single Bridge of CST.

To configure the MSTP setting, the STP Mode of the STP Configuration page should be changed to MSTP mode first.

## STP Configuration

STP Mode  ▼

### Bridge Configuration

Bridge Address	0007.7ce6.0000
Bridge Priority	32768 ▼
Max Age	20 ▼
Hello Time	2 ▼
Forward Delay	15 ▼

After enabled MSTP mode, then you can go to the MSTP Configuration pages.

### MSTP Region Configuration

This page allows configure the Region Name and its Revision, mapping the VLAN to Instance and check current MST Instance configuration. The network can be divided virtually to different Regions. The switches within the Region should have the same Region and Revision level.

**Region Name:** The name for the Region. Maximum length: 32 characters.

**Revision:** The revision for the Region. Range: 0-65535; Default: 0)

Once you finish your configuration, click on **Apply** to apply your settings.

### New MST Instance

This page allows mapping the VLAN to Instance and assign priority to the instance. Before mapping VLAN to Instance, you should create VLAN and assign the member ports first. Please refer to the VLAN setting page.

# MSTP Configuration

## MST Region Configuration

Region Name	Westermo
Revision	0

Apply

## New MST Instance

Instance ID	1
VLAN Group	
Instance Priority	32768

Add

**Instance ID:** Select the Instance ID, the available number is 1-15.

**VLAN Group:** Type the VLAN ID you want mapping to the instance.

**Instance Priority:** Assign the priority to the instance.

**After** finish your configuration, click on **Add** to apply your settings.

## Current MST Instance Configuration

This page allows you to see the current MST Instance Configuration you added. Click on **“Apply”** to apply the setting. You can **“Remove”** the instance or **“Reload”** the configuration display in this page.

## Current MST Instance Configuration

Instance ID	VLAN Group	Instance Priority
1	2	32768
2	3	32768

Modify Remove Reload

#### 4.5.4 MSTP Port Configuration

This page allows configure the Port settings. Choose the Instance ID you want to configure. The MSTP enabled and linked up ports within the instance will be listed in this table.

Note that the ports not belonged to the Instance, or the ports not MSTP activated will not display. The meaning of the Path Cost, Priority, Link Type and Edge Port is the same as the definition of RSTP.

### MSTP Port Configuration

Instance ID

Port	Path Cost	Priority	Link Type	Edge Port
1	200000	128	Auto	Enable
2	200000	128	Auto	Enable
3	200000	128	Auto	Enable
4	200000	128	Auto	Enable
5	200000	128	Auto	Enable
6	200000	128	Auto	Enable
7	200000	128	Auto	Enable
8	200000	128	Auto	Enable
9	200000	128	Auto	Enable
10	200000	128	Auto	Enable

**Path Cost:** Enter a number between 1 and 200,000,000. This value represents the “cost” of the path to the other bridge from the transmitting bridge at the specified port.

**Priority:** Enter a value between 0 and 240, using multiples of 16. This is the value that decides which port should be blocked by priority in a LAN.

**Link Type:** There are 3 types for you select. **Auto**, **P2P** and **Share**.

Some of the rapid state transitions that are possible within RSTP depend upon whether the port of concern can only be connected to another bridge (i.e. it is served by a point-to-point LAN segment), or if it can be connected to two or more bridges (i.e. it is served by a shared-medium LAN segment). This function allows link status of the link to be manipulated administratively. “**Auto**” means to auto select P2P or Share mode. “**P2P**” means P2P is enabled, the 2 ends work in Full duplex mode. While “**Share**” is enabled, it means P2P is disabled, the 2 ends may connect through a share media and work in Half duplex mode.

**Edge:** A port directly connected to the end stations cannot create a bridging loop in the network. To configure this port as an edge port, set the port to the **Enable** state. When the non-bridge device connects an admin edge port, this port will be in blocking state and turn to forwarding state in 4 seconds.

Once you finish your configuration, click on **Apply** to save your settings.

#### 4.5.5 MSTP Information

This page allows you to see the current MSTP information.

Choose the **Instance ID** first. If the instance is not added, the information remains blank.

The **Root Information** shows the setting of the Root switch.

The **Port Information** shows the port setting and status of the ports within the instance.

### MSTP Information

Instance ID  ▼

#### Root Information

<b>Root Address</b>	0007.7ce6.0000
<b>Root Priority</b>	32768
<b>Root Port</b>	N/A
<b>Root Path Cost</b>	0
<b>Max Age</b>	20 second(s)
<b>Hello Time</b>	2 second(s)
<b>Forward Delay</b>	15 second(s)

#### Port Information

Port	Role	Port State	Path Cost	Port Priority	Link Type	Edge Port
1	Designated	Forwarding	200000	128	P2P Bound(RSTP)	Non-Edge
2	—	Blocking	200000	128	P2P Internal(MSTP)	Edge
3	—	Blocking	200000	128	P2P Internal(MSTP)	Edge

Click on **“Reload”** to reload the MSTP information display.

#### 4.5.6 Multiple Super Ring (MSR)

The most common industrial network redundancy is to form a ring or loop. Typically, the managed switches are connected in series and the last switch is connected back to the first one.

The Multiple Super Ring has enhanced Ring Master selection and faster recovery

time. It is also enhanced for more complex ring application.

**Multiple Super Ring (MSR)** technology ranks the fastest restore and failover time in the world, 0 ms for restore and about milliseconds level for failover for 100Base-TX copper port. The other interface may take longer time due to the media characteristics.

Advanced **Rapid Dual Homing (RDH)** technology also facilitates Switch Managed Switch to connect with a core managed switch easily and conveniently. With RDH technology, you can also couple several Rapid Super Rings or RSTP cloud together, which is also known as Auto Ring Coupling.

**TrunkRing** technology allows integrate MSR with LACP/Port Trunking. The LACP/Trunk aggregated ports is a virtual interface and it can work as the Ring port of the MSR.

**MultiRing** is an outstanding technology that multiple rings can be aggregated within one switch by using different Ring ID. The maximum Ring number one switch can support is half of total port volume. For example, the switch is a 24+4G port design, which means 12 x 100M Rings and 2 Gigabit Rings can be aggregated to one the switch. The feature saves much effort when constructing complex network architecture.

This page allows you to enable the settings for Multiple Super Ring and Rapid Dual Homing.

**New Ring:** To create a Rapdis Super Ring. Jjust fill in the Ring ID which has range from 0 to 31. If the name field is left blank, this ring will be automatically named with Ring ID.

The screenshot shows the configuration page for 'MRI-128-F4G-PSE/24'. The left sidebar contains a tree view with categories like System, Basic Setting, Port Configuration, Power over Ethernet, Network Redundancy, VLAN, Private VLAN, Traffic Prioritization, Multicast Filtering, SHMP, Security, Warning, Monitor and Diag, Device Front Panel, and Save. The 'Multiple Super Ring' option under Network Redundancy is selected.

The main content area is titled 'Multiple Super Ring' and contains two sections:

- New Ring:** A form with two input fields: 'Ring ID' and 'Name'. Below the fields is an 'Add' button.
- Ring Configuration:** A table with the following columns: ID, Name, Version, Device Priority, Ring Port1, Path Cost, Ring Port2, Path Cost, Rapid Dual Homing, and Ring Status. The table is currently empty.

At the bottom of the configuration area are three buttons: 'Apply', 'Remove', and 'Reload'.

### Ring Configuration

**ID:** Once a Ring is created, it appears and can not be changed. In multiple rings'

environment, the traffic can only be forwarded under the same ring ID.

**Name:** This field will show the name of the Ring. If it is not filled in when creating, it will be automatically named by the rule “RingID”.

**Version:** The version of Ring can be changed here. There are three modes to choose: Rapid Super Ring as default.

**Device Priority:** The switch with highest priority (highest value) will be automatically selected as Ring Master. Then one of the ring ports in this switch will become forwarding port and the other one will become blocking port. If all of the switches have the same priority, the switch with the biggest MAC address will be selected as Ring Master.

**Ring Port1:** In Rapid Super Ring environment, you should have 2 Ring Ports. No matter this switch is Ring Master or not, when configuring RSR, 2 ports should be selected to be Ring Ports. For Ring Master, one of the ring ports will become the forwarding port and the other one will become the blocking port.

**Path Cost:** Change the Path Cost of Ring Port1. If this switch is the Ring Master of a Ring, then it determines the blocking port. The Port with higher Path Cost in the two ring Port will become the blocking port, If the Path Cost is the same, the port with larger port number will become the blocking port.

**Ring Port2:** Assign another port for ring connection

**Path Cost:** Change the Path Cost of Ring Port2

**Rapid Dual Homing:** Rapid Dual Homing is a feature of MSR. When you want to connect multiple RSR or form a redundant topology with other vendors, RDH could allow you to have maximum seven multiple links for redundancy without any problem.

In Rapid Dual Homing, you don't need to configure specific port to connect to other protocol. The Rapid Dual Homing will smartly choose the fastest link for primary link and block all the other links to avoid loop. If the primary link failed, Rapid Dual Homing will automatically forward the secondary link for network redundancy. If there are more connections, they will be standby links and recover one of them if both primary and secondary links are down.

**Ring status:** To enable/disable the Ring. Please remember to enable the ring after you add it.

#### 4.5.7 Ring Info

This page shows the RSR information.

## Multiple Super Ring Information

ID	Version	Role	Status	RM MAC	Blocking Port	Role Transition Count	Ring State Transition Count
1	Rapid Super Ring	RM	Normal	0007.7ce6.000c	Port10	2	4

Reload

**ID:** Ring ID.

**Version:** which version of this ring.

**Role:** This Switch is RM or nonRM

**Status:** If this field is Normal which means the redundancy is activated. If any one of the links in the Ring is down, then the status will be Abnormal.

**RM MAC:** The MAC address of Ring Master of this Ring. It helps to find the redundant path.

**Blocking Port:** This field shows which is blocked port of RM.

**Role Transition Count:** This shows how many times this switch has changed its Role from nonRM to RM or from RM to nonRM.

**Role state Transition Count:** This number shows how many times the Ring status has been transformed between Normal and Abnormal state.

### 4.5.8 Command Lines:

Feature	Command Line
<b>Global</b>	
Enable	Switch(config)# spanning-tree enable
Disable	Switch (config)# spanning-tree disable
Mode (Choose the Spanning Tree mode)	Switch(config)# spanning-tree mode rst the rapid spanning-tree protocol (802.1w) stp the spanning-tree prtocol (802.1d) mst the multiple spanning-tree protocol (802.1s)
Bridge Priority	Switch(config)# spanning-tree priority <0-61440> valid range is 0 to 61440 in multiple of 4096 Switch(config)# spanning-tree priority 4096
Bridge Times	Switch(config)# spanning-tree bridge-times (forward Delay)

	<p>(max-age) (Hello Time)</p> <p>Switch(config)# spanning-tree bridge-times 15 20 2</p> <p>This command allows you configure all the timing in one time.</p>
Forward Delay	<p>Switch(config)# spanning-tree forward-time</p> <p>&lt;4-30&gt; Valid range is 4~30 seconds</p> <p>Switch(config)# spanning-tree forward-time 15</p>
Max Age	<p>Switch(config)# spanning-tree max-age</p> <p>&lt;6-40&gt; Valid range is 6~40 seconds</p> <p>Switch(config)# spanning-tree max-age 20</p>
Hello Time	<p>Switch(config)# spanning-tree hello-time</p> <p>&lt;1-10&gt; Valid range is 1~10 seconds</p> <p>Switch(config)# spanning-tree hello-time 2</p>
<b>MSTP</b>	
Enter the MSTP Configuration Tree	<p>Switch(config)# spanning-tree mst</p> <p>MSTMAP            the mst instance number or range</p> <p>configuration    enter mst configuration mode</p> <p>forward-time    the forwaoreneya time</p> <p>hello-time       the hello time</p> <p>max-age           the message maximum age time</p> <p>max-hops         the maximum hops</p> <p>sync              sync port state of exist vlan entry</p> <p>Switch(config)# spanning-tree mst configuration</p> <p>Switch(config)# spanning-tree mst configuration</p> <p>Switch(config-mst)#</p> <p>abort            exit current mode and discard all changes</p> <p>end               exit current mode, change to enable mode and apply all changes</p> <p>exit              exit current mode and apply all changes</p> <p>instance        the mst instance</p> <p>list             Print command list</p> <p>name             the name of mst region</p> <p>no               Negate a command or set its defaults</p> <p>quit             exit current mode and apply all changes</p> <p>revision        the revision of mst region</p> <p>show             show mst configuration</p>
Region	Region Name:

Configuration	<pre>Switch(config-mst)# name     NAME the name string Switch(config-mst)# naorenixnix Region Revision: Switch(config-mst)# revision     &lt;0-65535&gt; the value of revision Switch(config-mst)# revision 65535</pre>
Mapping Instance to VLAN (Ex: Mapping VLAN 2 to Instance 1)	<pre>Switch(config-mst)# instance     &lt;1-15&gt; target instance number Switch(config-mst)# instance 1 vlan     VLANMAP target vlan number(ex.10) or range(ex.1-10) Switch(config-mst)# instance 1 vlan 2</pre>
Display Current MST Configuration	<pre>Switch(config-mst)# show current Current MST configuration Name    orenixnix] Revision 65535 Instance Vlans Mapped ----- 0        1,4-4094 1        2 2        -- Config HMAC-MD5 Digest: 0xB41829F9030A054FB74EF7A8587FF58D -----</pre>
Remove Region Name	<pre>Switch(config-mst)# no name name configure revision revision configure instance the mst instance Switch(config-mst)# no name</pre>
Remove Instance example	<pre>Switch(config-mst)# no instance     &lt;1-15&gt; target instance number Switch(config-mst)# no instance 2</pre>
Show Pending MST Configuration	<pre>Switch(config-mst)# show pending Pending MST configuration Name    [] (-&gt;The name is removed by no name) Revision 65535 Instance Vlans Mapped ----- 0        1,3-4094 1        2 (-&gt;Instance 2 is removed by no instance -- Config HMAC-MD5 Digest:</pre>

	0x3AB68794D602FDF43B21C0B37AC3BCA8 -----
Apply the setting and go to the configuration mode	Switch(config-mst)# quit apply all mst configuration changes Switch(config)#
Apply the setting and go to the global mode	Switch(config-mst)# end apply all mst configuration changes Switch#
Abort the Setting and go to the configuration mode.  Show Pending to see the new settings are not applied.	Switch(config-mst)# abort discard all mst configuration changes Switch(config)# spanning-tree mst configuration Switch(config-mst)# show pending Pending MST configuration Name     orenixnix] (->The name is not applied after Abort settings.) Revision   65535 Instance   Vlans Mapped  ----- 0           1,4-4094 1           2 2           3   (-> The instance is not applied after Abort settings-- Config HMAC-MD5 Digest: 0xB41829F9030A054FB74EF7A8587FF58D -----
<b>RSTP</b>	
The mode should be rst, the timings can be configured in global settings listed in above.	
<b>Global Information</b>	
Active Information	Switch# show spanning-tree active  Spanning-Tree :   Enabled                    Protocol :   MSTP Root Address :   0012.77ee.eeee   Priority :   32768 Root Path Cost :   0                                Root Port :   N/A Root Times :   max-age 20, hello-time 2, forward-delay 15 Bridge Address : 0012.77ee.eeee   Priority :   32768 Bridge Times : max-age 20, hello-time 2, forward-delay 15 BPDU transmission-limit : 3  Port        Role        State    Cost    Prio.Nbr   Type Aggregated  ----- fa1   Designated Forwarding   200000   128.1 P2P(RSTP)   N/A

	<pre> fa2 Designated Forwarding 200000 128.2 P2P(RSTP) N/A </pre>
RSTP Summary	<pre> Switch# show spanning-tree summary Switch is in rapid-stp mode. BPDU skewing detection disabled for the bridge. Backbonefast disabled for bridge. Summary of connected spanning tree ports : #Port-State Summary Blocking  Listening  Learning  Forwarding  Disabled -----  - 0         0         0         0         2 26 #Port Link-Type Summary AutoDetected  PointToPoint  SharedLink  EdgePort ----- 9             0             1 9 </pre>
Port Info	<pre> Switch# show spanning-tree port detail fa7 (Interface_ID) Rapid Spanning-Tree feature Enabled Port 128.6 as Disabled Role is in Disabled State Port Path Cost 200000, Port Identifier 128.6 RSTP Port Admin Link-Type is Auto, Oper Link-Type is Point-to-Point RSTP Port Admin Edge-Port is Enabled, Oper Edge-Port is Edge Designated root has priority 32768, address 0007.7c00.0112 Designated bridge has priority 32768, address 0007.7c60.1aec Designated Port ID is 128.6, Root Path Cost is 600000 Timers : message-age 0 sec, forward-delay 0 sec  Link Aggregation Group: N/A, Type: N/A, Aggregated with: N/A  BPDU: sent 43759 , received 4854 TCN : sent 0 , received 0 Forwarding-State Transmit count 12 Message-Age Expired count </pre>

**MSTP Information-**

```

MSTP Configuration- Switch# show spanning-tree mst configuration
Current MST configuration (MSTP is Running)
Name      orenixnix]
Revision  65535
Instance  Vlans Mapped
-----
0         1,4-4094
1         2
2         --
Config HMAC-MD5 Digest:
0xB41829F9030A054FB74EF7A8587FF58D
-----
    
```

```

Display all MST Information Switch# show spanning-tree mst
##### MST00 vlans mapped: 1,4-4094
Bridge address 0012.77ee.eeee priority 32768
(sysid 0)
Root this switch for CST and IST
Configured max-age 2, hello-time 15, forward-delay
20, max-hops 20

Port Role State Cost Prio.Nbr
Type
-----
fa1 Designated Forwarding 200000 128.1 P2P
Internal(MSTP)
fa2 Designated Forwarding 200000 128.2 P2P
Internal(MSTP)

##### MST01 vlans mapped: 2
Bridge address 0012.77ee.eeee priority 32768
(sysid 1)
Root this switch for MST01

Port Role State Cost Prio.Nbr
Type
-----
fa1 Designated Forwarding 200000 128.1 P2P
    
```

	<pre> Internal(MSTP)   fa2 Designated Forwarding 200000 128.2 P2P Internal(MSTP) </pre>
MSTP Root Information	<pre> Switch# show spanning-tree mst root   MST      Root      Root      Root      Root      Max Hello Fwd Instance  Address      Priority   Cost      Port      age dly -----   MST00  0012.77ee.eeee  32768    0         N/A      20 2  15   MST01  0012.77ee.eeee  32768    0         N/A      20 2  15   MST02  0012.77ee.eeee  32768    0         N/A      20 2  15 </pre>
MSTP Instance Information	<pre> Switch# show spanning-tree mst 1 ##### MST01 vlans mapped: 2 Bridge address 0012.77ee.eeee priority 32768 (sysid 1) Root this switch for MST01  Port      Role      State      Cost      Prio.Nbr Type -----   fa1  Designated Forwarding 200000 128.1 P2P Internal(MSTP)   fa2  Designated Forwarding 200000 128.2 P2P Internal(MSTP) </pre>
MSTP Port Information	<pre> Switch# show spanning-tree mst interface fa1 Interface fastethernet1 of MST00 is Designated Forwarding Edge Port : Edge (Edge)          BPDU Filter : Disabled Link Type : Auto (Point-to-point) BPDU Guard : Disabled Boundary : Internal(MSTP) BPDUs : sent 6352, received 0  Instance  Role      State      Cost      Prio.Nbr Vlans mapped ----- </pre>

	<pre> 0    Designated Forwarding    200000    128.1 1,4-4094 1    Designated Forwarding    200000    128.1 2 2    Designated Forwarding    200000    128.1 3 </pre>
<b>Multiple Super Ring</b>	
Create or configure a Ring	<pre> Switch(config)# multiple-super-ring 1 Ring 1 created Switch(config-multiple-super-ring)# </pre> <p><b>Note: 1 is the target Ring ID which is going to be created or configured.</b></p>
Super Ring Version	<pre> Switch(config-multiple-super-ring)# version default          set default to rapid super ring rapid-super-ring rapid super ring super-ring       super ring </pre> <pre> Switch(config-multiple-super-ring)# version rapid-super-ring </pre>
Priority	<pre> Switch(config-multiple-super-ring)# priority &lt;0-255&gt;  valid range is 0 to 255 default  set default </pre> <pre> Switch(config)# super-ring priority 100 </pre>
Ring Port	<pre> Switch(config-multiple-super-ring)# port IFLIST  Interface list, ex: fa1,fa3-5,gi25-28 cost    path cost </pre> <pre> Switch(config-multiple-super-ring)# port fa1,fa2 </pre>
Ring Port Cost	<pre> Switch(config-multiple-super-ring)# port cost &lt;0-255&gt;  valid range is 0 or 255 default  set default (128)valid range is 0 or 255 </pre> <pre> Switch(config-multiple-super-ring)# port cost 100 &lt;0-255&gt;  valid range is 0 or 255 default  set default (128)valid range is 0 or 255 </pre> <pre> Switch(config-super-ring-plus)# port cost 100 200 Set path cost success. </pre>
Rapid Dual Homing	<pre> Switch(config-multiple-super-ring)# rapid-dual-homing enable </pre> <pre> Switch(config-multiple-super-ring)# rapid-dual-homing disable </pre>

	<pre>Switch(config-multiple-super-ring)# rapid-dual-homing port   IFLIST      Interface name, ex: fastethernet1 or gi25   auto-detect up link auto detection   IFNAME      Interface name, ex: fastethernet1 or gi25 Switch(config-multiple-super-ring)# rapid-dual-homing port fa3,fa5-6 set Rapid Dual Homing port success. Note: auto-detect is recommended for dual Homing..</pre>
<b>Ring Info</b>	
Ring Info	<pre>Switch# show multiple-super-ring [Ring ID] [Ring1] Ring1 Current Status : Disabled   Role          : Disabled   Ring Status   : Abnormal   Ring Manager  : 0000.0000.0000   Blocking Port : N/A   Giga Copper   : N/A Configuration :   Version       : Rapid Super Ring   Priority      : 128   Ring Port     : fa1, fa2   Path Cost    : 100, 200 Dual-Homing II : Disabled Statistics :   Watchdog sent      0, received      0, missed 0   Link Up sent       0, received      0   Link Down sent    0, received      0   Role Transition count 0   Ring State Transition count 1  Ring ID is optional. If the ring ID is typed, this command will only display the information of the target Ring.</pre>

## 4.6 VLAN

A Virtual LAN (VLAN) is a “logical” grouping of nodes for the purpose of limiting a broadcast domain to specific members of a group without physically grouping the members together. That means, VLAN allows you to isolate network traffic so that only members of VLAN could receive traffic from the same VLAN members. Basically, creating a VLAN from a switch is the logical equivalent of physically reconnecting a group of network devices to another Layer 2 switch, without actually disconnecting these devices from their original switches.

The switch supports 802.1Q VLAN. 802.1Q VLAN is also known as Tag-Based VLAN. This Tag-Based VLAN allows VLAN to be created across different switches. IEEE 802.1Q tag-based VLAN makes use of VLAN control information stored in a VLAN header attached to IEEE 802.3 packet frames. This tag contains a VLAN Identifier (VID) that indicates which VLAN a frame belongs to. Since each switch only has to check a frame’s tag, without the need to dissect the contents of the frame, which also saves a lot of computing resources within the switch.

### QinQ

The QinQ is originally designed to expand the number of VLANs by adding a tag to the 802.1Q packets. The original VLAN is usually identified as Customer VLAN (C-VLAN) and the new

added tag - as Service VLAN(S-VLAN). By adding the additional tag, QinQ increases the possible number of VLANs. After QinQ enabled, the switch can reach up to 256x256 VLANs. With different standard tags, it also improves the network security.

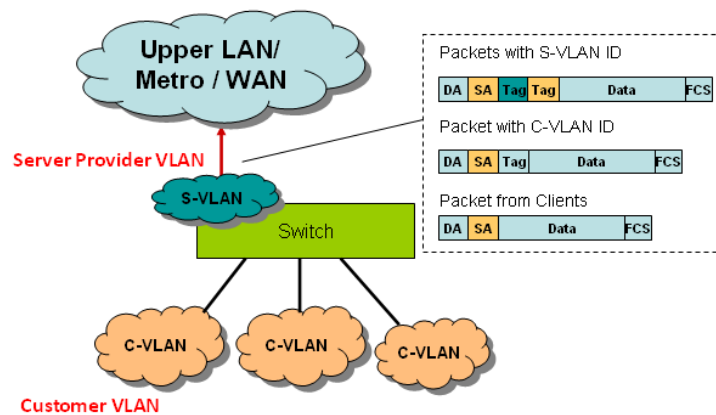

VLAN Configuration group enables you to Add/Remove VLAN, configure QinQ, port Ingress/Egress parameters and view VLAN table.

Following commands are included in this section:

- 4.6.1 VLAN Port Configuration
- 4.6.2 VLAN Configuration
- 4.6.3 GVRP Configuration
- 4.6.4 VLAN Table
- 4.6.5 CLI Commands of the VLAN

#### 4.6.1 VLAN Port Configuration

VLAN Port Configuration allows you to set up VLAN port parameters to specific port. These parameters include PVID, Accept Frame Type and Ingress Filtering.

**VLAN Port Configuration**

**VLAN Port Configuration**

Port	PVID	Tunnel Mode	EtherType	Accept Frame Type	Ingress Filtering
1	1	None	0x8100	Admit All	Disable
2	1	None	0x8100	Admit All	Disable
3	1	None	0x8100	Admit All	Disable
4	1	None	0x8100	Admit All	Disable
5	1	None	0x8100	Admit All	Disable
6	1	None	0x8100	Admit All	Disable
7	1	None	0x8100	Admit All	Disable
8	1	None	0x8100	Admit All	Disable
9	1	None	0x8100	Admit All	Disable
10	1	None	0x8100	Admit All	Disable

**PVID:** The abbreviation of the **Port VLAN ID**. Enter the port VLAN ID. PVID allows the switches to identify which port belongs to which VLAN. To keep things simple, it is recommended that PVID is equivalent to VLAN IDs.

The values of PVIDs are from 0 to 4095. But, 0 and 4095 are reserved. You can't input these two PVIDs and 1 is the default value and 2 to 4094 are valid and available. **Accept Frame Type:** This column defines the accepted frame type of the port. There are 2 modes you can select, **Admit All** and **Tag Only**. Admit All mode means that the port can accept both tagged and untagged packets. Tag Only mode means that the port can only accept tagged packets.

**Ingress Filtering:** Ingress filtering helps VLAN engine to filter out undesired traffic on a port. When Ingress Filtering is enabled, the port checks whether the incoming frames belong to the VLAN they claimed or not. Then the port determines if the frames can be processed or not. For example, if a tagged frame from Engineer VLAN is received, and Ingress Filtering is enabled, the switch will determine if the port is on the Engineer VLAN's Egress list. If it is, the frame can be processed. If it's not, the frame would be dropped.

**Tunnel Mode:** This is the new command for QinQ. The command includes None, 802.1Q Tunnel and 802.1Q Tunnel Uplink. The figure shows the relationship between 802.1Q Tunnel and 802.1Q Tunnel Uplink.

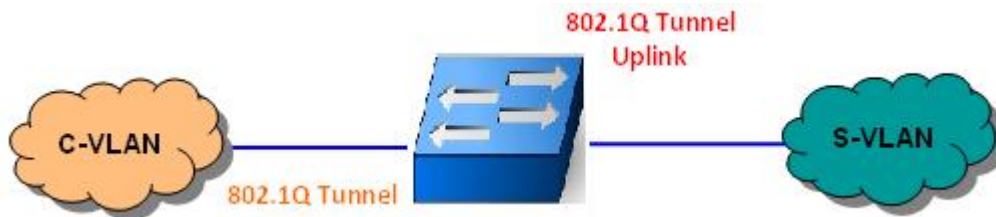

Following is the modes you can select.

**None:** Remian VLAN setting, no QinQ.

**802.1Q Tunnel:** The QinQ command applied to the ports which connect to the C-VLAN. The port receives tagged frame from the C-VLAN. Add a new tag (Port VID) as S-VLAN VID. When the packets are forwarded to C-VLAN, the S-VLAN tag is removed.

After 802.1Q Tunnel mode is assigned to a port, the egress setting of the port should be “**Untag**”, it indicates the egress packet is always untagged. This is configured in Static VLAN Configuration table. Please refer to the VLAN Configuration chapter in below.

**802.1Q Tunnel Uplink:** The QinQ command applied to the ports which connect to the S-VLAN. The port receives tagged frame from the S-VLAN. When the packets are forwarded to S-VLAN, the S-VLAN tag is kept.

After 802.1Q Tunnel Uplink mode is assigned to a port, the egress setting of the port should be “**Tag**”, it indicates the egress packet is always tagged. This is configured in Static VLAN Configuration table. Please refer to the VLAN Configuration chapter in below.

For example, the VID of S-VLAN/Tunnel Uplink is 10, the VID of C-VLAN/Tunnel is 5. The 802.1Q Tunnel port receives tag 5 from C-VLAN, add tag 10 to the packet. When the packets are forwarded to S-VLAN, tag 10 is kept.

**EtherType:** This column allows you to define the EtherType manually. This is advanced QinQ parameter which allows to define the transmission packet type.

#### 4.6.2 VLAN Configuration

In this page, you can assign Management VLAN, create the static VLAN, and assign the Egress rule for the member ports of the VLAN.

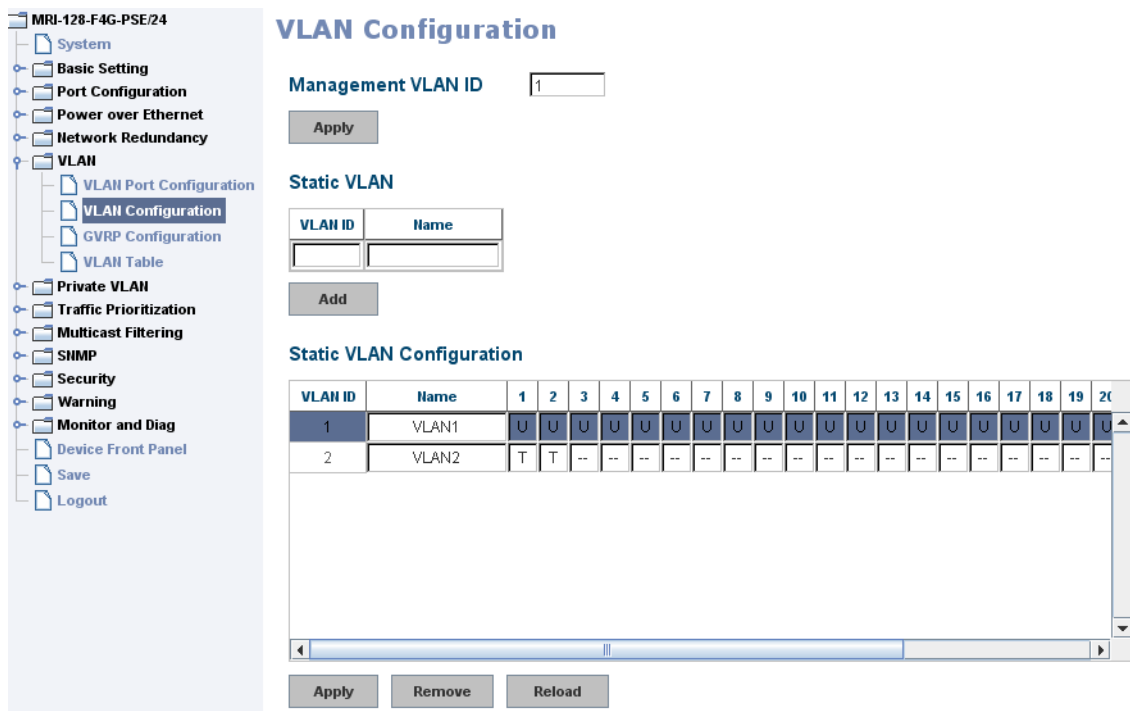

**Management VLAN ID:** The switch supports management VLAN. The management VLAN ID is the VLAN ID of the CPU interface so that only member ports of the management VLAN can access the switch. The default management VLAN ID is 1.

**Static VLAN:** You can assign a VLAN ID and VLAN Name for new VLAN here.

**VLAN ID** is used by the switch to identify different VLANs. Valid VLAN ID is between 1 and 4094 and VLAN 1 is the default VLAN.

**VLAN Name** is a reference for network administrator to identify different VLANs. The available character is 12 for you to input. If you don't input VLAN name, the system will automatically assign VLAN name for the VLAN. The rule is VLAN (VLAN ID).

The steps to create a new VLAN: Type VLAN ID and NAME, and press **Add** to create a new VLAN. Then you can see the new VLAN in the Static VLAN Configuration table.

After created the VLAN, the status of the VLAN will remain in Unused until you add ports to the VLAN.

**Note:** Before you change the management VLAN ID by Web and Telnet, remember that the port attached by the administrator should be the member port of the management VLAN; otherwise the administrator can't access the switch via the network.

**Note:** Currently The switch only support max 256 group VLAN.

### Static VLAN Configuration

You can see the created VLANs and specify the egress (outgoing) port rule to be **Untagged or Tagged**.

Static VLAN Configuration table. You can see that new VLAN 3 is created. VLAN name is test. Egress rules of the ports are not configured now.

#### Static VLAN Configuration

VLAN ID	Name	1	2	3	4	5	6	7	8	9	10	11	12	13	14	15	16	17	18
1	VLAN1	U	U	U	U	U	U	U	U	U	U	U	U	U	U	U	U	U	U
2	VLAN2	--	--	--	--	T	T	T	T	--	--	--	--	--	--	--	--	--	--
3	test	U	U	U	U	--	--	--	--	--	--	--	--	--	--	--	--	--	--

-- : Not available

**U : Untag:** Indicates that egress/outgoing frames are not VLAN tagged.

**T : Tag:** Indicates that egress/outgoing frames are to be VLAN tagged.

Steps to configure Egress rules: Select the VLAN ID. Entry of the selected VLAN turns to light blue. Assign Egress rule of the ports to **U** or **T**. Press **Apply** to apply the setting. If you want to remove one VLAN, select the VLAN entry. Then press **Remove** button.

### 4.6.3 GVRP configuration

GVRP allows users to set-up VLANs automatically rather than manual configuration on every port of every switch in the network.

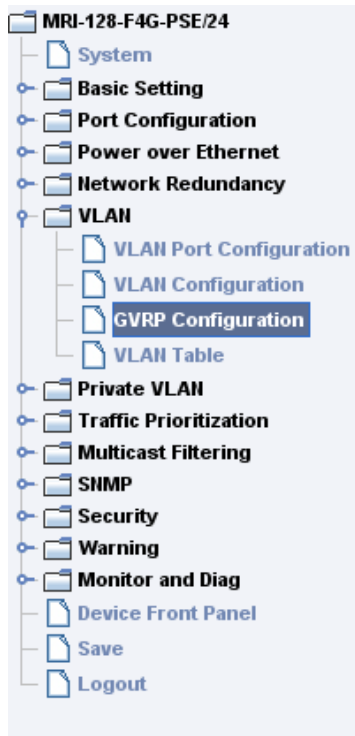

## GVRP Configuration

GVRP Protocol

Port	State	Join Timer	Leave Timer	Leave All Timer
1	Disable	20	60	1000
2	Disable	20	60	1000
3	Disable	20	60	1000
4	Disable	20	60	1000
5	Disable	20	60	1000
6	Disable	20	60	1000
7	Disable	20	60	1000
8	Disable	20	60	1000
9	Disable	20	60	1000
10	Disable	20	60	1000

Note: Timer unit is centiseconds.

**GVRP Protocol:** Allow user to enable/disable GVRP globally.

**State:** After enable GVRP globally, here still can enable/disable GVRP by port.

**Join Timer:** Controls the interval of sending the GVRP Join BPDU. An instance of this timer is required on a per-Port, per-GARP Participant basis.

**Leave Timer:** Control the time to release the GVRP reservation after received the GVRP Leave BPDU. An instance of the timer is required for each state machine that is in the LV state.

**Leave All Timer:** Controls the period to initiate the garbage collection of registered VLAN. The timer is required on a per-Port, per-GARP Participant basis.

### 4.6.4 VLAN Table

This table shows you current settings of your VLAN table, including VLAN ID, Name, Status, and Egress rule of the ports.

## VLAN Table

### VLAN Table

VLAN ID	Name	Status	1	2	3	4	5	6	7	8	9	10
1	VLAN1	Static	U	U	U	U	U	U	U	U	U	U

Reload

**VLAN ID:** ID of the VLAN.

**Name:** Name of the VLAN.

**Status:** **Static** shows this is a manually configured static VLAN. **Unused** means this VLAN is created by UI/CLI and has no member ports. This VLAN is not workable yet. **Dynamic** means this VLAN is learnt by GVRP.

After created the VLAN, the status of this VLAN will remain in Unused status until you add ports to the VLAN.

#### 4.6.5 CLI Commands of the VLAN

Command Lines of the VLAN port configuration, VLAN configuration and VLAN table display

Feature	Command Line
<b>VLAN Port Configuration</b>	
Port Interface Configuration	Switch# conf ter Switch(config)# interface fa5 Switch(config-if)#
VLAN Port PVID	Switch(config-if)# switchport trunk native vlan 2 Set port default vlan id to 2 success
<b>QinQ Tunnel Mode</b>	Switch(config-if)# switchport dot1q-tunnel mode Set the interface as an IEEE 802.1Q tunnel mode Switch(config-if)# switchport dot1q-tunnel mode

802.1Q Tunnel = access	access Set the interface as an access port of IEEE 802.1Q tunnel mode
802.1Q Tunnel Uplink = uplink	uplink Set the interface as an uplink port of IEEE 802.1Q tunnel mode
Port Accept Frame Type	Switch(config)# inter fa1 Switch(config-if)# acceptable frame type all any kind of frame type is accepted! Switch(config-if)# acceptable frame type vlan tagged only only vlan-tag frame is accepted!
Ingress Filtering (for fast Ethernet port 1)	Switch(config)# interface fa1 Switch(config-if)# ingress filtering enable ingress filtering enable Switch(config-if)# ingress filtering disable ingress filtering disable
Egress rule – Untagged (for VLAN 2)	Switch(config-if)# switchport access vlan 2 switchport access vlan - success
Egress rule – Tagged (for VLAN 2)	Switch(config-if)# switchport trunk allowed vlan add 2
Display – Port Ingress Rule (PVID, Ingress Filtering, Acceptable Frame Type)	Switch# show interface fa1 Interface fastethernet1 Administrative Status : Enable Operating Status : Not Connected Duplex : Auto Speed : Auto Flow Control : off Default Port VLAN ID: 2 Ingress Filtering : Disabled Acceptable Frame Type : All Port Security : Disabled Auto Negotiation : Enable Loopback Mode : None STP Status: disabled Default CoS Value for untagged packets is 0. Mdix mode is Auto. Medium mode is Copper.

<p>Display – Port Egress Rule (Egress rule, IP address, status)</p>	<pre>Switch# show running-config ..... ! interface fastethernet1   switchport access vlan 1   switchport access vlan 3   switchport trunk native vlan 2 ..... interface vlan1   ip address 192.168.2.8/24   no shutdown</pre>
<p>QinQ Information – 802.1Q Tunnel</p>	<pre>Switch# show dot1q-tunnel dot1q-tunnel mode por 1 : normal por 2 : normal por 3 : normal por 4 : normal por 5 : access por 6 : uplink por 7 : normal por 8 : normal por 9 : normal port 10 : normal-</pre>
<p>QinQ Information – Show Running</p>	<pre>Switch# show running-config Building configuration...  Current configuration: hostname Switch vlan learning independent ..... ..... interface fastethernet5   switchport access vlan add 1-2,10   switchport dot1q-tunnel mode access ! interface fastethernet6</pre>

	<pre>switchport access vlan add 1-2 switchport trunk allowed vlan add 10 switchport dot1q-tunnel mode uplink !</pre>
<b>VLAN Configuration</b>	
Create VLAN (2)	<pre>Switch(config)# vlan 2 vlan 2 success  Switch(config)# interface vlan 2 Switch(config-if)#</pre> <p><i>Note: In CLI configuration, you should create a VLAN interface first. Then you can start to add/remove ports. Default status of the created VLAN is unused until you add member ports to it.</i></p>
Remove VLAN	<pre>Switch(config)# no vlan 2 no vlan success</pre> <p><i>Note: You can only remove the VLAN when the VLAN is in unused mode.</i></p>
VLAN Name	<pre>Switch(config)# vlan 2 vlan 2 has exists Switch(config-vlan)# name v2  Switch(config-vlan)# no name</pre> <p><i>Note: Use no name to change the name to default name, VLAN VID.</i></p>
VLAN description	<pre>Switch(config)# interface vlan 2 Switch(config-if)# Switch(config-if)# description this is the VLAN 2  Switch(config-if)# no description -&gt;Delete the description.</pre>
IP address of the VLAN	<pre>Switch(config)# interface vlan 2 Switch(config-if)# Switch(config-if)# ip address 192.168.2.200/24</pre>

	Switch(config-if)# no ip address 192.168.2.200/24 ->Delete the IP address
Create multiple VLANs (VLAN 5-10)	Switch(config)# interface vlan 5-10
Shut down VLAN	Switch(config)# interface vlan 2 Switch(config-if)# shutdown  Switch(config-if)# no shutdown ->Turn on the VLAN
Display – VLAN table	Switch# sh vlan <pre> VLAN Name    Status    Trunk Ports    Access Ports ----- 1     VLAN1    Static        -             fa1-7,gi25-27 2     VLAN2    Unused        -             - 3     test     Static        fa4-7,gi25-27 fa1-3,fa7,gi25-27 </pre>
Display – VLAN interface information	Switch# show interface vlan1 <pre> interface vlan1 is up, line protocol detection is disabled index 14 metric 1 mtu 1500 &lt;UP,BROADCAST,RUNNING,MULTICAST&gt; HWaddr: 00:07:7c:ff:01:b0 inet 192.168.2.200/24 broadcast 192.168.2.255 input packets 639, bytes 38248, dropped 0, multicast packets 0 input errors 0, length 0, overrun 0, CRC 0, frame 0, fifo 0, missed 0 output packets 959, bytes 829280, dropped 0 output errors 0, aborted 0, carrier 0, fifo 0, heartbeat 0, window 0 collisions 0 </pre>
<b>GVRP configuration</b>	
GVRP enable/disable	Switch(config)# gvrp mode <pre> disable  Disable GVRP feature globally on the switch enable   Enable GVRP feature globally on the switch Switch(config)# gvrp mode enable Gvrp is enabled on the switch! </pre>
Configure GVRP	Switch(config)# inter fa1

timer	Switch(config-if)# garp timer <10-10000>
Join timer /Leave timer/ LeaveAll timer	Switch(config-if)# garp timer 20 60 1000 Note: The unit of these timer is centisecond
<b>Management VLAN</b>	
Management VLAN	Switch(config)# int vlan 1 (Go to management VLAN) Switch(config-if)# no shutdown
Display	Switch# show running-config ..... ! interface vlan1 ip address 192.168.2.200/24 ip igmp no shutdown ! .....

## 4.7 Private VLAN

The private VLAN helps to resolve the primary VLAN ID shortage, client ports' isolation and network security issues. The Private VLAN provides primary and secondary VLAN within a single switch.

**Primary VLAN:** The uplink port is usually the primary VLAN. A primary VLAN contains promiscuous ports that can communicate with lower Secondary VLANs.

**Secondary VLAN:** The client ports are usually defined within secondary VLAN. The secondary VLAN includes Isolated VLAN and Community VLAN. The client ports can be isolated VLANs or can be grouped in the same Community VLAN. The ports within the same community VLAN can communicate with each other. However, the isolated VLAN ports can Not.

The figure shows the typical Private VLAN network. The SCADA/Public Server or NMS workstation is usually located in primary VLAN. The clients PCs or Rings are located within Secondary.

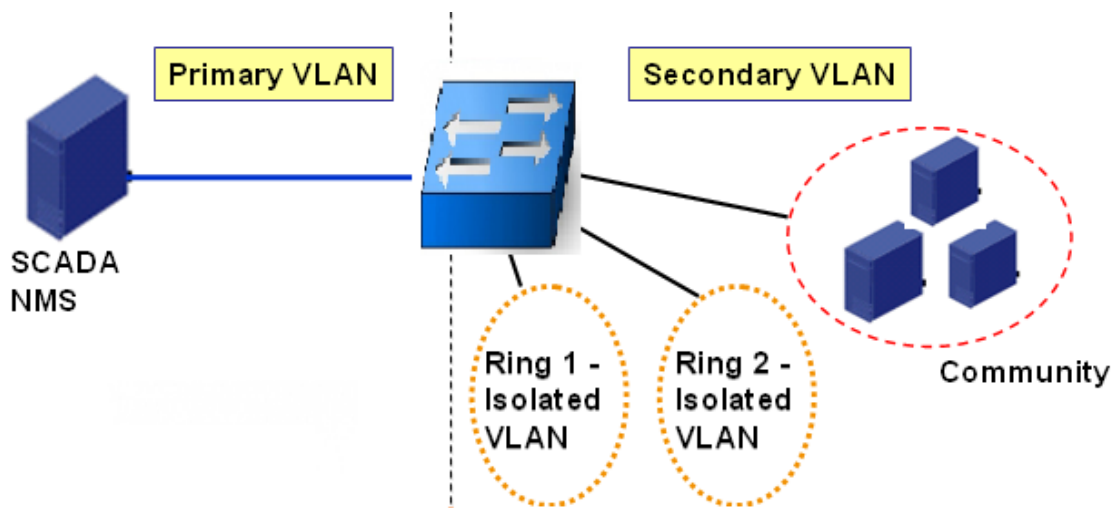

Private VLAN (PVLAN) Configuration group enables you to Configure PVLAN, PVLAN Port and see the PVLAN Information.

Following commands are included in this group:

**4.7.1** PVLAN Configuration

**4.7.2** PVLAN Port Configuration

**4.7.3** CLI Commands of the PVLAN

### 4.7.1 PVLAN Configuration

PVLAN Configuration allows you to assign Private VLAN type. After created VLAN in VLAN Configuraiton page, the available VLAN ID will display here. Choose the Private VLAN types for each VLAN you want configure.

**None:** The VLAN is Not included in Private VLAN.

**Primary:** The VLAN is the Primary VLAN. The member ports can communicate with secondary ports.

**Isolated:** The VLAN is the Isolated VLAN. The member ports of the VLAN are isolated.

The screenshot shows the 'PVLAN Configuration' interface. On the left is a tree view with categories like STP, MSTP, Multiple Super Ring, VLAN, Private VLAN, Traffic Prioritization, Multicast Filtering, and SNMP. Under 'Private VLAN', 'PVLAN Configuration' is selected. On the right, the 'Private VLAN Configuration' table is displayed:

VLAN ID	Private VLAN Type
2	Primary
3	Isolated
4	Community
5	None

Below the table is an 'Apply' button.

**Community:** The VLAN is the Community VLAN. The member ports of the VLAN can communicate with each other.

#### 4.7.2 PVLAN Port Configuration

PVLAN Port Configuration page allows configure Port Configuration and Private VLAN Association.

##### Private VLAN Association

**Secondary VLAN:** After the Isolated and Community VLAN Type is assigned in Private VLAN Configuration page, the VLANs are belonged to the Secondary VLAN and displayed here.

**Primary VLAN:** After the Primary VLAN Type is assigned in Private VLAN Configuration page, the secondary VLAN can associate to the Primary VLAN ID. Select the Primary VLAN ID here.

**Note:** Before configuring PVLAN port type, the Private VLAN Association should be done first.

## **Port Configuraion**

### **PVLAN Port Type :**

**Normal:** The Normal port is None PVLAN ports, it remains its original VLAN setting.

**Host:** The Host type ports can be mapped to the Secondary VLAN.

**Promiscuous:** The promiscuous port can be associated to the Primary VLAN.

**VLAN ID:** After assigned the port type, the web UI display the available VLAN ID the port can associate to.

For example:

**1. VLAN Create:** VLAN 2-5 are created in VLAN Configuration page.

**2. Private VLAN Type:** VLAN 2-5 has its Private VLAN Type configured in Private VLAN Configuration page.

VLAN 2 is belonged to Primary VLAN.

VLAN 3-5 are belonged to secondary VLAN (Isolated or Community).

**3. Private VLAN Association:** Associate VLAN 3-5 to VLAN 2 in Private VLAN Association first.

### **4. Private VLAN Port Configuraiton**

VLAN 2 – Primary -> The member port of VLAN 2 is promiscuous port.

VLAN 3 – Isolated -> The Host port can be mapped to VLAN 3.

VLAN 4 – Community -> The Host port can be mapped to VLAN 3.

VLAN 5 – Community -> The Host port can be mapped to VLAN 3.

### **5. Result:**

VLAN 2 -> VLAN 3, 4, 5; member ports can communicate with ports in secondary VLAN.

VLAN 3 -> VLAN 2, member ports are isolated, but it can communicate with member port of VLAN 2..

VLAN 4 -> VLAN 2, member ports within the community can communicate with each other and communicate with member port of VLAN 2.

VLAN 5 -> VLAN 2, member ports within the community can communicate with each other and communicate with member port of VLAN 2.

## PVLAN Port Configuration

### Port Configuration

Port	PVLAN Port Type	VLAN ID
1	Normal	None
2	Normal	None
3	Normal	None
4	Normal	None
5	Normal	None
6	Normal	None
7	Host	5
8	Host	4
9	Host	3
10	Promiscuous	2

Apply

### Private VLAN Association

Secondary VLAN	Primary VLAN
3	2
4	2
5	2

### 4.7.3 Private VLAN Information

This page allows you to see the Private VLAN information.

## PVLAN Information

### Private VLAN Information

Primary VLAN	Secondary VLAN	Secondary VLAN Type	Port
2	3	Isolated	10,9
2	4	Community	10,8
2	5	Isolated	10,7

Reload

### 4.7.4 CLI Command of the PVLAN

Command Lines of the Private VLAN configuration

Feature	Command Line
<b>Private VLAN Configuration</b>	
Create VLAN	Switch(config)# vlan 2 vlan 2 success Switch(config-vlan)# end        End current mode and change to enable mode exit        Exit current mode and down to previous mode list        Print command list name        Assign a name to vlan no         no private-vlan    Configure a private VLAN
Private VLAN Type	<b>Go to the VLAN you want configure first.</b> Switch(config)# vlan (VID)
Choose the Types	Switch(config-vlan)# private-vlan community    Configure the VLAN as an community private VLAN isolated     Configure the VLAN as an isolated private VLAN primary      Configure the VLAN as a primary private VLAN
Primary Type	Switch(config-vlan)# private-vlan primary <cr>
Isolated Type	Switch(config-vlan)# private-vlan isolated <cr>
Community Type	Switch(config-vlan)# private-vlan community <cr>
<b>Private VLAN Port Configuraiton</b>	
Go to the port configuraiton	Switch(config)# interface (port_number, ex: gi26) Switch(config-if)# switchport private-vlan host-association    Set the private VLAN host association mapping             map primary VLAN to secondary VLAN
Private VLAN Port Type	Switch(config-if)# switchport mode private-vlan    Set private-vlan mode Switch(config-if)# switchport mode private-vlan host                Set the mode to private-vlan host promiscuous        Set the mode to private-vlan promiscuous
Promiscuous Port Type	Switch(config-if)# switchport mode private-vlan promiscuous <cr>
Host Port Type	Switch(config-if)# switchport mode private-vlan host <cr>

Private VLAN Port Configuration PVLAN Port Type	Switch(config)# interface gi26
Host Association primary to secondary  (The command is only available for host port.)	Switch(config-if)# switchport mode private-vlan host  Switch(config-if)# switchport private-vlan host-association <2-4094> Primary range VLAN ID of the private VLAN port association Switch(config-if)# switchport private-vlan host-association 2 <2-4094> Secondary range VLAN ID of the private VLAN port association Switch(config-if)# switchport private-vlan host-association 2 3
Mapping primary to secondary VLANs  (This command is only available for promiscuous port)	Switch(config)# interface gi27  Switch(config-if)# switchport mode private-vlan promiscuous  Switch(config-if)# switchport private-vlan mapping 2 add 3 Switch(config-if)# switchport private-vlan mapping 2 add 4 Switch(config-if)# switchport private-vlan mapping 2 add 5
<b>Private VLAN Information</b>	
Private VLAN Information	Switch# show vlan private-vlan FLAGS:       I -> Isolated               P -> Promiscuous C -> Community Primary Secondary Type               Ports ----- 2        3        Isolated       gi27(P),gi26(I) 2        4        Community      gi27(P),gi25(C) 2        5        Community      gi27(P),fa7(C),gi26(I) 10       -        -               -
PVLAN Type	Switch# show vlan private-vlan type Vlan Type               Ports ----- 2    primary        gi27 3    isolated       gi26 4    community     gi25 5    community     fa7,gi26 10   primary        -
Host List	Switch# show vlan private-vlan port-list Ports Mode            Vlan ----- 1    normal            - 2    normal            - 3    normal            - 4    normal            - 5    normal            - 6    normal            - 7    host             5 8    host             4

	9 host 3
	10 promiscuous 2
Running Config Information	Switch# show run Building configuration...
Private VLAN Type	Current configuration: hostname Switch vlan learning independent ! vlan 1 ! vlan 2 private-vlan primary ! vlan 3 private-vlan isolated ! vlan 4 private-vlan community ! vlan 5 private-vlan community ! ..... .....
Private VLAN Port Information	interface fastethernet7 switchport access vlan add 2,5 switchport trunk native vlan 5 switchport mode private-vlan host switchport private-vlan host-association 2 5 ! interface gigabitethernet25 switchport access vlan add 2,4 switchport trunk native vlan 4 switchport mode private-vlan host switchport private-vlan host-association 2 4 ! interface gigabitethernet26 switchport access vlan add 2,5 switchport trunk native vlan 5 switchport mode private-vlan host switchport private-vlan host-association 2 3 ! interface gigabitethernet27 switchport access vlan add 2,5 switchport trunk native vlan 2 switchport mode private-vlan promiscuous switchport private-vlan mapping 2 add 3-5 ..... .....

## 4.8 Traffic Prioritization

Quality of Service (QoS) provides traffic prioritization mechanism and can also help to alleviate congestion problems and ensure high-priority traffic is delivered first. This section allows you to configure Traffic Prioritization settings for each port with regard to setting priorities.

QoS supports four physical queues, weighted fair queuing (WRR) and Strict Priority scheme, which follows 802.1p COS tag and IPv4 TOS/DiffServ information to prioritize the traffic of your industrial network.

Following commands are included in this chapter:

### 4.8.1 QoS Setting

### 4.8.2 CoS-Queue Mapping

### 4.8.3 DSCP-Queue Mapping

### 4.8.4 CLI Commands of the Traffic Prioritization

### 4.8.1 QoS Setting

**QoS Setting**

**Queue Scheduling**

Use a Round Robin scheme  
 Use a Strict Priority scheme  
 Use Weighted Round Robin scheme

Queue	0	1	2	3	4	5	6	7
Weight	1	1	1	1	1	1	1	1

**Port Setting**

Port	Priority
1	0
2	0
3	0
4	0
5	0
6	0
7	0
8	0
9	0
10	0

## Queue Scheduling

You can select the Queue Scheduling rule as follows:

**Use a Round Robin scheme.** The Round Robin scheme means all the priority has the same privilege, the traffic is forward cyclic from highest to lowest.

**Use a strict priority scheme.** Packets with higher priority in the queue will always be processed first, except that there is no packet with higher priority.

**Use Weighted Round Robin scheme.** This scheme allows users to assign new weight ratio for each class. The 10 is the highest ratio. The ratio of each class is as below:

**$Wx / W0 + W1 + W2 + W3 + W4 + W5 + W6 + W7$  (Total volume of Queue 0-7)**

## Port Setting

**Priority** column is to indicate default port priority value for untagged or priority-tagged frames. When the switch receives the frames, the switch will attach the value to the CoS field of the incoming VLAN-tagged packets. You can enable 0,1,2,3,4,5,6 or 7 to the port.

Default priority type is **COS**. The system will provide default COS-Queue table to which you can refer for the next command.

After configuration, press **Apply** to enable the settings.

### 4.8.2 CoS-Queue Mapping

This page is to change CoS values to Physical Queue mapping table. The switch supports eight physical queues and the users should therefore assign how to map CoS value to the level of the physical queue.

CoS	0	1	2	3	4	5	6	7
Queue	0	1	2	3	4	5	6	7

Note: Queue 7 is the highest priority queue in using Strict Priority scheme.

Apply

After configuration, press **Apply** to enable the settings.

### 4.8.3 DSCP-Queue Mapping

This page is to change DSCP values to Physical Queue mapping table. The switch supports eight physical queues and the users should therefore assign how to map

DSCP value to the level of the physical queue. The users can freely change the mapping table to follow the upper layer 3 switch or routers' DSCP setting.

## Traffic Prioritization

### DSCP-Queue Mapping

DSCP	0	1	2	3	4	5	6	7
Queue	7	0	0	0	0	0	0	0
DSCP	8	9	10	11	12	13	14	15
Queue	1	1	1	1	1	1	1	1
DSCP	16	17	18	19	20	21	22	23
Queue	2	2	2	2	2	2	2	2
DSCP	24	25	26	27	28	29	30	31
Queue	3	3	3	3	3	3	3	3
DSCP	32	33	34	35	36	37	38	39
Queue	4	4	4	4	4	4	4	4
DSCP	40	41	42	43	44	45	46	47
Queue	5	5	5	5	5	5	5	5
DSCP	48	49	50	51	52	53	54	55
Queue	6	6	6	6	6	6	6	6
DSCP	56	57	58	59	60	61	62	63
Queue	7	7	7	7	7	7	7	7

Note: Queue 7 is the highest priority queue in using Strict Priority scheme.

Apply

After configuration, press **Apply** to enable the settings.

#### 4.8.4 CLI Commands of the Traffic Prioritization

Command Lines of the Traffic Prioritization configuration

Feature	Command Line
<b>QoS Setting</b>	
Queue Scheduling - Round Robin	Switch(config)# qos queue-sched rr Round Robin sp Strict Priority wrr Weighted Round Robin Switch(config)# qos queue-sched rr The queue scheduling scheme is setting to Round Robin.
Queue Scheduling - Strict Priority	Switch(config)# qos queue-sched sp The queue scheduling scheme is setting to Strict Priority.

Queue Scheduling - WRR	<pre>Switch(config)# qos queue-sched wrr 1 1 1 1 1 1 1 1 The queue scheduling scheme is setting to Weighted Round Robin.</pre>
Port Setting - Priority	<pre>Switch(config)# interface <b>fa1</b> Switch(config-if)# qos priority DEFAULT-PRIORITY Assign an priority (7 highest) Switch(config-if)# qos priority 7 The default port priority value is set 7 ok.</pre> <p><b>Note: When change the port setting, you should Select the specific port first. Ex: fa1 means fast Ethernet port 1.</b></p>
Display - Queue Scheduling	<pre>Switch# show qos queue-sched QoS queue scheduling scheme : Weighted Round Robin (Use an 8,4,2,1 weight)</pre>
Display - Port Setting	<pre>Switch# show qos port-priority Port Default Priority : Port Priority R. -----+--          0 7    0 8    0 9    0 10   0 ... 26   0 27   0 28   0</pre>
<b>CoS-Queue Mapping</b>	
Format	<pre>Switch(config)# qos cos-map PRIORITY Assign an priority (7 highest) Switch(config)# qos cos-map 1 QUEUE Assign an queue (0-7)</pre> <p><b>Note: Format: qos cos-map priority_value queue_value</b></p>

Map CoS 0 to Queue 0	Switch(config)# qos cos-map 0 0 The CoS to queue mapping is set ok.
Map CoS 1 to Queue 1	Switch(config)# qos cos-map 1 1 The CoS to queue mapping is set ok.
Map CoS 2 to Queue 2	Switch(config)# qos cos-map 2 2 The CoS to queue mapping is set ok.
Map CoS 3 to Queue 3	Switch(config)# qos cos-map 3 3 The CoS to queue mapping is set ok.
Map CoS 4 to Queue 4	Switch(config)# qos cos-map 4 4 The CoS to queue mapping is set ok.
Map CoS 5 to Queue 5	Switch(config)# qos cos-map 5 5 The CoS to queue mapping is set ok.
Map CoS 6 to Queue 6	Switch(config)# qos cos-map 6 6 The CoS to queue mapping is set ok.
Map CoS 7 to Queue 7	Switch(config)# qos cos-map 7 7 The CoS to queue mapping is set ok.
Display - CoS-Queue mapping	Switch# sh qos cos-map CoS to Queue Mapping : CoS Queue R. ---- + ---- 6 7 7
<b>DSCP-Queue Mapping</b>	
Format	Switch(config)# qos dscp-map PRIORITY Assign an priority (63 highest) Switch(config)# qos dscp-map 0 QUEUE Assign an queue (0-7)  <b>Format: qos dscp-map priority_value queue_value</b>
Map DSCP 0 to Queue 1	Switch(config)# qos dscp-map 0 1 The TOS/DSCP to queue mapping is set ok.
Display - DSCO-Queue mapping	Switch# show qos dscp-map DSCP to Queue Mapping : (dscp = d1 d2)

	<pre> d2  0 1 2 3 4 5 6 7 8 9 d1   -----+----- 0   0 0 0 0 0 0 0 0 1 1 R. 1   1 1 1 1 1 1 2 2 2 2   2 2 2 2 3 3 3     3 3 3   3 3 4 4 4 4 4 4 4 4   5 5 5 5 5     5 5 5 6 5   6 6 6 6 6 6 7 7 7 7 6   7 7 7 7 </pre>
--	--

## 4.9 Multicast Filtering

For multicast filtering, the switch uses IGMP Snooping technology. IGMP (Internet Group Management Protocol) is an Internet Protocol that provides a way for internet device to report its multicast group membership to adjacent routers. Multicasting allows one computer on the internet to send data to a multitude of other computers that have identified themselves as being interested in receiving the originating computers data.

Multicasting is useful for such applications as updating the address books of mobile computer users in the field, sending out newsletters to a distribution list, and broadcasting streaming media to an audience that has tuned into the event by setting up multicast group membership.

In effect, IGMP Snooping manages multicast traffic by making use of switches, routers, and hosts that support IGMP. Enabling IGMP Snooping allows the ports to detect IGMP queries, report packets, and manage multicast traffic through the switch. IGMP has three fundamental types of messages, as shown below:

Message	Description
Query	A message sent from the querier (an IGMP router or a switch) which asks for a response from each host that belongs to the multicast group.
Report	A message sent by a host to the querier to indicate that the host wants to be or is a member of a given group indicated in the report message.
Leave Group	A message sent by a host to the querier to indicate that the host has quit as a member of a specific multicast group.

You can enable **IGMP Snooping** and **IGMP Query** functions here. You will see the information of the IGMP Snooping function in this section, including different multicast groups' VID and member ports, and IP multicast addresses that range from 224.0.0.0 to 239.255.255.255.

In this section, Force filtering can determined whether the switch flooding unknown multicast traffic or not.

Following commands are included in this section:

### 4.9.1 IGMP Snooping

### 4.9.2 IGMP Query

### 4.9.3 Unknown Multicast

### 4.9.4 CLI Commands of the Multicast Filtering

### 4.9.1 IGMP Snooping

This page is to enable IGMP Snooping feature, assign IGMP Snooping for specific VLAN, and view IGMP Snooping table from dynamic learnt or static manual key-in. The switch support IGMP snooping V1/V2/V3 automatically and IGMP query V1/V2.

**IGMP Snooping**, you can select **Enable** or **Disable** here. After enabling IGMP Snooping, you can then enable IGMP Snooping for specific VLAN. You can enable IGMP Snooping for some VLANs so that some of the VLANs will support IGMP Snooping and others won't.

To assign IGMP Snooping to VLAN, please select the **checkbox** of VLAN ID or select **Select All** checkbox for all VLANs. Then press **Enable**. In the same way, you can also **Disable** IGMP Snooping for certain VLANs.

**IGMP Snooping**

IGMP Snooping Disable ▼

Apply

	VID	IGMP Snooping
<input checked="" type="checkbox"/>	1	Disabled
<input type="checkbox"/>	2	Disabled

Select All

Enable    Disable

**IGMP Snooping Table:** In the table, you can see multicast group IP address, VLAN ID it belongs to, and member ports of the multicast group. The switch supports 256 multicast groups. Click on **Reload** to refresh the table.

## IGMP Snooping Table

IP Address	VID	1	2	3	4	5	6	7	8	9	10

Reload

### 4.9.2 IGMP Query

**IGMP Query**

**IGMP Query on the Management VLAN**

Version	Version 2
Query Interval(s)	
Query Maximum Response Time(s)	

Apply

This page allows users to configure **IGMP Query** feature. Since the switch can only be configured by member ports of the management VLAN, IGMP Query can only be enabled on the management VLAN. If you want to run IGMP Snooping feature in several VLANs, you should notice that whether each VLAN has its own IGMP Querier first.

The IGMP querier periodically sends query packets to all end-stations on the LANs or VLANs that are connected to it. For networks with more than one IGMP querier, a switch with the lowest IP address will become the IGMP querier.

In IGMP Query selection, you can select V1, V2 or Disable. **V1** means IGMP V1 General Query and **V2** means IGMP V2 General Query.. The query will be forwarded to all multicast groups in the VLAN. **Disable** allows you to disable IGMP Query.

**Query Interval(s):** The period of query sent by querier.

**Query Maximum Response Time:** The span querier detect to confirm there are no more directly connected group members on a LAN.

Once you finish configuring the settings, click on **Apply** to apply your

configuration.

### 4.9.3 Unknown Multicast

This page allows you to decide how to forward the unknown multicast traffic. After enabled IGMP Snooping, the known multicast can be filtered by IGMP Snooping mechanism and forwarded to the member ports of the known multicast groups. The other multicast streams which are not learnt is so-called unknown multicast, the switch decide how to forward them based on the setting of this page.

## Unknown Multicast

### Unknown Multicast

- Send to Query Ports  
 Send to All Ports  
 Discard

Apply

**Send to Query Ports:** The unknown multicast will be sent to the Query ports. The Query port means the port received the IGMP Query packets and it is usually the uplink port on the switch.

**Send to All Ports:** The unknown multicast will be flooded to all ports even if they are not member ports of the groups.

**Discard:** The unknown multicast will be discarded. Non-member ports will not receive the unknown multicast streams.

### 4.9.4 CLI Commands of the Multicast Filtering

Command Lines of the multicast filtering configuration

Feature	Command Line
<b>IGMP Snooping</b>	
IGMP Snooping - Global	Switch(config)# ip igmp snooping IGMP snooping is enabled globally. Please specify on which vlans IGMP snooping enables
IGMP Snooping - VLAN	Switch(config)# ip igmp snooping vlan VLANLIST allowed vlan list all all existed vlan Switch(config)# ip igmp snooping vlan 1-2

	IGMP snooping is enabled on VLAN 1-2.
Disable IGMP Snooping - Global	Switch(config)# no ip igmp snoopin IGMP snooping is disabled globally ok.
Disable IGMP Snooping - VLAN	Switch(config)# no ip igmp snooping vlan 3 IGMP snooping is disabled on VLAN 3.
Display - IGMP Snooping Setting	Switc evic ip igmp interface vlan1 enabled: Yes version: IGMPv1 query-interval; 125s query-max-response-time: 10s  Switc evic ip igmp snooping IGMP snooping is globally enabled Vlan1 is IGMP snooping enabled Vlan2 is IGMP snooping enabled Vlan3 is IGMP snooping disabled
Display - IGMP Table	Switc evic ip igmp snooping multicast all VLAN IP Address Type Ports ----- ----- 1 239.192.8.0 IGMP fa6, 1 239.255.255.250 IGMP fa6,
<b>IGMP Query</b>	
IGMP Query V1	Switch(config)# int vlan 1 (Go to management VLAN) Switch(config-if)# ip igmp v1
IGMP Query V2	Switch(config)# int vlan 1 (Go to management VLAN) Switch(config-if)# ip igmp
IGMP Query version	Switch(config-if)# ip igmp version 1 Switch(config-if)# ip igmp version 2
Disable	Switch(config)# int vlan 1 Switch(config-if)# no ip igmp
Display	Switc evic ip igmp

	<pre>interface vlan1   enabled: Yes   version: IGMPv2   query-interval: 125s   query-max-response-time: 10s  Switch# show running-config ... ! interface vlan1   ip address 192.168.2.200/24   ip igmp   no shutdown ! .....</pre>
<b>Unknown Multicast</b>	
Send Unknown Multicast to Query Ports	<pre>Switch(config)# ip igmp snooping   source-only-learning IGMP Snooping Source-Only-Learning enabled</pre>
Send Unknown Multicast to All Ports	<pre>Switch(config)# no ip igmp snooping   source-only-learning IGMP Snooping Source-Only-Learning disabled  Switch(config)# no mac-address-table multicast   filtering Flooding unknown multicast addresses ok!</pre>
Discard All Unknown Multicast	<pre>Switch(config)# mac-address-table multicast   filtering Filtering unknown multicast addresses ok!</pre>

## 4.10 SNMP

Simple Network Management Protocol (SNMP) is a protocol used for exchanging management information between network devices and is a member of the TCP/IP protocol suite. The switch support SNMP v1 and v2c and V3.

An SNMP managed network consists of two main components: agents and a manager. An agent is a management software module that resides in a managed switch. An agent translates the local management information from the managed device into a SNMP compatible format. The manager is the console through the network.

Following commands are included in this chapter:

### 4.10.1 SNMP Configuration

### 4.10.2 SNMPv3 Profile

### 4.10.3 SNMP Traps

### 4.10.4 SNMP CLI Commands for SNMP

#### 4.10.1 SNMP Configuration

This page allows users to configure SNMP V1/V2c Community. The community string can be viewed as the password because SNMP V1/V2c doesn't request you to enter password before you try to access SNMP agent.

The community includes two privileges, Read Only and Read and Write.

With **Read Only** privilege, you only have the ability to read the values of MIB tables. Default community string is Public.

With **Read and Write** privilege, you have the ability to read and set the values of MIB tables. Default community string is Private.

The switch allows users to assign four community strings. Type the community string and select the privilege and then press **Apply**.

**Note:** When you first install the device in your network, we highly recommend you to change the community string. Since most SNMP management application uses Public and Private as their default community name, this might be the leakage of the network security.

**SNMP**

**SNMP V1/V2c Community**

Community String	Privilege
public	Read Only
private	Read and Write
	Read Only
	Read Only

Apply

#### 4.10.2 SNMP V3 Profile

SNMP V3 can provide more security functions when the user performs remote management through SNMP protocol. It delivers SNMP information to the administrator with user authentication; all of data between the switch and the administrator are encrypted to ensure secure communication.

**SNMP V3 Profile**

**SNMP V3**

User Name	
Security Level	None
Auth. Level	MD5
Auth. Password	
DES Password	

Add

**SNMP V3 Users**

User Name	Security Level	Auth. Level	Auth. Password	DES Password

Remove Reload

**Security Level:** Here the user can select the following levels of security: None, Authentication, and “Authentication and Privacy”.

**Auth. Protocol:** Here the user can select either MD5 (Message-Digest algorithm 5) or SHA (Secure Hash Algorithm). MD5 is a widely used cryptographic hash function with a 128-bit hash value. SHA (Secure Hash Algorithm) hash functions refer to five Federal Information Processing Standard-approved algorithms for computing a condensed digital representation. *The switch* provides two user

authentication protocols in MD5 and SHA. You will need to configure SNMP v3 parameters for your SNMP tool with the same authentication method.

**Auth. Password:** Here the user enters the SNMP v3 user authentication password.

**DES Encryption Password:** Here the user enters the password for SNMP v3 user DES Encryption.

### 4.10.3 SNMP Traps

SNMP Trap is the notification feature defined by SNMP protocol. All the SNMP management applications can understand such trap information. So you don't need to install new application to read the notification information.

This page allows users to **Enable SNMP Trap**, configure the **SNMP Trap server IP**, **Community** name, and trap **Version V1 or V2**. After configuration, you can see the change of the SNMP pre-defined standard traps and Westermo pre-defined traps. The pre-defined traps can be found in Westermo private MIB.

**SNMP Trap**

SNMP Trap: Disable

Apply

**SNMP Trap Server**

Server IP: 192.168.2.110

Community: private

Version:  V1  V2c

Add

**Trap Server Profile**

Server IP	Community	Version
192.168.2.100	public	V2c

Remove Reload

### 4.10.4 CLI Commands of the SNMP

Command Lines of the SNMP configuration

Feature	Command Line
---------	--------------

<b>SNMP Community</b>	
Read Only Community	Switch(config)# snmp-server community public ro community string add ok
Read Write Community	Switch(config)# snmp-server community private rw community string add ok
<b>SNMP Trap</b>	
Enable Trap	Switch(config)# snmp-server enable trap Set SNMP trap enable ok.
SNMP Trap Server IP without specific community name	Switch(config)# snmp-server host 192.168.2.33 SNMP trap host add OK.
SNMP Trap Server IP with version 1 and community	Switch(config)# snmp-server host 192.168.2.33 version 1 private SNMP trap host add OK. <b>Note: private is the community name, version 1 is the SNMP version</b>
SNMP Trap Server IP with version 2 and community	Switch(config)# snmp-server host 192.168.2.33 version 2 private SNMP trap host add OK.
Disable SNMP Trap	Switch(config)# no snmp-server enable trap Set SNMP trap disable ok.
Display	Switch# sh snmp-server trap SNMP trap: Enabled SNMP trap community: public  Switch# show running-config ..... snmp-server community public ro snmp-server community private rw snmp-server enable trap snmp-server host 192.168.2.33 version 2 admin snmp-server host 192.168.2.33 version 1 admin .....

## 4.11 Security

The switch provides several security features for you to secure your connection. The features include Port Security and IP Security. Following commands are included in this section:

### 4.11.1 Filter Set (Access Control List)

#### 4.11.2 IEEE 802.1x

#### 4.11.3 CLI Commands of the Security

### 4.11.1 Filter Set (Access Control List)

The Filter Set is known as Access Control List feature. There are two major types, one is MAC Filter and the other one is IP Filter. ACE is short of Access Control Entry, user defines the Permit or Deny rule for specific IP/MAC address or IP groups by network mask in each ACE. One ACL may include several ACEs, the system checks the ACEs one after one and forward based on the result. Once the rules conflict, the old entry is selected as the forward rule.

**Filter Set**

**Add Filter**

MAC Filter,      Name:

IP Filter,      ID/Name:

(1-99)IP standard access list  
(100-199)IP extended access list  
(1300-1999)IP standard access list(expanded range)  
(2000-2699)IP extended access list(expanded range)

IP Filter ID/Name	Mac Filter Name	Ingress Ports
-	server_A_MAC	
server_B_IP	-	

Apply    Reload    Edit    Remove

Type the **Name** when select **MAC Filter**, type **ID/Name** when select **IP Filter**. The ID for IP access list is listed as below of the field. Click **Add** to add the rule. Click **Edit** to edit the content for the rule. After configured, click **Apply** to apply all the rules. **Reload** to reload setting. **Remove** to remove one of the entries.

#### MAC Filter (Port Security):

## Filter Rule

**Filter Type: MAC Extended**

Filter ID/Name:	server_MAC	Action:	Permit
Source Address:	. .	Destination Address:	. .
Source Wildcard:	Host	Destination Wildcard:	Host
Egress Port:	--		

Source / Wildcard	Destination / Wildcard	Action	Egress Port
0007.7C00.0000	0007.7C00.0001	Permit	

The MAC Filter allows user to define the Access Control List for specific MAC address or a group of MAC addresses.

**Filter ID/Name:** The name for this MAC Filter entry.

**Action:** **Permit** to permit traffic from specified sources. **Deny** to deny traffic from those sources.

**Source/Destination Address:** Type the MAC address you want configure, the format is "AABB.CCDD.EEFF". Example: "Source to Destination" is "0007.7c00.0000 to 0007.7c00.0002".

**Source/Destination Wildcard:** This command allows user to define single host or a group of hosts based on the wildcard. Some of the allowance examples are as below:

Wildcard	Bit	Number of allowance	Note
Any	1111.1111.1111	All	
Host		1	Only the Source or Destination.
0000.0000.0003	0000.0000.000(00000011)	3	
0000.0000.0007	0000.0000.000(00000111)	7	
0000.0000.000F	0000.0000.000(11111111)	15	

Source Wildcard:	Host
Egress Port:	Any
	Host
	0000.0000.0001
	0000.0000.0003
	0000.0000.0007
	0000.0000.000F
	0000.0000.001F
	0000.0000.003F

Add      Modify

**Egress Port:** Bind the MAC Filter rule to specific front port.

Egress Port:	--
	--
	fastethernet1
	fastethernet2
	fastethernet3
	fastethernet4
	fastethernet5
	fastethernet6
	fastethernet7

Add      Modify

Once you finish configuring the ACE settings, click on **Add** to apply your configuration. You can see below screen is shown.

Example of the below Entry:

*Permit Source MAC "0007.7c00.0000" to Destination MAC "0007.7c00.0002".*

*The Permit rule is egress rule and it is bind to Gigabit Ethernet Port 25.*

Source / Wildcard	Destination / Wildcard	Action	Egress Port
0007.7C00.0000	0007.7C00.0001	Permit	

Apply      Reload

Once you finish configuring the settings, click on **Apply** to apply your configuration.

### IP Filter:

Type **ID/Name** when select **IP Filter**. The ID for IP access list is listed as below of the field. You can also type ACL name in this field, it goes to IP Extended mode setting and support both IP Standard and IP Extended mode depend on the

setting. Click **Add** to add the rule. Click **Edit** to edit the content for the rule. After configured, click **Apply** to apply all the rules. **Reload** to reload setting. **Remove** to remove one of the entries.

Example:

## Filter Set

**Add Filter**

MAC Filter,
 Name:

IP Filter,
 ID/Name:

(1~99)IP standard access list  
 (100~199)IP extended access list  
 (1300~1999)IP standard access list(expanded range)  
 (2000~2699)IP extended access list(expanded range)

IP Filter ID/Name	Mac Filter Name	Ingress Ports
1	-	
100	-	
1300	-	
2000	-	

**IP Standard** Access List: This kind of ACL allows user to define filter rules according to the source IP address.

**IP Extended** Access List: This kind of ACL allows user to define filter rules according to the source IP address, destination IP address, Source TCP/UDP port, destination TCP/UDP port and ICMP type and code.

Click **Edit** to configure the IP Filter Rules.

## Filter Rule

Filter Type: IP Extended

Filter ID/Name:	100	Action:	Permit
Source Address:	192.168.2.2	Destination Address:	192.168.2.200
Source Wildcard:	Host	Destination Wildcard:	Host
Protocol:	IP		
Source Port:		Destination Port:	
Source Port Wildcard:	Any	Destination Port Wildca...	Any
Egress Port:	-		

Add    Modify    Remove

SourceIP	Destinati...	Source...	Destinati...	Src P...	Dst P...	Proto...	Action	Egress Port	ICMP Message type
192.168.2.2	192.168.2....	Host	Host	-	-	IP	Permit		

Apply    Reload

**Filter ID/Name:** The ID or the name for this IP Filter entry.

**Action:** **Permit** to permit traffic from specified sources. **Deny** to deny traffic from those sources.

**Source/Destination Address:** Type the source/destination IP address you want configure.

Filter ID/Name:	100
Source Address:	192.168.2.2
Source Wildcard:	Host
Protocol:	Any
Source Port:	Host
Source Port Wildcard:	0.0.0.1
Egress Port:	0.0.0.3
	0.0.0.7
	0.0.0.15
	0.0.0.31
	0.0.0.63

Add    Modify

**Source/Destination Wildcard:** This command allows user to define single host or a group of hosts based on the wildcard. Some of the allowance examples are as below:

Wildcard	Bit	Number of allowance	Note
Any	11111111.11111111. 11111111.11111111	All	All IP addresses. Or a mask: 255.255.255.255
Host	0.0.0.0	1	Only the Source or Destination host.
0.0.0.3	0.0.0.(00000011)	3	
0.0.0.7	0.0.0.(00000111)	7	
0.0.0.15	0.0.0.(11111111)	15	
....			

**Note:** The mask is a wildcard mask: the high-order bits of the mask that are binary zeros determine how many corresponding high-order bits in the IP address are significant. The selected action applies to any source address with these high-order bits.

**Protocol:** Select a protocol you want associate with the filter. The field includes IP, TCP, UDP or ICMP type.

**Destination Port:** TCP/UDP port of the Destination Port field.

**ICMP Type:** The ICMP Protocol Type range from 1 ~ 255.

**ICMP Code:** The ICMP Protocol Code range from 1 ~ 255.

**Egress Port:** Bind this Filter to selected egress port.

Click the **Add** button to add the rule to the Filter. Click the **Remove** button to remove the selected rule from Filter. Click the **Modify** button to edit the rule which you selected. Click the **Reload** button to reload the rule table.

Click the **Apply** button to apply the Filter configurations.

# Filter Attach

**Filter attach/detach**

Filter ID/Name:

Port	<input type="checkbox"/>	IP Filter	MAC Filter
1	<input type="checkbox"/>	--	--
2	<input type="checkbox"/>	--	--
3	<input type="checkbox"/>	--	--
4	<input type="checkbox"/>	--	--
5	<input type="checkbox"/>	--	--
6	<input type="checkbox"/>	--	--
7	<input type="checkbox"/>	--	--
8	<input type="checkbox"/>	--	--
9	<input checked="" type="checkbox"/>	<input type="text" value="100"/>	--
10	<input type="checkbox"/>	--	--

After configured the ACL filter rules, remember associate this filter with the physical ports. Then the port has the capability to filter traffic/attach based on the packets lost.

### 4.11.2 IEEE 802.1x

#### 802.1X configuration

IEEE 802.1X is the protocol that performing authentication to obtain access to IEEE 802 LANs. It is port-base network access control and the switch could control which connection should be available or not.

**System AuthControl:** To enable or disable the 802.1x authentication.

**Authentication Method:** Radius is a authentication server that provides authentication, with this method, user must connect the switch to to the Radius server. If user selects Local for the authentication method, the switch will use the local user data base which can be created in this page for authentication.

**Radius Server IP:** The IP address of the Radius server

**Shared Key:** The password for communicate between switch and Radius Server.

**Server Port:** UDP port of the Radius server.

**Accounting Port:** Port for packets that contain the information of account login or logout.

**Secondary Radius Server IP:** Secondary Radius Server could be set in case of the primary radius server down.

**Local Radius User:** The user can add Account/Password for local authentication.

**Local Radius User List:** This is a list shows the account information, User also can remove selected account Here.

### 802.1x Port Configuration

After the configuration of Radius Server or Local user list, user also need configure the authentication mode, authentication behavior, applied VLAN for each port and permitted communication. The following information will explain the port configuration.

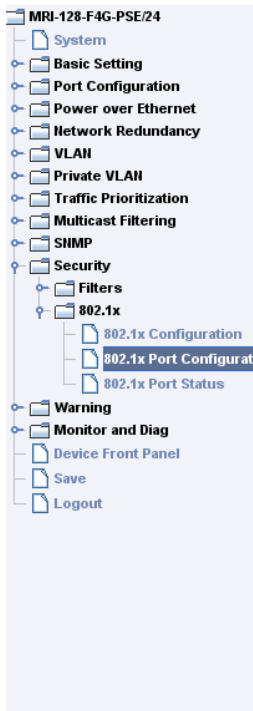

## 802.1x Port-Based Network Access Control Port Configuration

### 802.1x Port Configuration

Port	Port Control	Reauthentication	Max Request	Guest VLAN	Host Mode	Admin Control Direction
1	Force Authorized	Disable	2	0	Single	Both
2	Force Authorized	Disable	2	0	Single	Both
3	Force Authorized	Disable	2	0	Single	Both
4	Force Authorized	Disable	2	0	Single	Both
5	Force Authorized	Disable	2	0	Single	Both
6	Force Authorized	Disable	2	0	Single	Both

### 802.1x Timeout Configuration

Port	Re-Auth Period(s)	Quiet Period(s)	Tx Period(s)	Supplicant Timeout(s)	Server Timeout(s)
1	3600	60	30	30	30
2	3600	60	30	30	30
3	3600	60	30	30	30
4	3600	60	30	30	30
5	3600	60	30	30	30
6	3600	60	30	30	30

Once you finish configuring the settings, click on **Apply** to apply your configuration.

**Port control:** Force Authorized means this port is authorized; the data is free to in/out. Force unauthorized just opposite, the port is blocked. If users want to control this port with Radius Server, please select Auto for port control.

**Reauthentication:** If enable this field, switch will ask client to re-authenticate. The default time interval is 3600 seconds.

**Max Request:** the maximum times that the switch allow client request.

**Guest VLAN:** VLAN ID 0 to 4094 is available for this field. If this field is set to 0, that means the port is blocked for failed authentication. Otherwise, the port will be set to a Guest VLAN.

**Host Mode:** if there are more than one device connected to this port, set the Host Mode to single means only the first PC authenticate success can access this port. If this port is set to multi, all the devices can access this port once any one of them pass the authentication.

**Control Direction:** determined devices can end data out only or both send and receive.

**Re-Auth Period:** Control the Re-authentication time interval, 1~65535 is available.

**Quiet Period:** When authentication failed, Switch will wait for a period and try to communicate with radius server again.

**Tx period:** The time interval of authentication request.

**Supplicant Timeout:** the timeout for the client authenticating

**Sever Timeout:** The timeout for server response for authenticating.

Click **Initialize Selected** to set the authorize state of selected port to initialize status.

Click **Reauthenticate Selected** to send EAP Request to supplicant to request reauthentication.

Click **Default Selected** to reset the configurable 802.1x parameters of selected port to the default values.

### 802.1X Port Status

The user can observe the port status for Port control, Authorize Status, Authorized Supplicant and Oper Control Direction on each port.

**802.1x Port-Based Network Access Control Port Status**

Port	Port Control	Authorize Status	Authorized Supplicant	Oper Control Direction
1	Force Authorized	AUTHORIZED	NONE	Both
2	Force Authorized	AUTHORIZED	NONE	Both
3	Force Authorized	AUTHORIZED	NONE	Both
4	Force Authorized	AUTHORIZED	NONE	Both
5	Force Authorized	AUTHORIZED	NONE	Both
6	Force Authorized	AUTHORIZED	NONE	Both
7	Force Authorized	AUTHORIZED	NONE	Both
8	Force Authorized	AUTHORIZED	NONE	Both
9	Force Authorized	AUTHORIZED	NONE	Both
10	Force Authorized	AUTHORIZED	NONE	Both

Reload

### 4.11.3 CLI Commands of the Security

#### Command Lines of the Security configuration

Feature	Command Line
<b>Port Security</b>	
Add MAC	Switch(config)# mac-address-table static 0007.7c01.0101 vlan 1 interface fa1 mac-address-table unicast static set ok!
Port Security	Switch(config)# interface fa1 Switch(config-if)# switchport port-security Disables new MAC addresses learning and aging activities!  <b>Note: Rule: Add the static MAC, VLAN and Port binding first, then enable the port security to stop new MAC learning.</b>

Disable Port Security	Switch(config-if)# no switchport port-security Enable new MAC addresses learning and aging activities!
Display	Switch# show mac-address-table static Destination Address Address Type Vlan Destination Port ----- ----- 0007.7c01.0101 Static 1 fa1
<b>IP Security</b>	
IP Security	Switch(config)# ip security Set ip security enable ok. Switch(config)# ip security host 192.168.2.33 Add ip security host 192.168.2.33 ok.
Display	Switch# show ip security ip security is enabled ip security host: 192.168.10.33
<b>802.1x</b>	
enable  diabile	Switch(config)# dot1x system-auth-control Switch(config)# Switch(config)# no dot1x system-auth-control Switch(config)#
authentic-method	Switch(config)# dot1x authentic-method local Use the local username database for authentication radius Use the Remote Authentication Dial-In User Service (RADIUS) servers for authentication Switch(config)# dot1x authentic-method radius Switch(config)#
radius server-ip	Switch(config)# dot1x radius Switch(config)# dot1x radius server-ip 192.168.2.200 key 1234  RADIUS Server Port number NOT given. (default=1812) RADIUS Accounting Port number NOT given.

	<pre>(default=1813) RADIUS Server IP   : 192.168.2.200 RADIUS Server Key  : 1234 RADIUS Server Port : 1812 RADIUS Accounting Port : 1813 Switch(config)#</pre>
radius server-ip	<pre>Switch(config)# dot1x radius Switch(config)# dot1x radius server-ip 192.168.2.200 key 1234  RADIUS Server Port number NOT given. (default=1812) RADIUS Accounting Port number NOT given. (default=1813) RADIUS Server IP   : 192.168.2.200 RADIUS Server Key  : 1234 RADIUS Server Port : 1812 RADIUS Accounting Port : 1813 Switch(config)#</pre>
radius secondary-server-ip	<pre>Switch(config)# dot1x radius secondary-server-ip 192.168.2.250 key 5678  Port number NOT given. (default=1812) RADIUS Accounting Port number NOT given. (default=1813) Secondary RADIUS Server IP   : 192.168.2.250 Secondary RADIUS Server Key  : 5678 Secondary RADIUS Server Port : 1812 Secondary RADIUS Accounting Port : 1813</pre>
User name/password for authentication	<pre>Switch(config)# dot1x username Westermo passwd Westermo vlan 1</pre>

## 4.12 Warning

The switch provides several types of Warning features for you to remote monitor the status of end devices or the change of your network. The features include Fault Relay, System Log and SMTP E-mail Alert.

Following commands are included in this chapter:

- 4.12.1 Fault Relay
- 4.12.2 Event Selection
- 4.12.3 Syslog Configuration
- 4.12.4 SMTP Configuration
- 4.12.5 CLI Commands

### 4.12.1 Fault Relay

The switch provides one digital output, also known as Relay Output. The relay contacts are energized (open) for normal operation and will close under fault conditions. Fault conditions include Power Failure, Ethernet port Link Failure, Ping Failure and Super Ring Topology Change. You can configure these settings in this Fault Relay Setting and each Relay can be assigned 1 fault condition.

**Relay 1:** Click on checkbox of the Relay 1, then select the Event Type and its parameters.

**Event Type:** Dry Output, Power Failure, Link Failure, Ping Failure and Super Ring Failure. Each event type has its own parameters and should also be configured. Currently, each Relay has one event type.

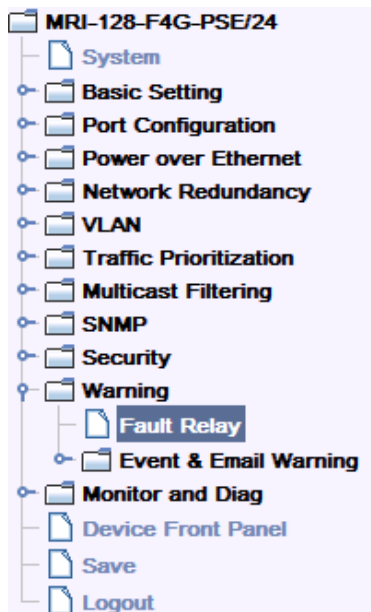

### Fault Relay Setting

<input checked="" type="checkbox"/>	Relay 1
Event Type	Dry Output
On Period(Sec)	Dry Output
Off Period(Sec)	Power Failure
	Link Failure
	Ping Failure
	Super Ring Failure

Apply

Event Type: **Dry Output**

**On Period (Sec):** Type the period time to turn on Relay Output. Available range of

a period is 0-4294967295 seconds.

**Off Period (Sec):** Type the period time to turn off Relay Output. Available range of a period is 0-4294967295 seconds.

**How to configure:** Type turn-on period and turn-off period when the time is reached, the system will turn on or off the Relay Output.

**How to turn On/Off the other device:** Type “1” into the “On period” field and “0” into “Off Period” field and apply the setting, the relay will be triggered to form a close circuit.

To turn off the relay, just type “0” into the “On period” field and “1” into “Off Period” field and apply the setting, the relay will be triggered to form an open circuit.

This function is also available in CLI, SNMP management interface. See the following setting.

<input checked="" type="checkbox"/> <b>Relay 1</b>	
<b>Event Type</b>	Dry Output
<b>On Period(Sec)</b>	1
<b>Off Period(Sec)</b>	0

Turn on the relay output

<input checked="" type="checkbox"/> <b>Relay 1</b>	
<b>Event Type</b>	Power Failure
<b>Power ID</b>	Power DC1
	Power DC1
	Power DC2
	Any

Event Type: **Power Failure**

**Power ID:** Select Power AC, Power DC1, Power DC2 or Any you want to monitor. When the power is shut down or broken, the system will short Relay Out and light the Alarm LED.

Event Type: **Link Failure**

**Link:** Select the port ID you want to monitor.

**How to configure:** Select the checkbox of the Ethernet ports you want to monitor. You can select one or multiple ports. When the selected ports are physically down,

the system will short Relay Output and light the Alarm LED.

<input checked="" type="checkbox"/> Relay 1										
Event Type	Link Failure									
Link	1	2	3	4	5	6	7	8	9	10
	<input type="checkbox"/>	<input type="checkbox"/>	<input type="checkbox"/>	<input type="checkbox"/>	<input type="checkbox"/>	<input type="checkbox"/>	<input type="checkbox"/>	<input type="checkbox"/>	<input type="checkbox"/>	<input type="checkbox"/>
	11	12	13	14	15	16	17	18	19	20
	<input type="checkbox"/>	<input type="checkbox"/>	<input type="checkbox"/>	<input type="checkbox"/>	<input type="checkbox"/>	<input type="checkbox"/>	<input type="checkbox"/>	<input type="checkbox"/>	<input type="checkbox"/>	<input type="checkbox"/>
	21	22	23	24	25	26	27	28		
	<input type="checkbox"/>	<input type="checkbox"/>	<input type="checkbox"/>	<input type="checkbox"/>	<input type="checkbox"/>	<input type="checkbox"/>	<input type="checkbox"/>	<input type="checkbox"/>		

Apply

Event Type: **Ping Failure**

**IP Address:** IP address of the target device you want to ping.

**Reset Time (Sec):** Waiting time to short the relay output.

**Hold Time (Sec):** Waiting time to ping the target device for the duration of remote device boot

<input checked="" type="checkbox"/> Relay 1	
Event Type	Ping Failure
IP Address	192.168.2.100
Reset Time(Sec)	5
Hold Time(Sec)	50

How to configure: After selecting Ping Failure event type, the system will turn Relay Output to short state and continuously ping the target device. When the ping failure occurred, the switch will turn the Relay Output to open state for a period of Reset Time.

After the Reset Time timeout, the system will turn the Relay Output to close state. After the Hold Time timer is timeout, the switch system will start ping the target device.

Ex: Reset Time is 5 sec, Hold Time is 50 sec.

If the ping failure occurred, the switch system will turn Relay output to open state to emulate power switch off for 5 sec periods. After Reset Time timeout, the Switch system will start ping target device after 50 sec periods. The period time is for target device system booting. During the period, the switch system will

not ping target device until Hold Time is timeout.

Event Type: **Super Ring Failure**

Select Super Ring Failure. When the Rapid Super Ring topology is changed, the system will short Relay Out and lengthen Alarm LED.

The screenshot shows a configuration window for 'Relay 1'. At the top, there is a checked checkbox labeled 'Relay 1'. Below it, there is a section for 'Event Type' with a dropdown menu currently displaying 'Super Ring Failure'. The rest of the window is empty.

Once you finish configuring the settings, click on **Apply** to apply your configuration.

#### 4.12.2 Event Selection

Event Types can be divided into two basic groups: System Events and Port Events. System Events are related to the overall function of the switch, whereas Port Events related to the activity of specific ports

<b>System Event</b>	<b>Warning Event is sent when....</b>
Device Cold Start	Power is cut off and then reconnected.
Device Warm Start	Reboot the device by CLI or Web UI.
Authentication failure	An incorrect password, SNMP Community String is entered.
Time Synchronize Failure	Accessing to NTP Server is failure.
Fault Relay	The DO/Fault Relay is on.
Super Ring Topology Changes	Master of Super Ring has changed or backup path is activated.
SFP DDM Failure	The readed information of DDM SFP transceiver is over temperature or out the range of TX/RX power.
Power Failure	<b>Power (AC, DC1, DC2 or Any) is failure.</b>
<b>Port Event</b>	<b>Warning Event is sent when....</b>
Link-Up	The port is connected to another device
Link-Down	The port is disconnected (e.g. the cable is pulled out, or the opposing devices turns

	down)
Both	The link status changed.
<b>PoE Powering Event</b>	<b>Warning Event is sent when....</b>
Enable	The PoE port is powering.
Disable	The PoE port is not powering.

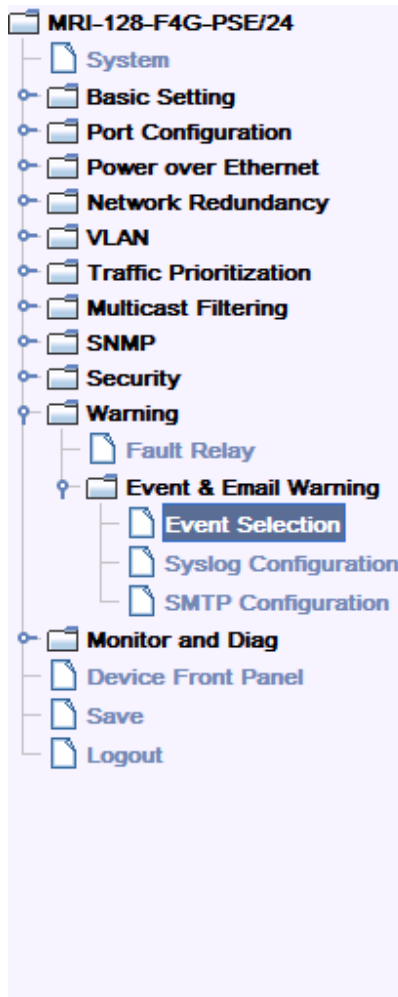

## Warning - Event Selection

### System Event Selection

- Device Cold Start       Device Warm Start  
 Authentication Failure       Time Synchronize Failure  
 Fault Relay       Super Ring Topology Change  
 SFP DDM Failure  
**Power Failure:**     AC     DC1     DC2

### Port Event Selection

Port	Link State
1	Disable
2	Disable
3	Disable
4	Disable
5	Disable
6	Disable
7	Disable
8	Disable
9	Disable
10	Disable

### PoE Event Selection

Port	PoE Powering Ev...
1	Disable
2	Disable
3	Disable
4	Disable
5	Disable
6	Disable
7	Disable
8	Disable
9	Disable
10	Disable

Once you finish configuring the settings, click on **Apply** to apply your configuration.

### 4.12.3 SysLog Configuration

System Log is useful to provide system administrator locally or remotely monitor switch events history. There are two System Log modes provided by the switch, local mode and remote mode.

**Local Mode:** In this mode, the switch will print the occurred events selected in the Event Selection page to System Log table of the switch. You can monitor the system logs in [Monitor and Diag] / [Event Log] page.

**Remote Mode:** In this mode, you should assign the IP address of the System Log server. The switch will send the occurred events selected in Event Selection page to System Log server you assigned.

**Both:** Both modes can be enabled at the same time.

**Warning - SysLog configuration**

Syslog Mode: Disable

Remote IP Address: [Field]

Note: When enabled Local or Remote for the system logs in the [Monitor and Diag][Event Log] page.

Apply

Once you finish configuring the settings, click on **Apply** to apply your configuration.

**Note:** When enabling Local or Both modes, you can monitor the system logs in [Monitor and Diag] / [Event Log] page.

#### 4.12.4 SMTP Configuration

The switch supports E-mail Warning feature. The switch will send the occurred events to remote E-mail server. The receiver can then receive notification by E-mail. The E-mail warning is conformed to SMTP standard.

This page allows you to enable E-mail Alert, assign the SMTP Server IP, Sender E-mail, and Receiver E-mail. If SMTP server requests you to authorize first, you can also set up the username and password in this page.

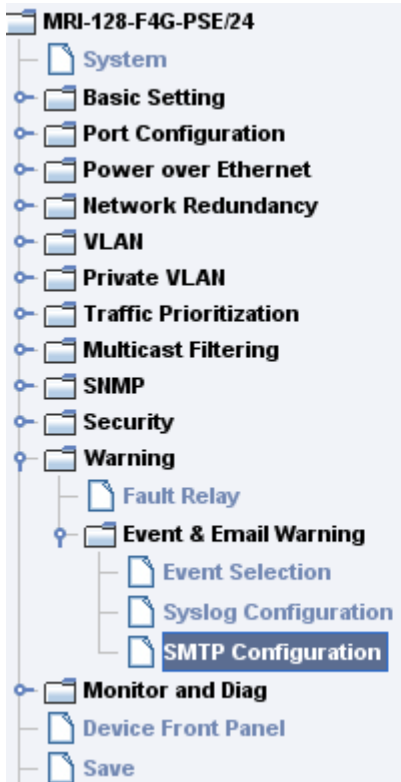

## Warning - SMTP Configuration

E-mail Alert

Disable ▼

### SMTP Configuration

SMTP Server IP	192.168.0.1
Mail Account	user@192.168.0.1
<input type="checkbox"/> Authentication	
User Name	
Password	
Confirm Password	
Rcpt E-mail Address 1	
Rcpt E-mail Address 2	
Rcpt E-mail Address 3	
Rcpt E-mail Address 4	

Apply

Field	Description
SMTP Server IP Address	Enter the IP address of the email Server
Authentication	Click on check box to enable password
User Name	Enter email Account name (Max.40 characters)
Password	Enter the password of the email account
Confirm Password	Re-type the password of the email account
You can set up to 4 email addresses to receive email alarm from switch	
Rcpt E-mail Address 1	The first email address to receive email alert from switch (Max. 40 characters)
Rcpt E-mail Address 2	The second email address to receive email alert from switch (Max. 40 characters)
Rcpt E-mail Address 3	The third email address to receive email alert from switch (Max. 40 characters)
Rcpt E-mail Address 4	The fourth email address to receive email alert from switch (Max. 40 characters)

Once you finish configuring the settings, click on **Apply** to apply your configuration.

#### 4.12.5 CLI Commands

## Command Lines of the Warning configuration

Feature	Command Line
<b>Relay Output</b>	
Relay Output	<pre>Switch(config)# relay 1 dry    dry output ping   ping failure port   port link failure power  power failure ring   super ring failure</pre>
Dry Output	<pre>Switch(config)# relay 1 dry &lt;0-4294967295&gt; turn on period in second Switch(config)# relay 1 dry 5 &lt;0-4294967295&gt; turn off period in second Switch(config)# relay 1 dry 5 5</pre>
Ping Failure	<pre>Switch(config)# relay 1 ping 192.168.2.200 &lt;cr&gt; reset  reset a device Switch(config)# relay 1 ping 192.168.2.200 reset &lt;1-65535&gt; reset time Switch(config)# relay 1 ping 192.168.2.200 reset 60 &lt;0-65535&gt; hold time to retry Switch(config)# relay 1 ping 192.168.2.200 reset 60 60</pre>
Port Link Failure	<pre>Switch(config)# relay 1 port PORTLIST port list Switch(config)# relay 1 port fal-5</pre>
Power Failure	<pre>Switch(config)# relay 1 power &lt;1-3&gt; power id (1: AC, 2: DC1, 3:DC2) any    Anyone power failure asserts relay Switch(config)# relay 1 power 1 Switch(config)# relay 1 power 2</pre>
Super Ring Failure	<pre>Switch(config)# relay 1 ring</pre>
Disable Relay	<pre>R. Switch(config)# no rell relay id Switch(config)# no relay 1 (Relay_ID: 1 or 2) &lt;cr&gt;</pre>
Display	<pre>Switch# show relay 1</pre>

	Relay Output Type : Port Link Port : 1, 2, 3, 4, 5,
<b>Event Selection</b>	
Event Selection	Switch(config)# warning-event coldstart Switch cold start event warmstart Switch warm start event linkdown Switch link down event linkup Switch link up event authentication Authentication failure event fault-relay Switch fault relay event poe-powering Switch PoE powering or unpowering event power Switch power failure event sfp-ddm Switch SFP DDM abnormal event super-ring Switch super ring topology change event time-sync Switch time synchronize event
Ex: Cold Start event	Switch(config)# warning-event coldstart Set cold start event enable ok.
Ex: Link Up event	Switch(config)# warning-event linkup [IFNAME] Interface list, ex: fa1,fa3-5,gi25-26 Switch(config)# warning-event linkup fa5 Set fa5 link up event enable ok.
Display	Switch# show warning-event Warning Event: Cold Start: Enabled Warm Start: Disabled Authentication Failure: Disabled Link Down: fa4-5 Link Up: fa4-5 Power Failure: Super Ring Topology Change: Disabled Fault Relay: Disabled Time synchronize Failure: Disable PoE Powering: SFP DDM: Enabled

<b>Syslog Configuration</b>	
Local Mode	Switch(config)# log syslog local
Server Mode	Switch(config)# log syslog remote 192.168.2.200
Both	Switch(config)# log syslog local Switch(config)# log syslog remote 192.168.2.200
Disable	Switch(config)# no log syslog local
<b>SMTP Configuration</b>	
SMTP Enable	Switch(config)# smtp-server enable email-alert SMTP Email Alert set enable ok.
Sender mail	Switch(config)# smtp-server server 192.168.2.200 ACCOUNT SMTP server mail account, ex: support@westermo.se Switch(config)# smtp-server server 192.168.2.200 support@westermo.se SMTP Email Alert set Server: 192.168.2.200, Account: support@westermo.se ok.
Receiver mail	Switch(config)# smtp-server receipt 1 support@westermo.se SMTP Email Alert set receipt 1: support@westermo.se ok.
Authentication with username and password	Switch(config)# smtp-server authentication username admin password admin SMTP Email Alert set authentication Username: admin, Password: admin  <b>Note: You can assign string to username and password.</b>
Disable SMTP	Switch(config)# no smtp-server enable email-alert SMTP Email Alert set disable ok.
Disable Authentication	Switch(config)# no smtp-server authentication SMTP Email Alert set Authentication disable ok.
Display	Switch# sh smtp-server SMTP Email Alert is Enabled Server: 192.168.2.200, Account: support@westermo.se Authentication: Enabled

	Username: admin, Password: admin SMTP Email Alert Receipt: Receipt 1: support@westermo.se Receipt 2: Receipt 3: Receipt 4:
--	---

## 4.13 Monitor and Diag

The switch provides several types of features for you to monitor the status of the switch or diagnostic for you to check the problem when encountering problems related to the switch. The features include MAC Address Table, Port Statistics, Port Mirror, Event Log and Ping.

Following commands are included in this section:

### 4.13.1 MAC Address Table

### 4.13.2 Port Statistics

### 4.13.3 Port Mirror

### 4.13.4 Event Log

### 4.13.5 Topology Discovery

### 4.13.6 Ping

### 4.13.7 CLI Commands of the Monitor and Diag

#### 4.13.1 MAC Address Table

The switch provides 16K entries in MAC Address Table. In this page, users can change the Aging time, add Static Unicast MAC Address, monitor the MAC address or sort them by different packet types and ports. Click on **Apply** to change the value.

#### **Aging Time (Sec)**

Each switch fabric has limit size to write the learned MAC address. To save more entries for new MAC address, the switch fabric will age out non-used MAC address entry per Aging Time timeout. The default Aging Time is 300 seconds. The Aging Time can be modified in this page.

#### **Static Unicast MAC Address**

In some applications, users may need to type in the static Unicast MAC address to its MAC address table. In this page, you can type MAC Address (format: xxx.xxxx.xxxx), select its VID and Port ID, and then click on **Add** to add it to MAC Address table.

#### **MAC Address Table**

In this MAC Address Table, you can see all the MAC Addresses learnt by the switch fabric. The packet types include Management Unicast, Static Unicast, Dynamic Unicast, Static Multicast and Dynamic Multicast. The table allows users to sort the address by the packet types and port.

**Packet Types: Management Unicast** means MAC address of the switch. It

belongs to CPU port only. **Static Unicast** MAC address can be added and deleted. **Dynamic Unicast** MAC is MAC address learnt by the switch Fabric. **Static Multicast** can be added by CLI and can be deleted by Web and CLI. **Dynamic Multicast** will appear after you enabled IGMP and the switch learnt IGMP report. Click on **Remove** to remove the static Unicast/Multicast MAC address. Click on **Reload** to refresh the table. New learnt Unicast/Multicast MAC address will be updated to MAC address table.

**MAC Address Table**

Aging Time (secs)

Apply

**Static Unicast MAC Address**

MAC Address	VID	Port
<input type="text"/>	<input type="text"/>	Port 1

Add

**MAC Address Table** All

MAC Address	Address Type	VID	1	2	3	4	5	6	7	8	9	10	11	12	13	14
001c.f0d1.b591	Dynamic Unicast	1	<input type="checkbox"/>	<input checked="" type="checkbox"/>	<input type="checkbox"/>	<input type="checkbox"/>	<input type="checkbox"/>	<input type="checkbox"/>	<input type="checkbox"/>	<input type="checkbox"/>	<input type="checkbox"/>	<input type="checkbox"/>	<input type="checkbox"/>	<input type="checkbox"/>	<input type="checkbox"/>	<input type="checkbox"/>

Remove Reload

#### 4.13.2 Port Statistics

In this page, you can view operation statistics for each port. The statistics that can be viewed include Link Type, Link State, Rx Good, Rx Bad, Rx Abort, Tx Good, Tx Bad and Collision. Rx means the received packet while Tx means the transmitted packets.

*Note: If you see many Bad, Abort or Collision counts increased, that may mean your network cable is not connected well, the network performance of the port is poor...etc. Please check your network cable, Network Interface Card of the connected device, the network application, or reallocate the network traffic...etc.*

Click on **Clear Selected** to reinitialize the counts of the selected ports, and **Clear All** to reinitialize the counts of all ports. Click on **Reload** to refresh the counts.

## Port Statistics

Port	Type	Link	State	Rx Good	Rx Bad	Rx Abort	Tx Good	Tx Bad	Collision
1	100BASE-TX	Down	Enable	0	0	0	0	0	0
2	100BASE-TX	Down	Enable	0	0	0	0	0	0
3	100BASE-TX	Down	Enable	33695467	1	166	30149795	0	0
4	100BASE-TX	Down	Enable	0	0	0	0	0	0
5	100BASE-TX	Down	Enable	0	0	0	0	0	0
6	100BASE-TX	Down	Enable	0	0	0	0	0	0
7	100BASE-TX	Up	Enable	4816	0	0	46880680	0	0
8	1000BASE	Down	Enable	0	0	0	0	0	0
9	1000BASE-LX	Up	Enable	30154992	0	256	33715385	0	0
10	1000BASE-LX	Up	Enable	3289	0	212	3078	0	0

### 4.13.3 Port Mirroring

Port mirroring (also called port spanning) is a tool that allows you to mirror the traffic from one or more ports onto another port, without disrupting the flow of traffic on the original port. Any traffic that goes in or out of the Source Port(s) will be duplicated at the Destination Port. This traffic can then be analyzed on the Destination port using a monitoring device or application. A network administrator will typically utilize this tool for diagnostics, debugging, or fending off attacks.

**Port Mirror Mode:** Select Enable/Disable to enable/disable Port Mirror.

**Source Port:** This is also known as Monitor Port. These are the ports you want to monitor and the traffic of all source/monitor ports will be copied to destination/analysis ports. You can choose a single port, or any combination of ports, but you can only monitor them in Rx or TX only. Click on checkbox of the Port ID, RX, Tx or Both to select the source ports.

**Destination Port:** This is also known as Analysis Port. You can analyze the traffic of all the monitored ports at this port without affecting the flow of traffic on the port(s) being monitored. Only one RX/TX of the destination port can be selected. A network administrator would typically connect a LAN analyzer to this port. Once you finish configuring the settings, click on **Apply** to apply the settings.



## Port Mirroring

Port Mirror Mode

### Port Selection

Port	Source Port		Destination Port
	Rx	Tx	
1	<input checked="" type="checkbox"/>	<input checked="" type="checkbox"/>	<input type="radio"/>
2	<input type="checkbox"/>	<input type="checkbox"/>	<input checked="" type="radio"/>
3	<input type="checkbox"/>	<input type="checkbox"/>	<input type="radio"/>
4	<input type="checkbox"/>	<input type="checkbox"/>	<input type="radio"/>
5	<input type="checkbox"/>	<input type="checkbox"/>	<input type="radio"/>
6	<input type="checkbox"/>	<input type="checkbox"/>	<input type="radio"/>
7	<input type="checkbox"/>	<input type="checkbox"/>	<input type="radio"/>
8	<input type="checkbox"/>	<input type="checkbox"/>	<input type="radio"/>
9	<input type="checkbox"/>	<input type="checkbox"/>	<input type="radio"/>
10	<input type="checkbox"/>	<input type="checkbox"/>	<input type="radio"/>

### 4.13.4 Event Log

When System Log Local mode is selected, The switch will record occurred events in local log table. This page shows this log table. The entry includes the index, occurred data and time and content of the events.

Click on **Clear** to clear the entries. Click on **Reload** to refresh the table.

## System Event Logs

Index	Date	Time	Event Log
1	Jan 1	02:47:37	Event Link 1 Up.
2	Jan 1	02:47:35	Event Link 2 Up.
3	Jan 1	02:47:35	Event Link 1 Down.

#### 4.13.5 Topology Discovery

The switch supports 802.1AB Link Layer Discovery Protocol, thus the 5428G can be discovered by the Network Management System which support LLDP discovery. With LLDP supported, the NMS can easier maintain the topology map, display port ID, port description, system description, VLAN ID... Once the link failure, the topology change events can be updated to the NMS as well. The LLDP Port State can display the neighbor ID and IP learnt from the connected devices.

**Topology Discovery**

LLDP

**LLDP Configuration**

LLDP timer	30
LLDP hold time	120

**LLDP Port State**

Local Port	Neighbor ID	Neighbor IP	Neighbor VID

**LLDP:** Select Enable/Disable to enable/disable LLDP function.

**LLDP Configuration:** To configure the related timer of LLDP.

**LLDP Timer:** The interval time of each LLDP and counts in second; the valid number is from 5 to 254, default is 30 seconds.

**LLDP Hold time:** The TTL (Time to Live) timer. The LLDP state will be expired once the LLDP is not received by the hold time. The default is 120 seconds.

**Local port:** the current port number that linked with neighbor network device.

**Neighbor ID:** The MAC address of neighbor device on the same network segment.

**Neighbor IP:** The IP address of neighbor device on the same network segment.

**Neighbor VID:** The VLAN ID of neighbor device on the same network segment.

#### 4.13.6 Ping Utility

This page provides **Ping Utility** for users to ping remote device and check whether the device is alive or not. Type **Target IP** address of the target device and click on **Start** to start the ping. After few seconds, you can see the result in the **Result** field.

### Ping Utility

#### Ping

Target IP

#### Result

```
64 bytes from 192.168.2.110: icmp_seq=0 ttl=64 time=10.0 ms
64 bytes from 192.168.2.110: icmp_seq=1 ttl=64 time=0.0 ms
64 bytes from 192.168.2.110: icmp_seq=2 ttl=64 time=0.0 ms
64 bytes from 192.168.2.110: icmp_seq=3 ttl=64 time=0.0 ms
64 bytes from 192.168.2.110: icmp_seq=4 ttl=64 time=0.0 ms

--- 192.168.2.110 ping statistics ---
5 packets transmitted, 5 packets received, 0% packet loss
round-trip min/avg/max = 0.0/2.0/10.0 ms
```

#### 4.13.7 CLI Commands of the Monitor and Diag

Command Lines of the Monitor and Diag configuration

Feature	Command Line
<b>MAC Address Table</b>	
Ageing Time	Switch(config)# mac-address-table aging-time 350 mac-address-table aging-time set ok!  <i>Note: 350 is the new ageing timeout value.</i>
Add Static Unicast MAC address	Switch(config)# mac-address-table static 0007.7c01.0101 vlan 1 interface fastethernet7 mac-address-table ucast static set ok!

	<p><b>Note: rule: mac-address-table static</b></p> <p><b>MAC_address VLAN VID interface interface_name</b></p>																																							
Add Multicast MAC address	<pre>Switch(config)# mac-address-table multicast 0100.5e01.0101 vlan 1 interface fa6-7</pre> <p>Adds an entry in the multicast table ok!</p> <p><b>Note: rule: mac-address-table multicast</b></p> <p><b>MAC_address VLAN VID interface_list interface_name/range</b></p>																																							
Show MAC Address Table - All types	<pre>Switch# show mac-address-table</pre> <p>***** UNICAST MAC ADDRESS *****</p> <table border="1"> <thead> <tr> <th>Destination Address</th> <th>Address Type</th> <th>Vlan</th> <th>Destination Port</th> </tr> </thead> <tbody> <tr> <td>000f.b079.ca3b</td> <td>Dynamic</td> <td>1</td> <td>fa4</td> </tr> <tr> <td>0007.7c01.0386</td> <td>Dynamic</td> <td>1</td> <td>fa7</td> </tr> <tr> <td>0007.7c10.0101</td> <td>Static</td> <td>1</td> <td>fa7</td> </tr> <tr> <td>0007.7c10.0102</td> <td>Static</td> <td>1</td> <td>fa7</td> </tr> <tr> <td>0007.7cff.0100</td> <td>Management</td> <td>1</td> <td></td> </tr> </tbody> </table> <p>***** MULTICAST MAC ADDRESS *****</p> <table border="1"> <thead> <tr> <th>Vlan</th> <th>Mac Address</th> <th>COS</th> <th>Status</th> <th>Ports</th> </tr> </thead> <tbody> <tr> <td>1</td> <td>0100.5e40.0800</td> <td>0</td> <td>fa6</td> <td></td> </tr> <tr> <td>1</td> <td>0100.5e7f.ffff</td> <td>0</td> <td>fa4,fa6</td> <td></td> </tr> </tbody> </table>	Destination Address	Address Type	Vlan	Destination Port	000f.b079.ca3b	Dynamic	1	fa4	0007.7c01.0386	Dynamic	1	fa7	0007.7c10.0101	Static	1	fa7	0007.7c10.0102	Static	1	fa7	0007.7cff.0100	Management	1		Vlan	Mac Address	COS	Status	Ports	1	0100.5e40.0800	0	fa6		1	0100.5e7f.ffff	0	fa4,fa6	
Destination Address	Address Type	Vlan	Destination Port																																					
000f.b079.ca3b	Dynamic	1	fa4																																					
0007.7c01.0386	Dynamic	1	fa7																																					
0007.7c10.0101	Static	1	fa7																																					
0007.7c10.0102	Static	1	fa7																																					
0007.7cff.0100	Management	1																																						
Vlan	Mac Address	COS	Status	Ports																																				
1	0100.5e40.0800	0	fa6																																					
1	0100.5e7f.ffff	0	fa4,fa6																																					
Show MAC Address Table - Dynamic Learnt MAC addresses	<pre>Switch# show mac-address-table dynamic</pre> <table border="1"> <thead> <tr> <th>Destination Address</th> <th>Address Type</th> <th>Vlan</th> <th>Destination Port</th> </tr> </thead> <tbody> <tr> <td>000f.b079.ca3b</td> <td>Dynamic</td> <td>1</td> <td>fa4</td> </tr> <tr> <td>0007.7c01.0386</td> <td>Dynamic</td> <td>1</td> <td>fa7</td> </tr> </tbody> </table>	Destination Address	Address Type	Vlan	Destination Port	000f.b079.ca3b	Dynamic	1	fa4	0007.7c01.0386	Dynamic	1	fa7																											
Destination Address	Address Type	Vlan	Destination Port																																					
000f.b079.ca3b	Dynamic	1	fa4																																					
0007.7c01.0386	Dynamic	1	fa7																																					
Show MAC Address Table - Multicast MAC addresses	<pre>Switch# show mac-address-table multicast</pre> <table border="1"> <thead> <tr> <th>Vlan</th> <th>Mac Address</th> <th>COS</th> <th>Status</th> <th>Ports</th> </tr> </thead> <tbody> <tr> <td>1</td> <td>0100.5e40.0800</td> <td>0</td> <td>fa6</td> <td></td> </tr> <tr> <td>1</td> <td>0100.5e7f.ffff</td> <td>0</td> <td>fa4,fa6</td> <td></td> </tr> </tbody> </table>	Vlan	Mac Address	COS	Status	Ports	1	0100.5e40.0800	0	fa6		1	0100.5e7f.ffff	0	fa4,fa6																									
Vlan	Mac Address	COS	Status	Ports																																				
1	0100.5e40.0800	0	fa6																																					
1	0100.5e7f.ffff	0	fa4,fa6																																					

	<pre> ----- 1  0100.5e40.0800    0  fa6-7 1  0100.5e7f.ffff    0  fa4,fa6-7 </pre>
Show MAC Address Table - Static MAC addresses	<pre> Switch# show mac-address-table static Destination Address  Address Type      Vlan Destination Port ----- ----- 0007.7c10.0101      Static           1      fa7 0007.7c10.0102      Static           1      fa7 </pre>
Show Aging timeout time	<pre> Switch# show mac-address-table aging-time the mac-address-table aging-time is 300 sec. </pre>
<b>Port Statistics</b>	
Port Statistics	<pre> Switch# show rmon statistics fa4 (select interface) Interface fastethernet4 is enable connected, which has Inbound:   Good Octets: 178792, Bad Octets: 0   Unicast: 598, Broadcast: 1764, Multicast: 160   Pause: 0, Undersize: 0, Fragments: 0   Oversize: 0, Jabbers: 0, Disacrcs: 0   Filtered: 0, RxError: 0, FCSError: 0 Outbound:   Good Octets: 330500   Unicast: 602, Broadcast: 1, Multicast: 2261   Pause: 0, Deferred: 0, Collisions: 0   SingleCollision: 0, MultipleCollision: 0   ExcessiveCollision: 0, LateCollision: 0   Filtered: 0, FCSError: 0 Number of frames received and transmitted with a length of:   64: 2388, 65to127: 142, 128to255: 11   256to511: 64, 512to1023: 10, 1024toMaxSize: 42 </pre>
<b>Port Mirroring</b>	
Enable Port Mirror	<pre> Switch(config)# mirror en Mirror set enable ok. </pre>

Disable Port Mirror	Switch(config)# mirror disable Mirror set disable ok.
Select Source Port	Switch(config)# mirror source fa1-2 both Received and transmitted traffic rx Received traffic tx Transmitted traffic Switch(config)# mirror source fa1-2 both Mirror source fa1-2 both set ok.  <b>Note: Select source port list and TX/RX/Both mode.</b>
Select Destination Port	Switch(config)# mirror destination fa6 Mirror destination fa6 set ok
Display	Switch# show mirror Mirror Status : Enabled Ingress Monitor Destination Port: fa6 Egress Monitor Destination Port: fa6 Ingress Source Ports :fa1,fa2, Egress Source Ports :fa1,fa2,
<b>Event Log</b>	
Display	Switch# show event-log <1>Jan 1 02:50:47 snmpd[101]: Event: Link 4 Down. <2>Jan 1 02:50:50 snmpd[101]: Event: Link 5 Up. <3>Jan 1 02:50:51 snmpd[101]: Event: Link 5 Down. <4>Jan 1 02:50:53 snmpd[101]: Event: Link 4 Up.
<b>Ping</b>	
Ping IP	Switch# ping 192.168.2.33 PING 192.168.10.33 (192.168.2.33): 56 data bytes 64 bytes from 192.168.2.33: icmp_seq=0 ttl=128 time=0.0 ms 64 bytes from 192.168.2.33: icmp_seq=1 ttl=128 time=0.0 ms 64 bytes from 192.168.2.33: icmp_seq=2 ttl=128 time=0.0 ms 64 bytes from 192.168.2.33: icmp_seq=3 ttl=128 time=0.0 ms

```
64 bytes from 192.168.2.33: icmp_seq=4 ttl=128
time=0.0 ms

--- 192.168.2.33 ping statistics ---
 5 packets transmitted, 5 packets received, 0%
  packet loss
round-trip min/avg/max = 0.0/0.0/0.0 ms
```

## 4.14 Device Front Panel

Device Front Panel allows you to see LED status on the switch. You can see LED and link status of the Power, Alarm, R.S. and Ports.

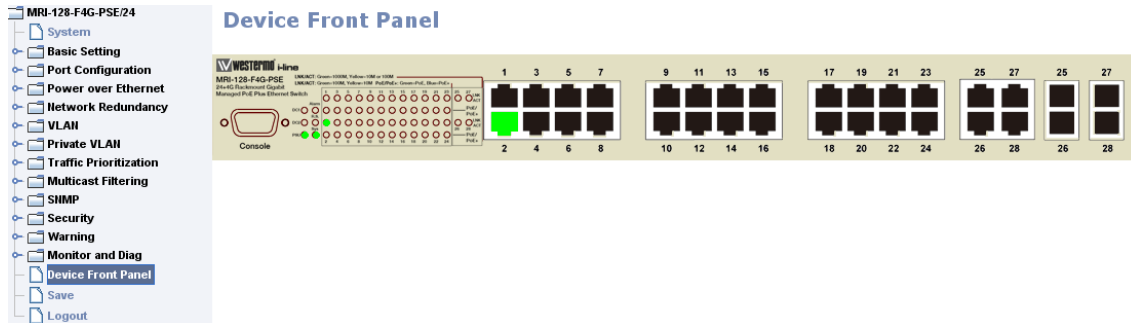

Feature	On / Link UP	Off / Link Down	Other
PSU	Green	Black	
DC1	Green	Black	
DC2	Green	Black	
Sys	Green	Black	
R.S.	Green: Ring state is normal Amber: Ring state is abnormal	Black	Green Flashing: Incorrect configuration Amber Flashing: One of the ring ports break has been detected
Alarm	Red	Black	

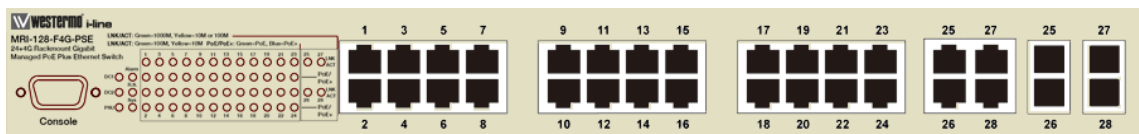

### MRI-128-F4G-PSE/24

**Note:** No CLI command for this feature.

## 4.15 Save to Flash

**Save Configuration** allows you to save any configuration you just made to the Flash. Powering off the switch without clicking on **Save Configuration** will cause loss of the new settings. After selecting **Save Configuration**, click on **Save to Flash** to save your new configuration.

### Command Lines:

Feature	Command Line
Save	SWITCH# write Building Configuration... [OK]  Switch# copy running-config startup-config Building Configuration... [OK]

## 4.16 Logout

The switch provides two logout methods. The web connection will be logged out if you don't input any command after 30 seconds. The Logout command allows you to manually logout the web connection. Click on **Yes** to logout, **No** to go back the configuration page.

### Command Lines:

Feature	Command Line
Logout	SWITCH> exit  SWITCH# exit

# 5 Appendix

## 5.1 Pin Assignment of the RS-232 Console Cable

The total cable length is 150cm.

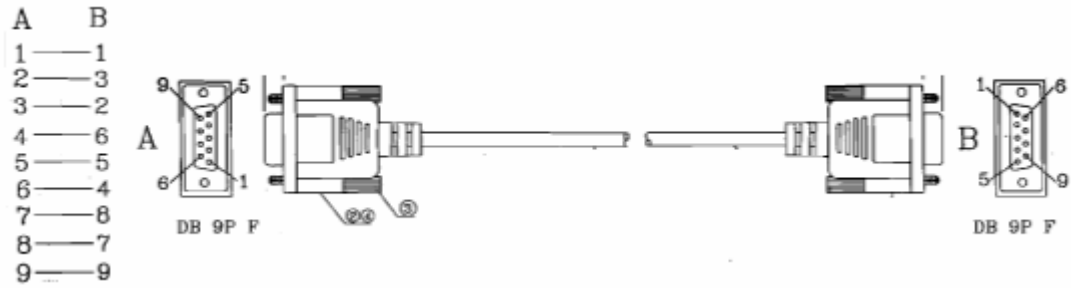

## 5.2 Private MIB

The private MIB can be found in product CD. Compile the private MIB file by your SNMP tool. The private MIB tree is the same as the web tree. This is easier to understand and use. If you are not familiar with standard MIB, you can directly use private MIB to manage/monitor the switch, no need to learn or find where the OIDs of the commands are.

### 5.3 Revision History

Edition	Date	Modifications
V1.0	2010/11/30	The first release
V1.1	2013/11/14	Add IPv6, MSTP, QinQ and private VLAN features Delete the MRI-120-F4G-PSE/8 & MRI-128-F4G-PSE/16



Westermo • SE-640 40 Stora Sundby, Sweden  
Tel +46 16 42 80 00 Fax +46 16 42 80 01  
E-mail: [info@westermo.com](mailto:info@westermo.com)  
[www.westermo.com](http://www.westermo.com)

## Sales Units

### Westermo Data Communications

---

**China**  
[sales.cn@westermo.com](mailto:sales.cn@westermo.com)  
[www.cn.westermo.com](http://www.cn.westermo.com)

**France**  
[infos@westermo.fr](mailto:infos@westermo.fr)  
[www.westermo.fr](http://www.westermo.fr)

**Germany**  
[info@westermo.de](mailto:info@westermo.de)  
[www.westermo.de](http://www.westermo.de)

**North America**  
[info@westermo.com](mailto:info@westermo.com)  
[www.westermo.com](http://www.westermo.com)

**Singapore**  
[sales@westermo.com.sg](mailto:sales@westermo.com.sg)  
[www.westermo.com](http://www.westermo.com)

**Sweden**  
[info.sverige@westermo.se](mailto:info.sverige@westermo.se)  
[www.westermo.se](http://www.westermo.se)

**United Kingdom**  
[sales@westermo.co.uk](mailto:sales@westermo.co.uk)  
[www.westermo.co.uk](http://www.westermo.co.uk)

**Other Offices**



*For complete contact information, please visit our website at [www.westermo.com/contact](http://www.westermo.com/contact) or scan the QR code with your mobile phone.*