

Installationsanvisning
User Guide
Installation Anleitung
Manuel D'installation
6153-2004

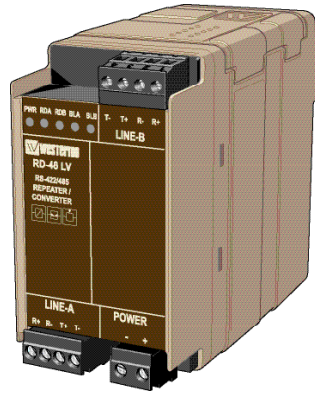

RD-48

H V / L V



RS-422/485 Repeater
Répéteur RS-422/485

www.westermo.com

Innehållsförteckning

1. Introduktion	3
2. Säkerhet	3
3. Godkännanden	3
3.1 Förenklad EU-försäkran om överensstämmelse	56
4. Specifikationer	4
4.1 Anslutningar	4
4.2 Isolation mellan gränssnitt	4
4.3 Klimatisk miljö	4
4.4 Mekaniska data	5
5. Underhåll	5
6. Installation	5 – 10
6.1 Montering/Demontering	5
6.2 Anslutningar	6
6.2.1 Matning (RD-48 HV)	7
6.2.2 Matning (RD-48 LV/RD-48 LV TEMP)	7
6.2.3 Linje A RS-422/485	7
6.2.3 Linje B RS-422/485	7
6.3 Statusindikering	7
6.3.1 Lysdioder	7
6.4 Switchinställningar	8 – 10
7. Funktionsbeskrivning	11 – 12
7.1 Driftsätt	11
7.2 Val av datahastighet och format	12
7.3 Inställning av retiming	12
7.4 Inställning av anti-blocking	12
7.5 Val av RS-422/485 struktur	12
8. Blockdiagram	13
9. Applikationsexempel	14

1. Introduktion

RD-48 är en industriell repeater för RS-422/485 system. Den kan också användas som omvandlare mellan 2- och 4-tråds system eller som isolator för att skydda t ex PLC-system från transienter och överspänningar.

RS-422/485 standard stöder 32 noder på en sträcka av 1200 meter. RD-48 ökar detta med ytterligare 31 noder och 1200 meter. RD-48 monteras på en standard 35 mm DIN skena.

2. Säkerhet



Allmänt:

Innan enheten används, läs denna manual fullständigt och jämför med uppgifter på enheten, samt säkerställ att du har förstått all information. Kontrollera att användandet av enheten i din installation inte kommer att överskrida specificerade säkerhetsprestanda för enheten.



Före installation, reparation, eller modifiering:

Potentialutjämna dig till en jordnings punkt (tex. genom att använda handledsband), så att skada av intern elektronik på grund av elektrostatiska urladdningar (ESD) förhindras.

Koppla ifrån enheten från AC/DC matningsnät samt alla andra elektriska anslutningar, så att åtkomst till farliga spänningar förhindras.



Installation:

Enheten är konstruerad för användning i professionella system. Enheten skall installeras i utrymmen med begränsad åtkomst, tex. låsbart skåp med tillräde endast för service personal.

Enheten är konstruerad för fast anslutning till AC/DC matningsnät och skall installeras av behörig personal.

Enhetens anslutning till matningsnätet skall vara tillräckligt avsäkrat, och om så krävs skall det vara möjligt att manuellt koppla från enheten från matningsnätet. Observera att nationella installations regler skall följas.

Enhet med märkspänning överskridande 42,4 V topp eller 60V DC, klassas som skyddsjordad (klass I) utrustning.

Enhet med märkspänning underskridande 42,4 V topp eller 60V DC, klassas som klass III utrustning och skall vara separerad från farlig spänning med dubbel eller förstärkt isolation.

Enheten kyls genom konvektion. Följ föreskrivna monterings rekommendationer för att förhindra störningar i kylande luftström kring enheten (se Installation).

3. Godkännanden

Uppfyllande av direktiv 2006/95/EC (lågspänningsdirektivet) har säkerställts genom tillämpning av standard EN 60950-1.

Uppfyllande av direktiv 2004/108/EC (elektromagnetisk kompatibilitet) har säkerställts genom tillämpning av standard EN61000-6-2 (immunitet) och standard EN61000-6-4 (emission från utrustning i industrimiljö).

4. Specifikationer

4.1 Anslutningar

Matningsanslutning

Modell	RD-48 LV	RD-48 LV TEMP	RD-48 HV
Märkspänning	12–48 VDC		95–240 VAC 110–250 VDC
Arbetsspänning	9,6–57,6 VDC		85,5–264 VAC 88–300 VDC
Märkström	300 mA		50 mA
Märkfrekvens	–		48–62 Hz
Polaritet	Polaritets skyddad		Polaritets oberoende
Anslutning	2-position skruvplint		3-position skruvplint
Anslutnings area	0,2 – 2,5 mm ² (AWG 24-12)		
Säkring	Säkras externt		

RS-422/485 gränssnitt – Linje A

Elektrisk specifikation	RS-422/485
Datahastighet	300 bit/s – 1,5 Mbit/s
Anslutning	4-polig skruvplint
Anslutningsarea	0,2 – 2,5 mm ² (AWG 24-12)
Kretstyp	TNV-1

RS-422/485 gränssnitt – Linje B

Elektrisk specifikation	RS-422/485
Datahastighet	300 bit/s – 1,5 Mbit/s
Anslutning	4-polig skruvplint
Anslutningsarea	0,2 – 2,5 mm ² (AWG 24-12)
Kretstyp	TNV-1

4.2 Isolation mellan gränssnitt

Matning (RD-48 HV) till alla andra	3,0 kV RMS @ 50 Hz och 60 s varaktighet
Matning (RD-48 LV) till alla andra	1,0 kV RMS @ 50 Hz och 60 s varaktighet
Linje-A till Linje-B	1,5 kV RMS @ 50 Hz och 60 s varaktighet

4.3 Klimatisk miljö

Temperatur, drift	5 till 55°C –40 till 70°C (TEMP version)
Temperatur, lagring och transport	–40 till 70°C
Relativ fuktighet, drift	5 till 95% (icke kondenserande)
Relativ fuktighet, lagring och transport	5 to 95% (kondensation på utsidan av förpackningen tillåten)

4.4 Mekaniska data

Dimension (B x H x D)	55 x 128 x 100 mm
Vikt	0,3 kg
Montering	35 mm DIN-skena
Kapsling	IP 20 (IEC 529)

5. Underhåll

Inget krav på underhåll, så länge enheten används på avsett sätt inom specificerade förutsättningar.

6. Installation

6.1 Montering/Demontering

Före montering eller demontering av enheten:

Potentialutjämna dig till en jordnings punkt (tex. genom att använda handledsband), så att skada av intern elektronik på grund av elektrostatiska urladdningar (ESD) förhindras.

Koppla ifrån enheten från AC/DC matningsnät samt alla andra elektriska anslutningar, så att återkomst till farliga spänningar förhindras.

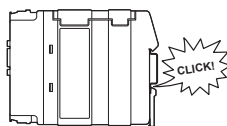
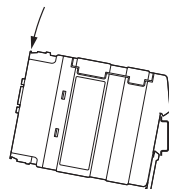

Montering

Enheten är avsedd att monteras på en 35 mm DIN skena vilken skall vara horisontellt festsatt, tex. på en vägg eller montageplåt i skåp.

Enheten kyls genom konvektion. För att förhindra störningar i kylande luftström kring enheten krävs ett fritt utrymme på

25 mm ovan/nedan och 10 mm till vänster/höger om enheten.

Snäppfastsättning utan verktyg, se figur.

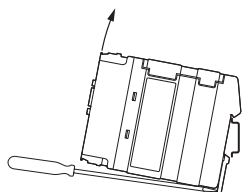
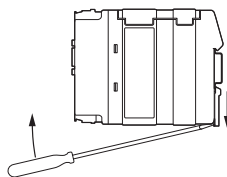
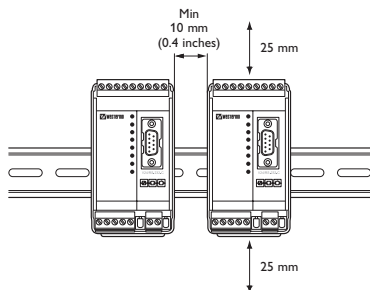

Demontering

Pressa ner den svarta hållaren på enhetens nedre del med hjälp av en skruvmejsel, se figur.

6.2 Anslutningar

Line B gränssnitt

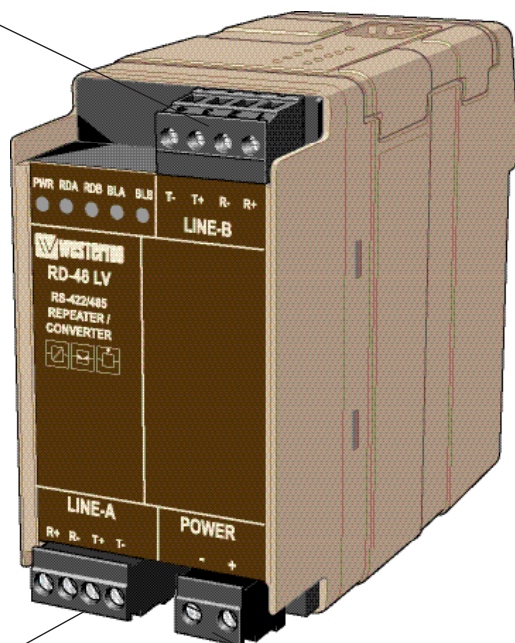

Line A gränssnitt

Matningsgränssnitt

6.2.1 Matning (RD-48 HV)



3-polig skruvplint	Beskrivning
L	Spänning AC fas / Spänning DC
N	Spänning AC nolla / Spänning DC
	Spänning AC skyddsjord

6.2.2 Matning (RD-48 LV / RD-48 LV TEMP)



2-polig skruvplint	Beskrivning
Nr. 1	Spänning DC –
Nr. 2	Spänning DC +

6.2.3 Linje A RS-422/485



4-polig skruvplint	Beskrivning	Beskrivning
Nr. 1	In	R+ RS-422 mottagare
Nr. 2	In	R– RS-422 mottagare
Nr. 3	In/Ut	T+ RS-422/485 sändare/mottagare
Nr. 4	In/Ut	T– RS-422/485 sändare/mottagare

6.2.4 Linje B RS-422/485



4-polig skruvplint	Beskrivning	Beskrivning
Nr. 1	In	R+ RS-422 mottagare
Nr. 2	In	R– RS-422 mottagare
Nr. 3	In/Ut	T+ RS-422/485 sändare/mottagare
Nr. 4	In/Ut	T– RS-422/485 sändare/mottagare

6.3 Statusindikering

6.3.1 Lysdioder

PWR	LED till LED från	Matningsspänning korrekt Ingen matningsspänning
RDA	LED till LED från	Mottagen data linje A Ingen data linje A
RDB	LED till LED från	Mottagen data linje B Ingen data linje B
BLA	LED till LED från	Blockering linje A Ingen blockering linje A
BLB	LED till LED från	Blockering linje B Ingen blockering linje B

6.4 Switchinställningar

DIP-switchar är tillgängliga under locket på toppen/fronten av repeatern. DIP-switcharna används för att konfigurera enheten.



Varning!

Potentialutjämna dig till en jordningspunkt (t ex genom att använda handledsband), så att skada av intern elektronik på grund av elektrostatiska urladdningar (ESD) förhindras, innan locket på modemets topp tas av.



Varning! Öppna ej ansluten enhet.

Koppla ifrån enheten från AC/DC matningsnät samt alla andra elektriska anslutningar, så att åtkomst till farliga spänningar förhindras.

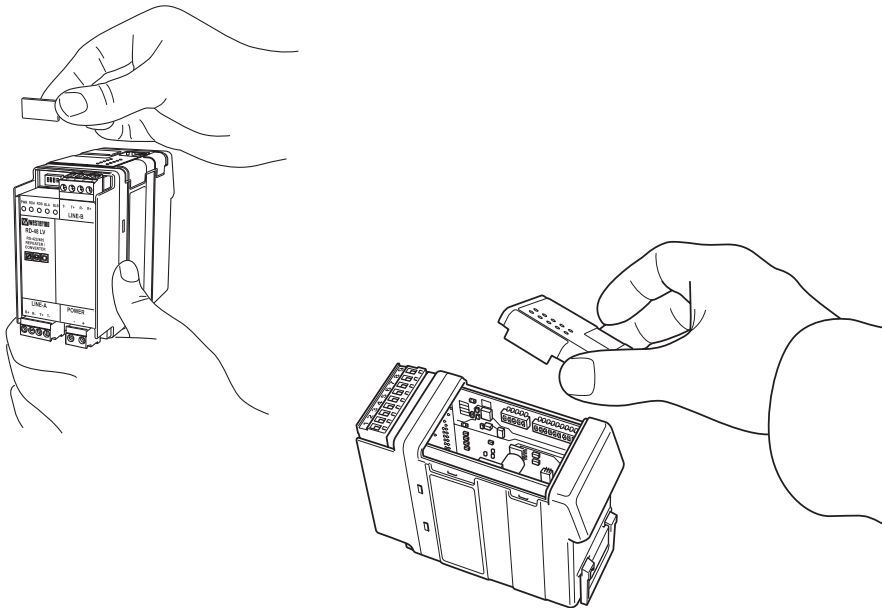

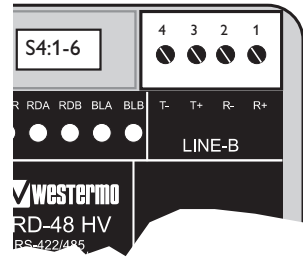
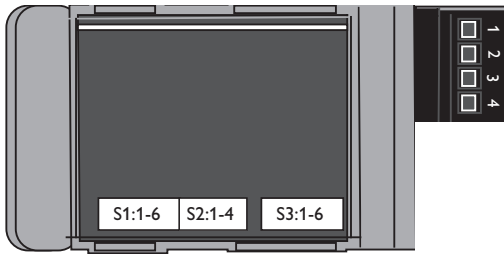

Switchblock 1 – S1

Hastighet



300 bit/s



57 600 bit/s



1 200 bit/s



93 750 bit/s



2 400 bit/s



115,2 kbit/s



4 800 bit/s



187,5 kbit/s



9 600 bit/s



375 kbit/s

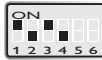

19 200 bit/s



500 kbit/s

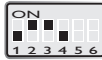

38 400 bit/s



1 500 kbit/s

Formatinställningar



9 bitar format



10 bitar format



11 bitar format



Synkront format

Vändtid 1–2 bitar vid samtliga hastigheter och format.

Switchblock 2 – S2

Funktionsläge



Retiming inaktiv



Retiming aktiv



Anti-blocking inaktiv



Anti-blocking aktiv

Linje A



4-tråd



2-tråd

Linje B



4-tråd



2-tråd

Switchblock 3 – S3

RS-422/485 inställning Linje-A



Inaktiv
fail-safe 4-tråd



Inaktiv
fail-safe 2-tråd

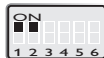

Aktiv
fail-safe 4-tråd



Aktiv
fail-safe 2-tråd



Ingen terminering
4-tråd



Ingen terminering
2-tråd



Terminering
4-tråd



Terminering
2-tråd

Switchblock 4 –S4

RS-422/485 inställning Linje-B



Inaktiv
fail-safe 4-tråd



Inaktiv
fail-safe 2-tråd



Aktiv
fail-safe 4-tråd



Aktiv
fail-safe 2-tråd



Ingen terminering
4-tråd



Ingen terminering
2-tråd



Terminering
4-tråd



Terminering
2-tråd

Fabriksinställning



S1 9 600 bit/s,
10 bitar format



S3 Ingen terminering,
inaktiv fail-safe



S2 Anti blocking aktiv,
Retiming inaktiv



S4 Ingen terminering,
inaktiv fail-safe

7. Funktionsbeskrivning

7.1 Driftsätt

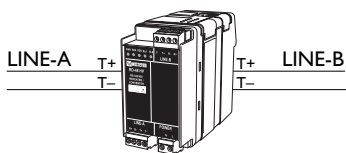

RS-485 repeater

Detta driftsätt används för att utöka antalet laster eller längden på en 2-tråds (RS-485) bus.

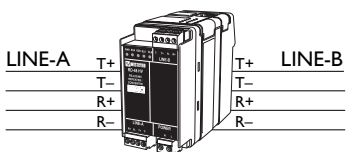

RS-422 repeater

Detta driftsätt används för att utöka antalet laster eller längden på en 4-tråds (RS-422) bus.

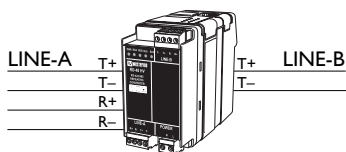

RS-422/485 converter

Detta driftsätt används för att omvandla 2-tråds (RS-485) till/från 4-tråds (RS-422) kommunikation.

OBS! R+/R-, T+/T- definitionerna är ej standardiserade.
Det kan hjälpa att skifta polaritet om enheten inte fungerar.

7.2 Val av datahastighet och format

Datahastighet och format används för att bestämma vändtiden på RS-422/485 bussen. För att optimera funktionen måste datahastighet och format ställas in enligt det använda protokollet.

Switcharna för datahastighet ställer in hastighet på både linje A och linje B.

Observera att RD-48 är en transparent enhet och att datahastigheten måste vara den samma på båda sidor av enheten.

Med formatswitcharna väljer man format på både linje A och linje B. 9-, 10- eller 11-bitars format används för asynkrona protokoll. Synkront format innebär att sändaren aktiveras i 11 bitar efter en detekterad data bit.

7.3 Inställning av retiming

Retiming är möjlig på de högre datahastigheterna (187,5 kbit/s och högre).

Retiming återskapar databitarna till rätt bitlängd beroende på inställd hastighet.

Användandet av retiming gör det möjligt att koppla in ett större antal RD-48 i serie.

7.4 Inställning av anti-blocking

Anti-blocking funktionen säkrar kommunikationen på båda sidor om RD-48 repeatern.

Om linjen är konstant aktiv (blockerad) i mer än 50 ms kommer anti-blocking funktionen att bryta förbindelsen på den sidan av repeatern. Detta gör det möjligt att kommunicera mellan enheter på andra sidan av repeatern. När linjen blir återställd kommer repeatern automatiskt att återuppta förbindelsen.

7.5 Val av RS-422/485 struktur

Ett standard RS-422/485 system skall alltid vara i form av en busstruktur. Om man använder RD-48 är det möjligt att konstruera stjärn nät. Det är viktigt att terminera RS-422/485 nät för att förhindra reflektioner och störningar i systemet, RD-48 är beroende av detta för en korrekt funktion.

I ett standardnätverk skall fail-safe funktionen också vara inkopplad. Fail-safe tvingar mot-tagaren till en definierad nivå då inkopplad sändare är inaktiv. Detta gör systemet mindre störcänsligt.

Vi rekommenderar inställning av terminering och fail-safe enligt applikationsexemplet.

8. Blockdiagram

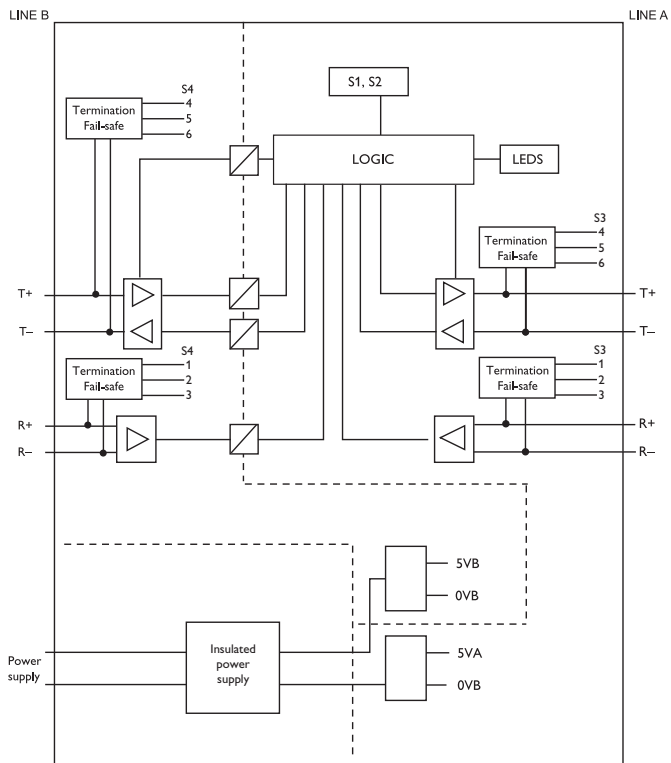

9. Applikationsexempel

En typisk applikation är om man behöver koppla nätet som ett stjärn nät. Detta tillåter normalt inte RS-422/485. Ansluter man en RD-48 repeater i varje grenkoppling (max 30 cm från bussen) kan förgreningarna förlängas ända upp till 1200 m.

Observera terminering och fail-safe-inställningarna i nätet.

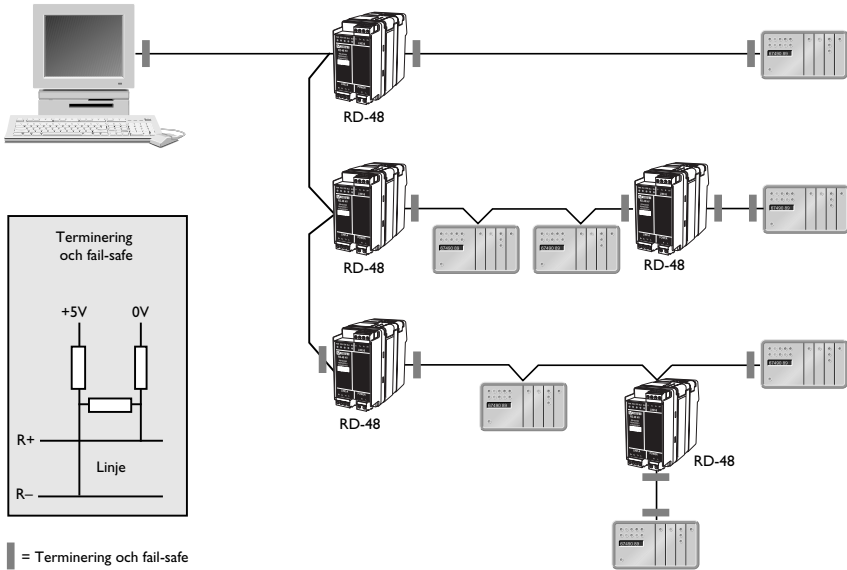

OBS! Maximalt 8 repeaters är möjligt att koppla i serie

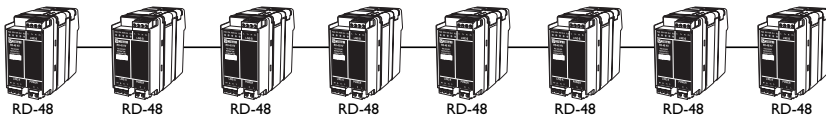

Contents

1. Introduction	16
2. Safety	16
3. Approvals	16
3.1 Simplified EU declaration of conformity	56
4. Specifications	17
4.1 Connections	17
4.2 Insulation between interfaces	17
4.3 Climatic environment	17
4.4 Mechanics	18
5. Maintenance	18
6. Installation	18 – 23
6.1 Mounting/Removal	18
6.2 Connections	19
6.2.1 Power (RD-48 HV)	20
6.2.2 Power (RD-48 LV/RD-48 LV TEMP)	20
6.2.3 Line A RS-422/485	20
6.2.4 Line B RS-422/485	20
6.3 Indicators	20
6.3.1 LED indicators	20
6.4 DIP switch settings	21 – 23
7. Functional description	24 – 25
7.1 Operating modes	24
7.2 Selection of data rate/format	25
7.3 Setting and retiming	25
7.4 Setting and anti-blocking	25
7.5 Selection of RS-422/485 setting	25
8. Block diagram	26
9. Application example	27

1. Introduction

The RD-48, is an industrial repeater for RS-422/485 buses. It can also be used as an converter between 2- and 4-wire systems or as an isolator to protect for example a PLC from transients or overvoltage.

The standard RS-422/485 bus supports 32 nodes at a distance of 1200 meters.

The RD-48 gives you another 31 nodes and further max.1200 meters. The RD-48 is designed to be mounted on a standard 35 mm DIN-rail.

2. Safety



General:

Before using this unit, read this manual completely and gather all information on the unit. Make sure that you understand it fully. Check that your application does not exceed the safe operating specifications for this unit.



Before installation, maintenance or modification work:

Prevent damage to internal electronics from electrostatic discharges (ESD) by discharging your body to a grounding point (e.g. use of wrist strap).

Prevent access to hazardous voltages by disconnecting the unit from AC/DC mains supply and all other electrical connections.



Installation:

This unit should only be installed by qualified personnel.

This unit should only be installed in a “restricted access area”, for example a lockable cabinet where access is restricted to service personnel only.

This unit is intended for permanent connection to the AC/DC mains supply.

The power supply wiring must be sufficiently fused, and if necessary it must be possible to disconnect manually from the AC/DC mains supply. Ensure compliance to national installation regulations.

Unit with the rated voltage exceeding 42.4 V peak or 60 VDC, is defined as class I equipment with a protective earthing conductor terminal.

Unit with the rated voltage up to 42.4 V peak or 60 VDC, is defined as class III equipment and shall be separated from hazardous voltage by double or reinforced insulation.

This unit uses convection cooling. To avoid obstructing the air flow around the unit, follow the spacing recommendations (see under chapter Installation).

3. Approvals

Conformity with the Directive 2006/95/EC (Low Voltage Directive) has been assessed by application of the standard EN 60950-1.

Conformity with the Directive 2004/108/EC (Electromagnetic compatibility) has been assessed by application of standards EN 61000-6-2 (industrial immunity) and EN 61000-6-3 (residential emission).

4. Specifications

4.1 Connections

Power interface

Model description	RD-48 LV	RD-48 LV TEMP	RD-48 HV
Rated voltage	12–48 VDC		95–240 VAC 110–250 VDC
Operating voltage	9.6–57.6 VDC		85.5–264 VAC 88–300 VDC
Rated current	300 mA		50 mA
Rated frequency	–		48–62 Hz
Polarity	Reverse polarity protected		Polarity independent
Connection	2-position screw terminal		3-position screw terminal
Connector size	0.2 – 2.5 mm ² (AWG 24-12)		
Fuse	To be externally fused.		

RS-422/485 interface – Line A

Electrical specification	RS-422/485
Data rate	300 bit/s – 1.5 Mbit/s
Connection	4-position screw terminal
Connector size	0.2 – 2.5 mm ² (AWG 24-12)
Circuit type	TNV-1

RS-422/485 interface – Line B

Electrical specification	RS-422/485
Data rate	300 bit/s – 1.5 Mbit/s
Connection	4-position screw terminal
Connector size	0.2 – 2.5mm ² (AWG 24-12)
Circuit type	TNV-1

4.2 Insulation between interfaces

Power (RD-48 HV) to all other	3.0 kV RMS @ 50Hz and 60 s duration
Power (RD-48 LV) to all other	1.0 kV RMS @ 50Hz and 60 s duration
Line-A to Line-B	1.5 kV RMS @ 50Hz and 60 s duration

4.3 Climatic environment

Temperature, operating	5 to 55°C –40 to 70°C (TEMP version)
Temperature, storage and transportation	–40 to 70°C
Relative humidity, operating	5 to 95% (non-condensing)
Relative humidity, storage and transportation	5 to 95% (condensation allowed outside packaging)

4.4 Mechanics

Dimension (W x H x D)	55 x 128 x 100 mm
Weight	0.3 kg
Mounting	Snap on mounting to 35 mm DIN-rail
Degree of protection	IP 20 (IEC 529)

5. Maintenance

No maintenance is required, as long as the unit is used as intended within the specified conditions.

6. Installation

6.1 Mounting / Removal



Before mounting or removing the unit:

Prevent damage to internal electronics from electrostatic discharges (ESD) by discharging your body to a grounding point (e.g. use of wrist strap).

Prevent access to hazardous voltages by disconnecting the unit from AC/DC mains supply and all other electrical connections.

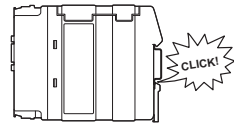
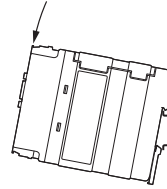

Mounting

This unit should be mounted on 35 mm DIN-rail which is horizontally mounted on a wall or cabinet backplate.

This unit use convention cooling. To avoid obstructions to the airflow around the unit, use the following spacing rules. Recommended spacing 25 mm (1.0 inch) above/below and 10 mm (0.4 inches) left/right the unit.

Snap on mounting, see figure

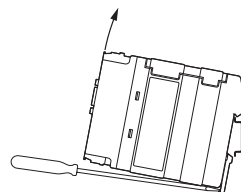
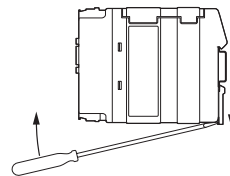
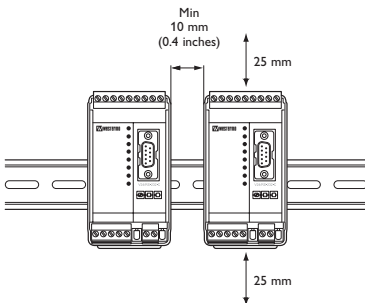

Removal

Press down the black support at the back of the unit using a screwdriver, see figure.

6.2 Connections

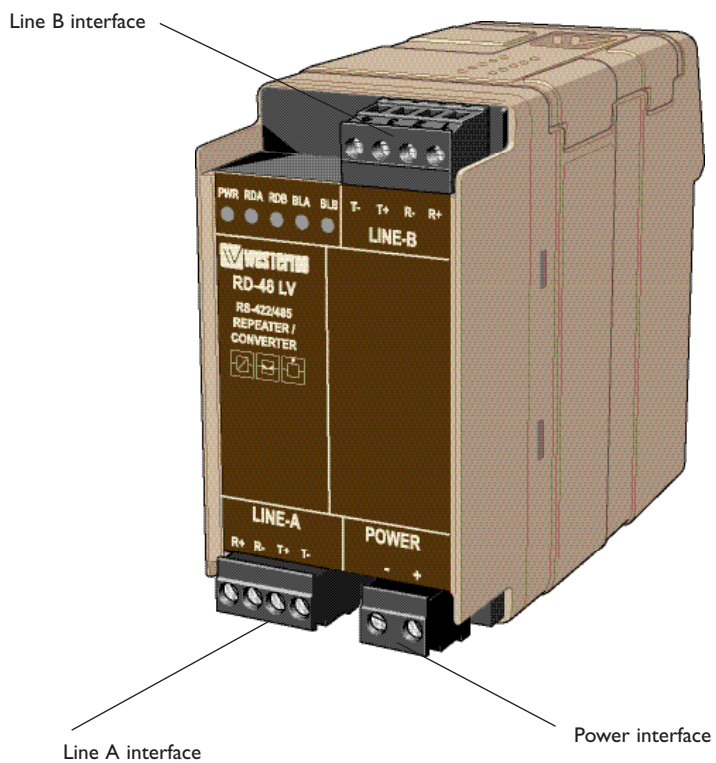



6.2.1 Power (RD-48 HV)

3-pos screw terminal	Description
L	Power AC line / Power DC
N	Power AC neutral / Power DC
	Power AC protective earth



6.2.2 Power (RD-48 LV / RD-48 LV TEMP)

2-pos screw terminal	Description
No. 1	Power DC –
No. 2	Power DC +

6.2.3 Line A RS-422/485



4-pos screw terminal	Direction	Description
No. 1	In	R+ RS-422 receiver
No. 2	In	R– RS-422 receiver
No. 3	In/Out	T+ RS-422/485 transmitter/receiver
No. 4	In/Out	T– RS-422/485 transmitter/receiver

6.2.4 Line B RS-422/485



4-pos screw terminal	Direction	Description
No. 1	In	R+ RS-422 receiver
No. 2	In	R– RS-422 receiver
No. 3	In/Out	T+ RS-422/485 transmitter/receiver
No. 4	In/Out	T– RS-422/485 transmitter/receiver

6.3 Indicators

6.3.1 LED indicators

PWR	LED on LED off	Internal power correct No internal power
RDA	LED on LED off	Received data line A No data line A
RDB	LED on LED off	Received data line B No data line B
BLA	LED on LED off	Blocking line A No blocking line A
BLB	LED on LED off	Blocking line B No blocking line B

6.4 DIP switch settings

DIP-switches is assessable under the lid on top/front of the unit. DIP-switches are used to configure the repeater.



Warning!

Prevent damage to internal electronics from electrostatic discharges (ESD) by discharging your body to a grounding point (e.g. use of wrist strap), before the lid on top of the modem is removed.



Warning! Do not open connected equipment.

Prevent access to hazardous voltages by disconnecting the unit from AC/DC mains supply and all other electrical connections.

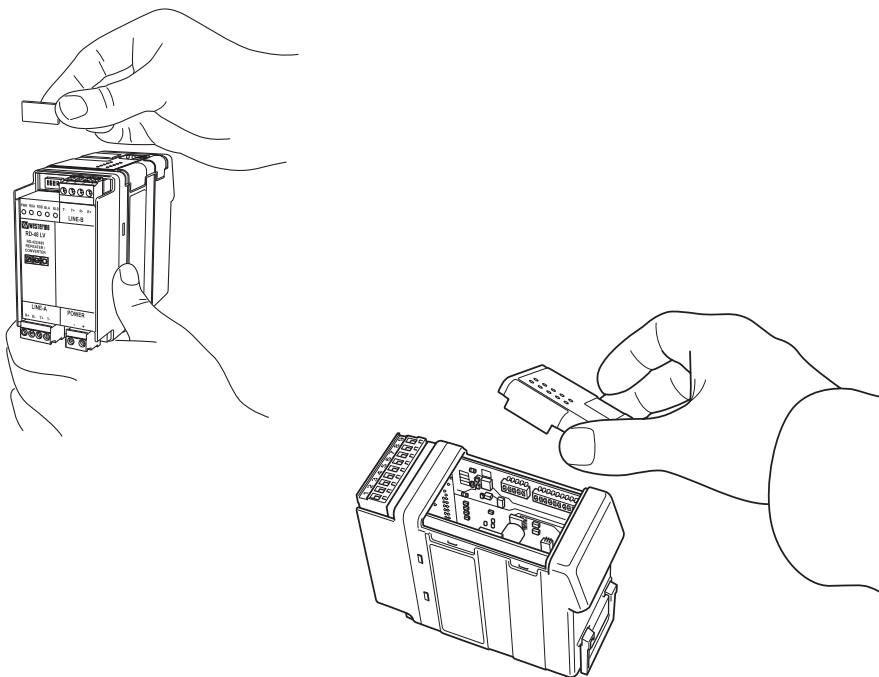

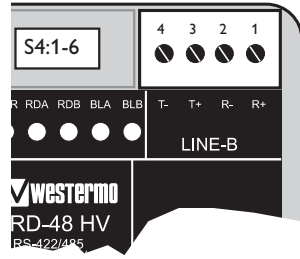
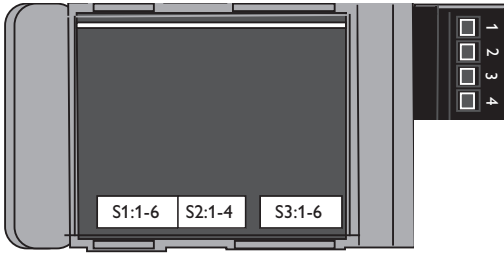

Switch block 1 – S1

Data rate



300 bit/s

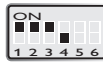

57 600 bit/s



1 200 bit/s



93 750 bit/s



2 400 bit/s



115,2 kbit/s



4 800 bit/s



187,5 kbit/s



9 600 bit/s



375 kbit/s

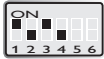

19 200 bit/s

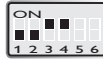

500 kbit/s

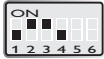

38 400 bit/s

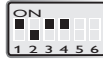

1 500 kbit/s

Format settings



9 bits format



10 bits format

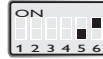

11 bits format

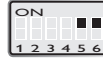

Synchronous format

1–2 bits turning time at all speed and format settings

Switch block 2 – S2

Operating mode



Retiming inactive

Line A



4-wire

Line B



4-wire



Retiming active



2-wire



2-wire



Anti-blocking inactive



Anti-blocking active

Switch block 3 – S3 RS-422/485 setting Line-A



Inactive
fail-safe 4-wire

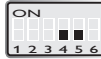

Inactive
fail-safe 2-wire



Active
fail-safe 4-wire



Active
fail-safe 2-wire



No termination
4-wire



No termination
2-wire

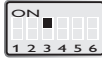

Termination
4-wire

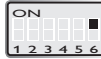

Termination
2-wire

Switch block 4 – S4 RS-422/485 setting Line-B



Inactive
fail-safe 4-wire



Inactive
fail-safe 2-wire

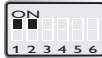

Active
fail-safe 4-wire

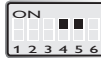

Active
fail-safe 2-wire



No termination
4-wire



No termination
2-wire

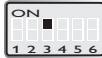

Termination
4-wire

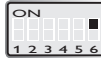

Termination
2-wire

Factory settings



S1 9 600 bit/s,
10 bit format



S3 No termination,
inactive fail-safe



S2 Anti blocking active,
Retiming inactive



S4 No termination,
inactive fail-safe

7. Functional description

7.1 Operating modes

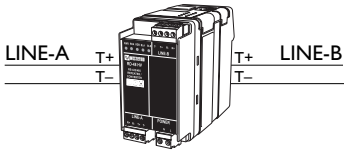

RS-485 repeater

This operating mode is used to extend / increase number of loads on a 2-wire (RS-485) bus.

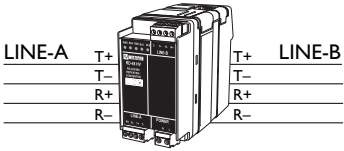

RS-422 repeater

This operating mode is used to extend / increase number of loads on a 4-wire (RS-422) bus.

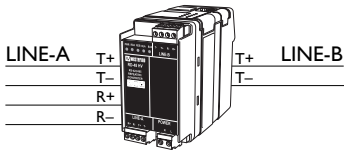

RS-422/485 converter

This operating mode is used to convert between 2- (RS-485) and 4-wire (RS-422) communication.

N.B! R+/R-, T+/T- definitions are not standard. It can help to switch polarity.

7.2 Selection of datarate / format

The data rate and format settings is used to decide the turning time on the RS-422/485 bus. For optimum performance the data rate and format settings needs to be set up according to the used protocol.

The data rate switches selects the operating speed on both line-A and line-B. Observe that the RD-48 is a transparent unit and the data rate needs to be the same on both sides of the unit.

The format switches selects the data format on both line-A and line-B. 9,10 or 11-bit format is used for asynchronous protocols. Synchronous mode activates the transmitter for 11 bits after a detected edge in data. This mode is used for synchronous protocols.

7.3 Setting of retiming

Retiming is possible on higher data rates (187.5 kbit/s and higher) and recreates the data bits to exact bit length set up by the speed selection. The use of retiming makes it possible to connect an increased number of RD-48 units on a line.

7.4 Setting of anti-blocking

The anti blocking function secures transmission on each side of the RD-48 repeater. If the line is constant active (blocked) for more than 50 ms the anti blocking function will disconnect this side of the repeater. This makes it possible to communicate between units on the other side of the repeater. When the line is cleared the repeater will automatically reconnect the disconnected side.

7.5 Selection of RS-422/485 setting

When an RS-422/485 system is installed it should always form a bus structure. Using the RD-48, it is possible to produce a star network of several busses. It is important to terminate RS-422/485 equipment correctly. In standard networks the fail-safe function should also be connected which is provided to push the unit to a defined state when the RS-422/485 line becomes undefined. The RD-48 relies on this for operation.

We recommend connection of termination and fal-safe as shown in the application note.

8. Block diagram

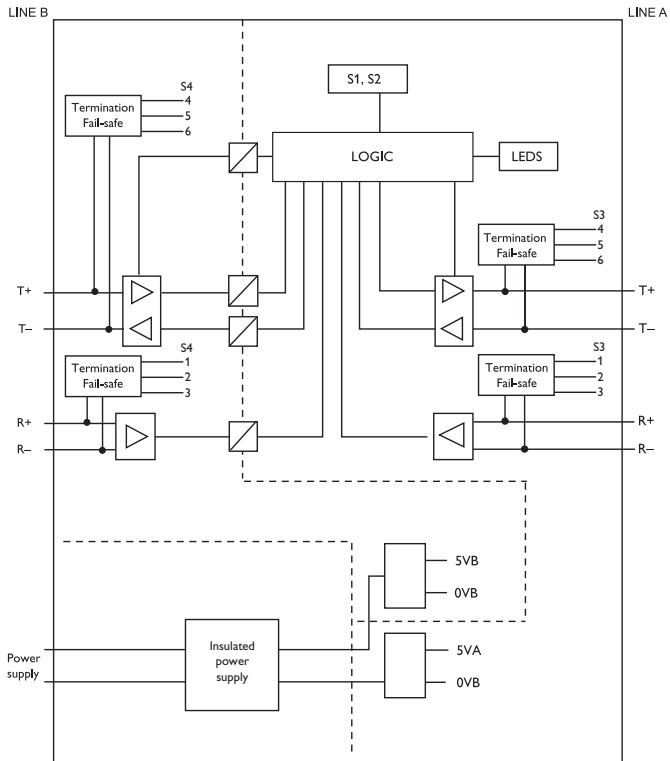

9. Application example

Normally star networks is not allowed in RS-422/485 applications. Using the RD-48 makes it possible to create branches up to 1200 m. Observe that the RD-48 should be connected a maximum of 30 cm from the bus.

Observe setting of termination and fail-safe.

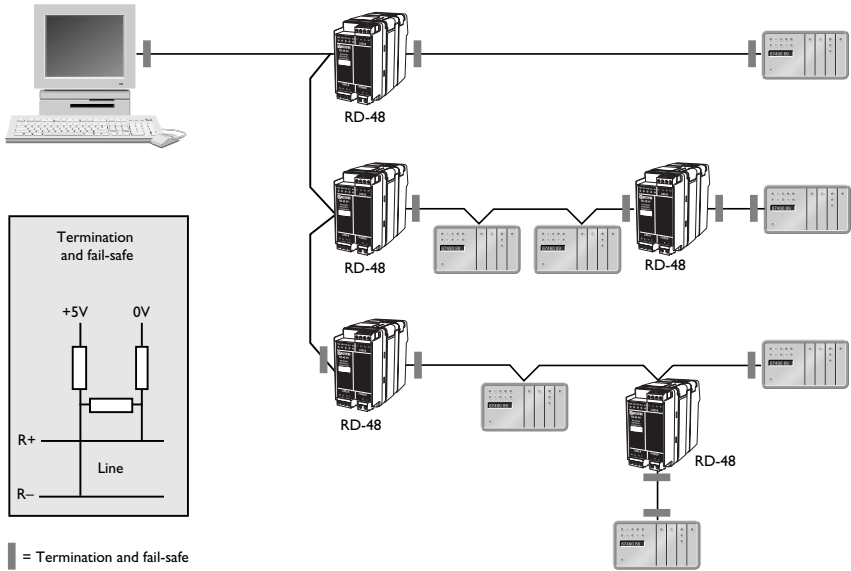

Note ! It is not possible to have more than 8 repeaters in serial connection

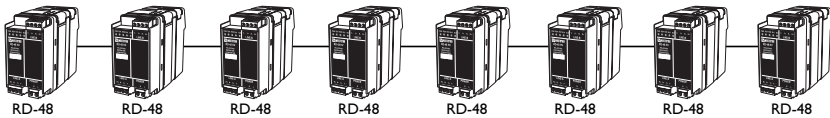

Inhalt

1. Einleitung	31
2. Sicherheitshinweise	31
3. Zulassungen	31
3.1 Vereinfachte EU Konformitätserklärung	56
4. Technische Daten	32
4.1 Anschlüsse	32
4.2 Isolation zwischen Schnittstellen	32
4.3 Umgebungsbedingungen	32
4.4 Mechanische Daten	33
5. Wartung	33
6. Installation	33 – 38
6.1 Installation/Deinstallation	33
6.2 Anschlüsse	34
6.2.1 Spannungsversorgung (RD-48 HV)	35
6.2.2 Spannungsversorgung (RD-48 LV/RD-48 LV TEMP)	35
6.2.3 Leitungsanschluss A RS-422/485	35
6.2.4 Leitungsanschluss B RS-422/485	35
6.3 Anzeigen	35
6.3.1 LED Anzeigen	35
6.4 DIP-Schalter Einstellung	36 – 38
7. Funktionsbeschreibung	39 – 40
7.1 Betriebsarten	39
7.2 Einstellung Datenrate/Format	40
7.3 Einstellung und Retiming	40
7.4 Einstellung und Antiblocking	40
7.5 Einstellung RS-422/485	40
8. Blockschaltbild	41
9. Applikationsbeispiele	43

1. Einleitung

Der RD-48 ist ein industrieller Repeater für RS-422/485 Busnetze. Desweiteren kann er als Konverter zwischen 2- und 4-Draht Systemen eingesetzt werden, und als Isolator zum Schutz vor Transienten oder Überspannungen.

Der Standard RS-422/485 Bus unterstützt 32 Slaves bei einer Distanz von 1200 m. Der RD-48 ermöglicht weitere 31 Slaves und max. 1200 m. Der RD-48 ist für die Montage auf einer Standard 35 mm Hutschiene entwickelt.

2. Sicherheitshinweise



Allgemeines:

Vor dem Einsatz des Gerätes ist die Bedienungsanleitung vollständig zu lesen. Überprüfen Sie, dass der Einsatz dieser Geräte keine Vorschriften verletzt, und den Spezifikationen des Geräts entspricht.



Vor der Installation, Wartung oder Modifikation:

Vermeiden Sie Schaden an der Elektronik durch elektrostatische Aufladung (ESD) indem Sie sich vorher an einem Erdpunkt entladen (z.B. Einsatz eines Erdarmbandes).

Vermeiden Sie durch Abziehen der Spannungsversorgung, dass stromführende Teile berührt werden können.



Installation:

Es sollte nur in einem gesicherten Umfeld betrieben werden, zu dem nur Servicepersonal Zutritt hat.

Die Einheit ist zum permanenten Anschluss an AC/DC Spannungsversorgungen gedacht und darf nur von geeignetem Personal installiert werden.

Die AC/DC Versorgungsleitungen sind ausreichend abzusichern, und eine manuelle Unterbrechungsmöglichkeit ist bei Bedarf vorzusehen. Beachten Sie auch die nationalen Vorschriften zu diesem Thema.

Ein Gerät welches mit mehr als 42.4V Spitze oder 60V DC arbeitet, ist als Class I Gerät mit Schutzterde Anschluss ausgewiesen.

Ein Gerät welches mit weniger als 42.4V Spitze oder 60V DC arbeitet, ist als Class III Gerät ausgewiesen, und sollte gegenüber Hochspannungen, durch verdoppelte oder externe Isolationen, separiert werden.

Zur Kühlung des Gerätes wird die Außenluft benutzt, daher sollte die Luftströmung um das Gerät nicht gestört sein. Siehe Installationshinweise.

3. Zulassungen

Die Konformität zur Direktive 2006/95/EC (Niederspannungs Richtlinien) wurde durch das Einbinden des Standards EN 60950-1 erzielt.

Die Konformität mit der Richtlinie 2004/108/EC (Elektromagnetische Kompatibilität) wurde durch Einbinden des Applikationsstandards EN 61000-6-2 (industrielle Beeinflussung) und EN 61000-6-3 (industrielle Ausstrahlung) erzielt.

4. Technische Daten

4.1 Anschlüsse

Spannungsversorgung

Modelbeschreibung	RD-48 LV	RD-48 LV TEMP	RD-48 HV
Eingangsspannung	12–48 VDC		95–240 VAC 110–250 VDC
Betriebsspannung	9.6–57.6 VDC		85.5–264 VAC 88–300 VDC
Stromaufnahme	300 mA		50 mA
Frequenz	–		48–62 Hz
Polarität	Verpolungsschutz		Polungsunabhängig
Anschluss	2-pol. Schraubklemme		3-pol. Schraubklemme
Anschlussgröße	0.2 – 2.5 mm ² (AWG 24-12)		
Sicherung	Muss extern abgesichert werden		

RS-422/485 Schnittstelle – Leitung A

Elektrische Daten	RS-422/485
Übertragungsrate	300 – 1,5 Mbit/s
Anschluss	4 pol. Schraubklemme
Anschlussgröße	0,2 – 2,5 mm ² (AWG 24-12)
Anschlussstyp	TNV-1

RS-422/485 Schnittstelle – Leitung B

Elektrische Daten	RS-422/485
Übertragungsrate	300 – 1,5 Mbit/s
Anschluss	4 pol. Schraubklemme
Anschlussgröße	0.2 – 2.5 mm ² (AWG 24-12)
Anschlussstyp	TNV-1

4.2 Isolation zwischen Schnittstellen

Spannung (RD-48 HV) zu allen	3,0 kV RMS @ 50 Hz und 60 s Dauer
Spannung (RD-48 LV) zu allen	1,0 kV RMS @ 50 Hz und 60 s Dauer
Leitung A zu Leitung B	1,5 kV RMS @ 50 Hz und 60 s Dauer

4.3 Klimatische Bedingungen

Betriebstemperatur	5 bis 55°C –40 bis 70°C (TEMP version)
Lager- und Transporttemperatur	–40 bis 70°C
Relative Luftfeuchtigkeit, Betrieb	5 bis 95% nicht kondensierend
Relative Luftfeuchtigkeit, Lager- und Transport	5 bis 95% kondensierend außerhalb Verpackung

4.4 Mechanisch

Abmessungen (BxHxT)	55 x 128 x 100 mm
Gewicht	0,3 kg
Montage	Schnappbar auf 35 mm DIN-Hutschiene
Schutzklasse	IP 20 (IEC 529)

5. Wartung

Es sind keine Wartungsarbeiten notwendig, solange das Gerät innerhalb seiner Spezifikation eingesetzt wird.

6. Installation

6.1 Montage/Demontage



Vor der Montage oder Demontage des Geräts:

Vermeiden Sie Schaden an der Elektronik durch elektrostatische Aufladung (ESD) indem Sie sich vorher an einem Erdpunkt entladen (z.B. Einsatz eines Erdarmbandes).

Um ein Berühren spannungsführender Teile zu vermeiden, ist das Gerät vor der Montage/Demontage von allen Spannungsführenden Teilen abzuklemmen.

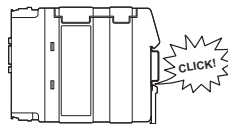
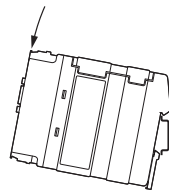

Montage

Das Gerät ist für die Montage auf einer horizontalen 35mm Hutschiene vorgesehen. Zur Kühlung des Gerätes müssen bestimmte Mindestabstände eingehalten werden. Über und unter dem Gerät min. 25mm (1.0 Inch) und links und rechts min. 10mm (0.4 Inches).

Aufschnapp Montage (Skizze)

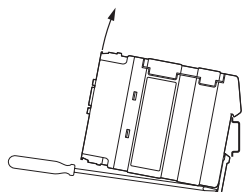
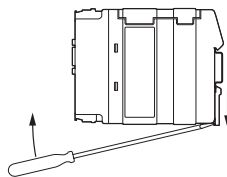
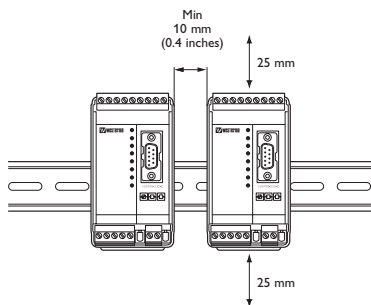

Demontage

Die schwarze Halterung auf der Unterseite mit einem Schraubendreher nach unten ziehen und das Gerät nach oben von der Hutschiene nehmen (Skizze).

6.2 Anschlüsse

Leitungsschnittstelle B

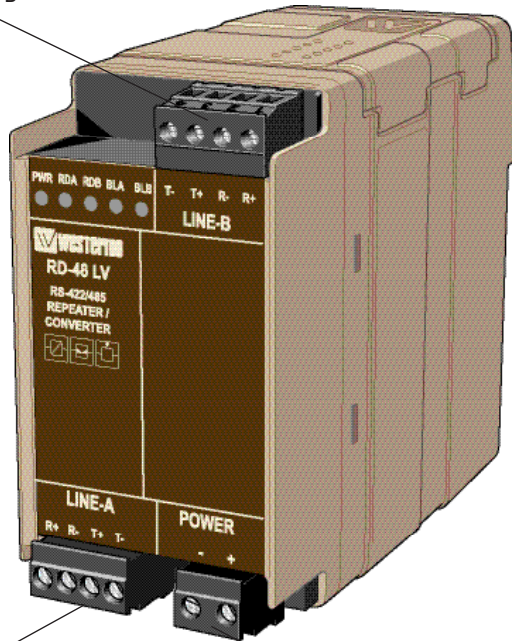

Leitungsschnittstelle A

Spannungsanschluss

6.2.1 Spannungsversorgung (RD-48 HV)



3-pol. Schraubklemme	Beschreibung
L	Phase
N	Neutralleiter
	Schutzerde

6.2.2 Spannungsversorgung (RD-48 LV / RD-48 LV TEMP)



2-pol. Schraubklemme	Beschreibung
Nr. 1	– Spannung
Nr. 2	+ Spannung

6.2.3 Leitungsschnittstelle A RS-422/485



4-pol. Schraubklemme	Richtung	Beschreibung
Nr. 1	In	R+ RS-422 Empfänger
Nr. 2	In	R– RS-422 Empfänger
Nr. 3	In/Out	T+ RS-422/485 Sender/Empfänger
Nr. 4	In/Out	T– RS-422/485 Sender/Empfänger

6.2.4 Leitungsschnittstelle B RS-422/485



4-pol. Schraubklemme	Richtung	Beschreibung
Nr. 1	In	R+ RS-422 Empfänge
Nr. 2	In	R– RS-422 Empfänge
Nr. 3	In/Out	T+ RS-422/485 Sender/Empfänger
Nr. 4	In/Out	T– RS-422/485 Sender/Empfänger

6.3 Anzeigen

6.3.1 LED Anzeigen

PWR	LED An LED Aus	Spannungsversorgung OK Keine interne Spannung
RDA	LED An LED Aus	Empfangene Daten an Leitung A Keine Daten an Leitung A
RDB	LED An LED Aus	Empfangene Daten an Leitung B Keine Daten an Leitung B
BLA	LED An LED Aus	Blocking auf Leitung A Kein Blocking auf Leitung A
BLB	LED An LED Aus	Blocking auf Leitung B Kein Blocking auf Leitung B

6.4 DIP-Schalter Einstellung

Die DIP-Schalter sind über die obere Abdeckung zugänglich. Über die DIP-Schalter kann das Gerät konfiguriert werden.



WARNUNG!

Vermeiden Sie Schaden an der Elektronik durch elektrostatische Aufladung (ESD) indem Sie sich vorher an einem Erdpunkt entladen (z.B. Einsatz eines Erdarmbandes), bevor sie den Deckel abnehmen.



WARNUNG! Keine angeschlossenen Geräte öffnen.

Um ein Berühren spannungsführender Teile zu vermeiden, ist das Gerät vor der Montage/Demontage von allen Spannungsführenden Teilen abzuklemmen.

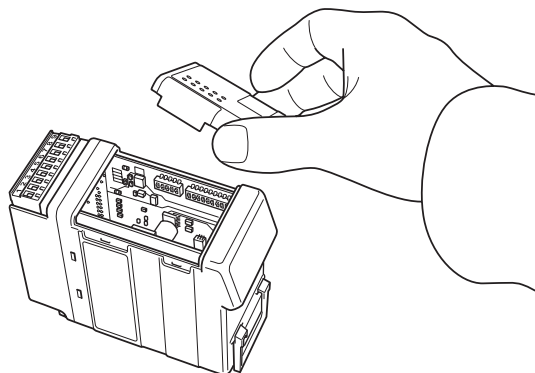
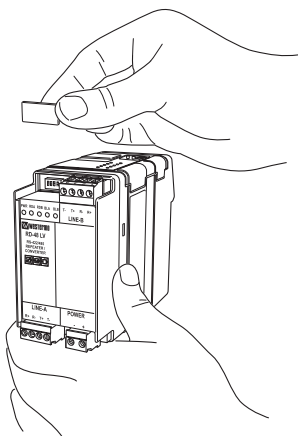

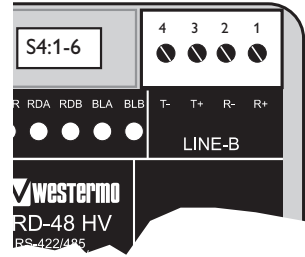
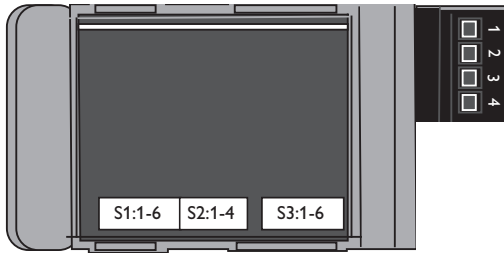

DIP-Schalterblock 1 – S1

Übertragungsrate



300 Bit/s



57 600 Bit/s



1 200 Bit/s



93 750 Bit/s

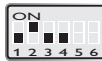

2 400 Bit/s

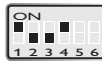

115,2 Kbit/s



4 800 Bit/s



187,5 Kbit/s



9 600 Bit/s



375 Kbit/s

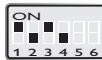

19 200 Bit/s

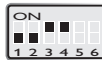

500 Kbit/s



38 400 Bit/s



1 500 Kbit/s

Formateinstellung



9 Bits
Format



10 Bits
Format

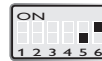

11 Bits
Format



Synchronformat

1-2 Bits Umschaltzeit bei allen
Geschwindigkeiten und
Formateinstellungen

DIP-Schalterblock 2 – S2

Betriebsart



Retiming inaktiv



Retiming aktiv



Anti Blocking inaktiv



Anti Blocking aktiv

Leitung A



4-Draht



2-Draht

Leitung B



4-Draht



2-Draht

DIP-Schalterblock 3 – S3

RS-422/485 Einstellungen Leitung A



4-Draht
Failsafe Deaktiviert

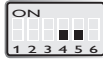

2-Draht
Failsafe Deaktiviert



4-Draht
Failsafe Aktiviert



2-Draht
Failsafe Aktiviert



Keine Termination
4-Draht

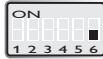

Keine Termination
2-Draht

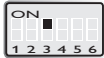

Termination
4-Draht



Termination
2-Draht

DIP-Schalterblock 4 – S4

RS-422/485 Einstellungen Leitung B



4-Draht
Failsafe Deaktiviert



2-Draht
Failsafe Deaktiviert



4-Draht
Failsafe Aktiviert

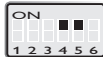

2-Draht
Failsafe Aktiviert



Keine Termination
4-Draht



Keine Termination
2-Draht



Termination
4-Draht



Termination
2-Draht

Werkseinstellung



S1 9600Bit/s
10 Bit Format



S3 Keine Termination,
Fail Safe inaktiv



S2 Anti Blocking aktiv,
Retiming inaktiv



S4 Keine Termination,
Fail Safe inaktiv

7. Funktionsbeschreibung

7.1 Betriebsarten

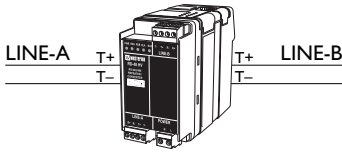

RS-485 Repeater

Zur Erweiterung der Leitungslänge und Anzahl der Lasten auf einem 2-Draht RS-485 Bus.

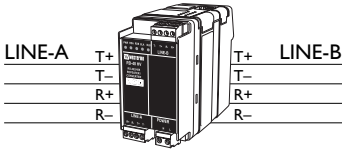

RS-422 Repeater

Zur Erweiterung der Leitungslänge und Anzahl der Lasten auf einem 4-Draht RS-422 Bus.

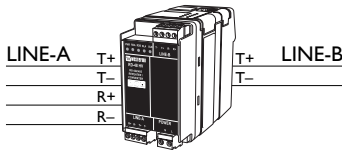

RS-422/485 Konverter

Wird benutzt, um zwischen 2-Draht RS-485 und 4-Draht RS-422 Netzen zu wandeln.

Hinweis: R+/R-, T+/T- sind keine Standards. Bei Problemen hilft es oftmals die Polarität zu tauschen.

7.2 Einstellung der Datenrate / Format

Durch diese Einstellung wird die Umschaltzeit des RS-485/422 Bus beeinflusst. Für einen optimalen Betrieb muss die Datenrate und das Datenformat auf das benutzte Protokoll angepasst werden.

Der DIP-Schalter für die Datenrate beeinflusst beide (A & B) Schnittstellen. Beachten Sie bitte, dass der RD-48 ein transparenter Repeater ist, und daher die Datenrate auf beiden Schnittstellen gleich sein muss.

Der Format Schalter stellt für beide Schnittstellen 9, 10 oder 11 Bit für asynchrone Protokolle ein. Bei synchroner Betriebsart bleibt der Sender für 11 Bits nach einer Flanke in den Daten eingeschaltet. Dies wird nur bei synchronen Protokollen benutzt.

7.3 Retiming Einstellung

Retiming ist bei höheren (187.5Kbit/s oder höher) möglich und regeneriert die Datenbits auf Ihre exakte Länge, anhand der Datenraten Einstellung. Durch diese Funktion wird es möglich, mehr RD-48 auf einer Leitung einzusetzen.

7.4 Anti Blocking Einstellung

Die Anti Blocking Funktion sichert die Übertragung auf beiden Seiten des RD-48 Repeaters. Ist die Leitung konstant auf High Pegel (blockiert) für mehr als 50 ms, so wird durch die Anti Blocking Funktion diese Seite des Repeaters abgeschaltet. Dies sichert eine Übertragung auf der anderen Schnittstelle des Repeaters. Ist die Leitung wieder in Ordnung, wird diese automatisch wieder eingeschaltet.

7.5 Einstellungen für RS-422/485

Wenn ein RS-422/485 System aufgebaut wird, sollte es immer Bus Struktur haben. Durch den RD-48 ist es auch möglich, Sternnetze aufzubauen. Es ist auch wichtig, bei RS-422/485 Geräten die richtige Termination zu setzen. In Standard Netzwerken sollte auch die Fail-Safe Funktion aktiviert sein. Diese setzt den RD-48 in einen definierten Zustand, wenn die RS-422/485 Leitung undefiniert wird. Für eine einwandfreie Funktion benötigt der RD-48 dieses.

Wir empfehlen den Einsatz der Termination und des Fail-Safe, wie in den Applikationsbeispielen gezeigt.

8. Blockdiagramm

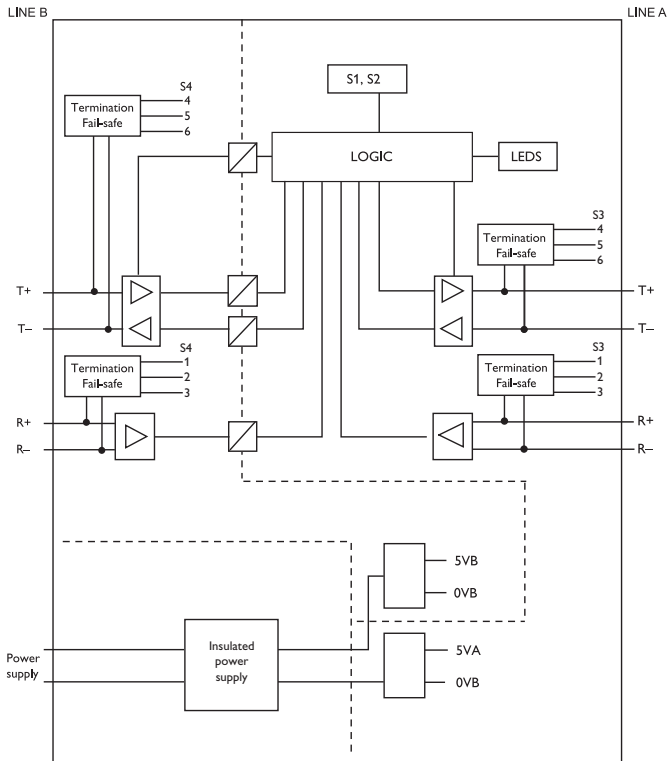

9. Applikationsbeispiel

Sternnetzwerke sind in RS-422/485 Applikationen normalerweise nicht erlaubt. Durch den RD-48 werden Übertragungen bis 1200m ermöglicht. Der RD-48 sollte nicht weiter als 30cm vom Bus entfernt sein.

Termination und Fail-Safe beachten.

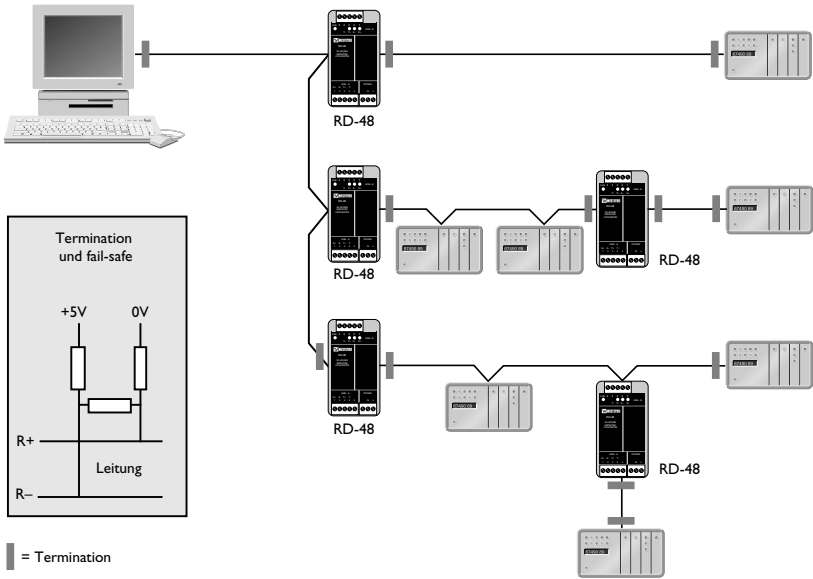

Hinweis! Es ist nicht möglich mehr als 8 Repeater in Reihe zu schalten

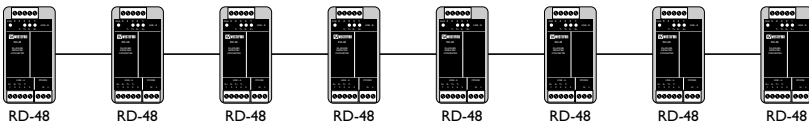

Tables des matières

1. Introduction	44
2. Sécurité	44
3. Homologation	44
3.1 Déclaration de conformité UE simplifiée	56
4. Spécifications	45
4.1 Connexions	45
4.2 Isolation entre interfaces	45
4.3 Environnement climatique	45
4.4 Mécanique	46
5. Maintenance	46
6. Installation	46 – 51
6.1 Fixation/Démontage	46
6.2 Connexions	47
6.2.1 Alimentation (RD-48 HV)	48
6.2.2 Alimentation (RD-48 LV/RD-48LV TEMP)	48
6.2.3 Ligne A RS-422/485	48
6.2.4 Ligne B RS-422/485	48
6.3 Indicateurs	48
6.3.1 Indicateurs de statut LED	48
6.4 Configuration Interrupteurs DIP	49 – 51
7. Description fonctionnelle	52 – 53
7.1 Modes de fonctionnement	52
7.2 Configuration vitesse et format	53
7.3 Configuration et re-synchronisation	53
7.4 Configuration et anti-blocage	53
7.5 Configuration de l'interface RS-422/485	53
8. Diagramme simplifié	54
9. Exemple d'application	55

1. Introduction

Le RD-48 est un répéteur industriel pour les bus RS-422/485. Il peut également être utilisé comme un convertisseur entre des systèmes de communication 2 et 4 fils ou bien comme isolateur contre les états transitoires et les surtensions.

Le standard RS-422/485 supporte 32 équipements sur une distance de 1200 mètres.

Le RD-48 vous procure une nouvelle section de 31 équipements sur 1200 mètres.

Le RD-48 est conçu pour être fixé sur un rail DIN 35 mm.

2. Sécurité



Généralités :

Lire le manuel en détails et s'assurer de la bonne compréhension de son contenu avant de mettre en service cet équipement.

Vérifier que votre application n'excède pas les spécifications techniques de fonctionnement de cet équipement.



Avant toute intervention sur ce matériel :

Afin d'éviter tout risque de destruction par décharges électrostatiques (OSD) des éléments internes, référez votre corps à la terre (Par ex : utiliser des bracelets antistatiques).



Installation :

Cet équipement est conçu pour un usage industriel. Il doit être installé dans un local technique dont l'accès est limité aux seules personnes autorisées.

Cet équipement est destiné à être alimenté en permanence par une source AC/DC et ne peut être installé que par du personnel qualifié.

La source d'alimentation AC/DC doit comporter des protections électriques adaptées et doit permettre autant que possible de débrancher manuellement l'équipement.

S'assurer de la bonne conformité de l'installation avec la réglementation nationale en vigueur.

Tout équipement ayant une tension d'alimentation dépassant 42,4V crête ou 60V DC est un équipement de classe I et doit être raccordé à la terre.

Tout équipement ayant une tension d'alimentation allant jusqu'à 42,4V crête ou 60V DC est un équipement de classe III et doit être séparé des tensions dangereuses par une double isolation renforcée.

Cet équipement utilise une ventilation par convection. Veiller à laisser suffisamment d'espace tout autour de celui-ci pour permettre une bonne ventilation.

(Se reporter au chapitre installation).

3. Homologations

La conformité à la directive 2006/95/EC (Directive basse tension) a été obtenue par application du standard EN 60950-1.

La conformité à la directive 2004/108/EC (Compatibilité Electromagnétique) a été obtenue par l'application des standards EN 61000-6-2 (Immunité Industrielle) et EN 61000-6-3 (Emission résidentielle).

4. Specifications

4.1 Connexions :

Interface Alimentation

Référence Modèle	RD-48 LV	RD-48 LV TEMP	RD-48 HV
Tension d'alimentation	12–48 VDC		95–240 VAC 110–250 VDC
Plage d'alimentation	9,6–57,6 VDC		85,5–264 VAC 88–300 VDC
Consommation	300 mA		50 mA
Fréquence	–		48–62 Hz
Polarité	Protection polarité inversée		Indépendante
Connexion	Bornier à vis 2 positions		Bornier à vis 3 positions
Section conducteurs	0,2 – 2,5 mm ² (AWG 24-12)		
Fusible	Doit être équipé d'une protection externe		

Interface RS-422/485 – Ligne A

Spécifications électrique	RS-422/485
Vitesse	300 bit/s – 1,5 Mbit/s
Connexion	Bornier à vis 4 positions
Section conducteur	0,2 – 2,5 mm ² (AWG 24-12)
Type de circuit	TNV-1

Interface RS-422/485 – Ligne B

Spécifications électrique	RS-422/485
Vitesse	300 bit/s – 1,5 Mbit/s
Connexion	Bornier à vis 4 positions
Section conducteur	0,2 – 2,5 mm ² (AWG 24-12)
Type de circuit	TNV-1

4.2 Isolation entre interfaces

Alimentation (RD-48 HV) vers toutes autres :	3,0 kV RMS@ 50 Hz et durant 60 s
Alimentation (RD-48 LV) vers toutes autres :	1,0 kV RMS@ 50 Hz et durant 60 s
Ligne A vers Ligne B :	1,5 kV RMS@ 50 Hz et durant 60 s

4.3 Environnement climatique

Température de fonctionnement	5 à 55°C –40 à 70°C (Version TEMP)
Température de transport et stockage	–40 à 70°C
Humidité relative en fonctionnement	5 à 95% (Non condensée)
Humidité relative de transport et stockage	5 à 95% (condensation permise à l'extérieur de l'emballage)

4.4 Mécaniques

Dimensions	55 x 100 x 128 mm (LxHxP)
Poids	0.3 kg
Montage	Verrouillage sur rail DIN de 35 mm
Degré de protection	IP 20 (IEC 529)

5. Maintenance

Aucune intervention n'est nécessaire tant que l'équipement est utilisé dans les conditions spécifiées.

6. Installation

6.1 Fixation / Démontage



Recommandations avant de fixer ou de démonter l'équipement :

Afin d'éviter tout risque de destruction par décharges électrostatiques (ESD) des éléments internes, Référez votre corps à la terre (Par ex: utiliser des bracelets antistatiques).

Débrancher l'équipement de la source d'alimentation AC/DC ainsi que toutes les autres connexions pour éviter tout risque d'électrocution.

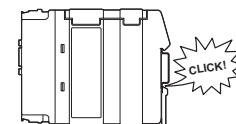
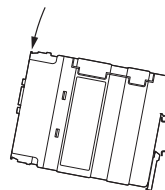

Fixation

Cet équipement doit être installé sur un rail DIN 35mm fixé horizontalement sur un mur ou dans une armoire technique.

Cet équipement utilise une ventilation par convection. Laisser un dégagement suffisant autour de l'équipement en suivant les instructions suivantes :

Zone de dégagement recommandée, Dessus/Dessous: 25 mm.

Droite/Gauche: 10 mm. Fixation par verrouillage (Voir Figure).

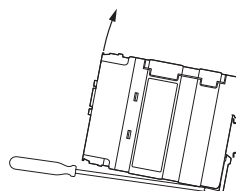
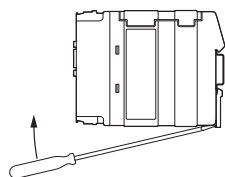
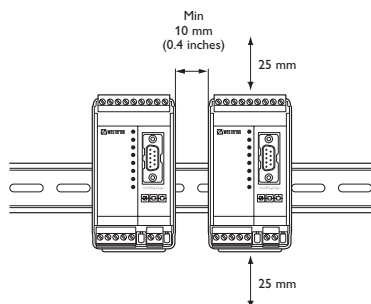

Démontage

Tirer l'agrafe noire située au dos de l'équipement vers le bas à l'aide d'un tournevis. (Voir Figure).

6.2 Connexions

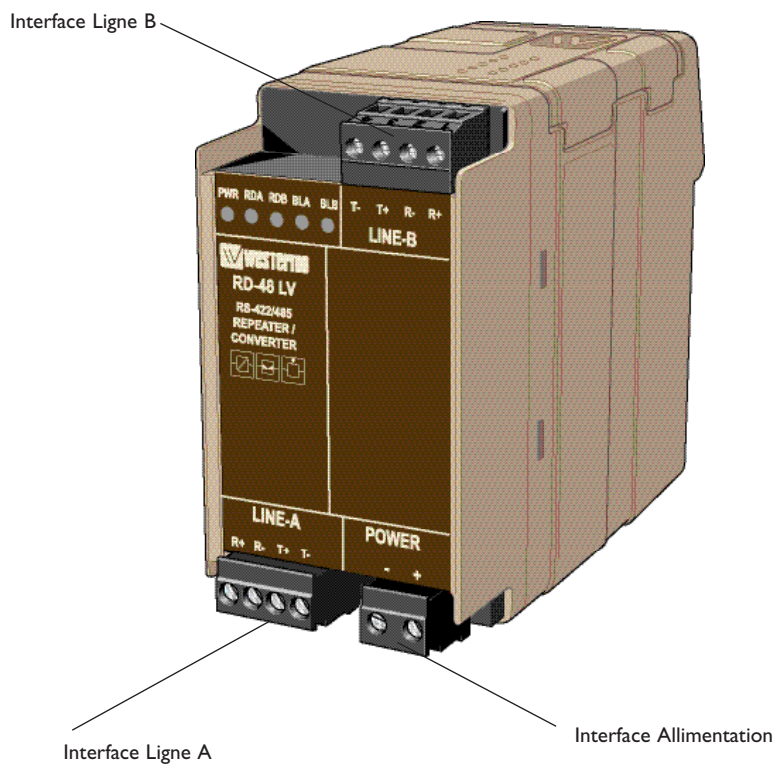



6.2.1 Alimentation (RD-48 HV)

Bornier à vis 3 positions	Description
L	(AC) Phase / (DC) Tension
N	(AC) Neutre/ (DC) Tension
	(AC) Terre de protection



6.2.2 Alimentation (RD-48 LV / RD-48 LV TEMP)

Bornier à vis 2 positions	Description
N° 1	(DC) Tension -
N° 2	(DC) Tension +



6.2.3 Ligne A RS-422/485

Bornier à vis 4 positions	Direction	Description
N° 1	Entrée	R+ Réception RS-422
N° 2	Entrée	R- Réception RS-422
N° 3	Entrée/Sortie	T+ Emission/Réception RS-422/485
N° 4	Entrée/Sortie	T- Emission/Réception RS-422/485



6.2.4 Ligne B RS-422/485

Bornier à vis 4 positions	Direction	Description
N° 1	Entrée	R+ Réception RS-422
N° 2	Entrée	R- Réception RS-422
N° 3	Entrée/Sortie	T+ Emission/Réception RS-422/485
N° 4	Entrée/Sortie	T- Emission/Réception RS-422/485

6.3 Indicateurs

6.3.1 Indicateurs LED

PWR	LED Allumée LED Eteinte	Alimentation équipement correcte Pas d'alimentation
RDA	LED Allumée LED Eteinte	Réception de données sur la ligne A Aucune donnée reçue sur la ligne A
RDB	LED Allumée LED Eteinte	Réception de données sur la ligne B Aucune donnée reçue sur la ligne B
BLA	LED Allumée LED Eteinte	Ligne A bloquée Ligne A non bloquée
BLB	LED Allumée LED Eteinte	Ligne B bloquée Ligne B non bloquée

6.4 Interrupteurs DIP

Les Interrupteurs DIP se trouvent sous le capot supérieur de l'équipement. Ils permettent la configuration du modem.



Attention!

Avant de démonter le capot du modem, référez votre corps à la terre (Par ex: utiliser des bracelets antistatiques).

Afin d'éviter tout risque de destruction par décharges électrostatiques (ESD) des éléments internes.



Attention! Ne pas ouvrir un équipement sous tension.

Pour éviter tout risque d'électrocution.

débrancher l'équipement de la source d'alimentation AC/DC ainsi que toutes les autres connections.

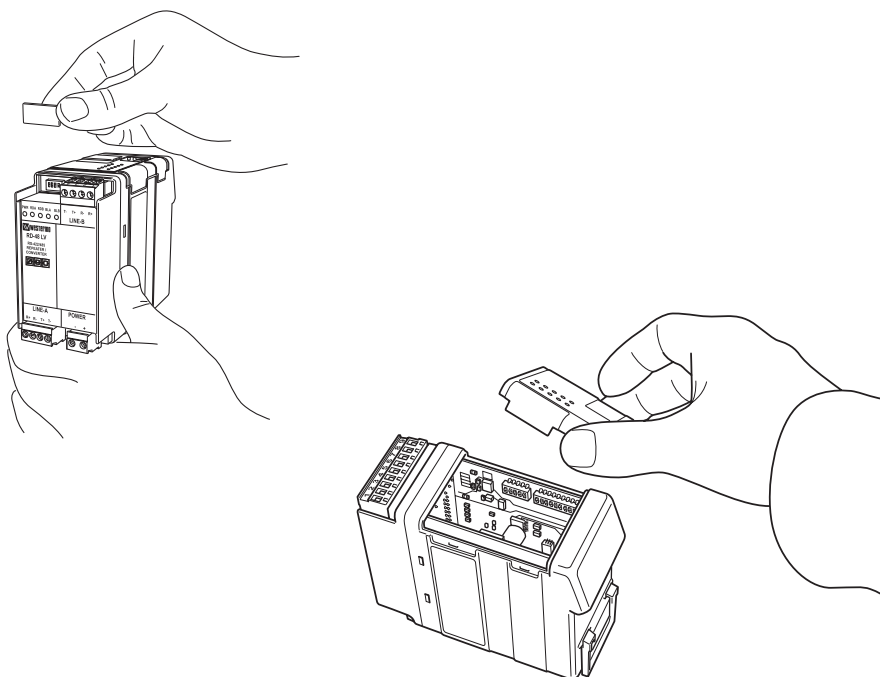

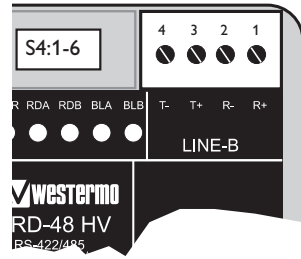
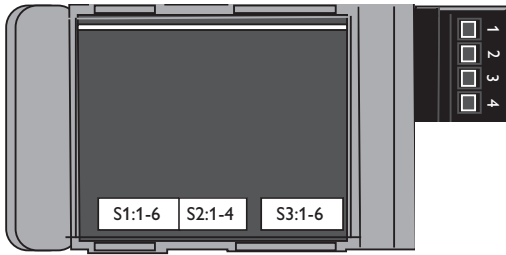

Interrupteur DIP 1 : S1

Vitesse Transmission

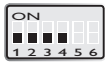

300 bit/s

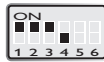

57 600 bit/s



1 200 bit/s



93 750 bit/s



2 400 bit/s



115,2 kbit/s



4 800 bit/s



187,5 kbit/s



9 600 bit/s



375 kbit/s



19 200 bit/s



500 kbit/s



38 400 bit/s



1 500 kbit/s

Configuration Format



Format
9 bits



Format
10 bits



Format
11 bits



Format
Synchrone

Temps de retournement
1-2 bits pour toute vitesse
et format sélectionné.

Interrupteur DIP 2 : S2

Modes Fonctionnels



Re-synchronisation
Inactive



Re-synchronisation
Active



Antiblocage Inactif



Antiblocage Actif

Ligne A



4 Fils



2 Fils

Ligne B



4 Fils



2 Fils

Interrupteur DIP 3 :S3

Configuration RS-422/485 Ligne A



Niveau de Sécurité
4 fils Inactif



Niveau de Sécurité 2 Fils
Inactif

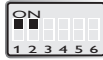

Niveau de Sécurité
4 Fils Actif

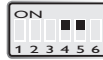

Niveau de sécurité 2 Fils
Actif



Terminaison 4 Fils
Inactive

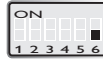

Terminaison 2 Fils
Inactive

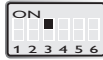

Terminaison 4 Fils
Active

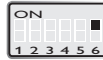

Terminaison 2 fils
Active

Interrupteur DIP 4 :S4

Configuration RS-422/485 Ligne B



Niveau de Sécurité 4 fils
Inactif



Niveau de Sécurité 2 Fils
Inactif

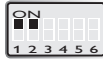

Niveau de sécurité 4 Fils
Actif

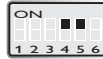

Niveau de sécurité 2 Fils
Actif



Terminaison 4 Fils
Inactive

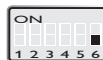

Terminaison 2 Fils
Inactive

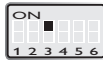

Terminaison 4 Fils
Active

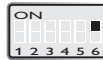

Terminaison 2 fils
Active

Configuration Usine



S1 9 600 bit/s,
Format 10 bits



S3 Pas de terminaison
Niveau de sécurité Inactif



S2 Antiblocage Actif
Re-synchronisation Inactif



S4 Pas de terminaison
Niveau de sécurité Inactif

7. Description Fonctionnelle

7.1 Modes Fonctionnels

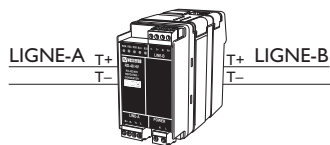

Répéteur RS-485

Ce mode permet d'étendre un bus RS-485 2 fils existant en ajoutant une nouvelle section de 1200 m /31 équipements

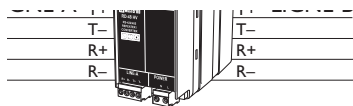

Répéteur RS-422

Ce mode permet d'étendre un bus RS-422 4 fils existant en ajoutant une nouvelle section de 1200 m /31 équipements



Convertisseur RS-422/485

Ce mode permet de raccorder un bus RS-422 4 fils avec
Un bus RS-485 2 fils

N.B! Les définitions R+/R-, T+/T- ne sont pas standard. On peut résoudre dans certains cas des problèmes de connexion si les équipements ne fonctionnent pas en inversant les polarités.

7.2 Configuration de la vitesse et du format

La configuration du débit des données et du format permet de déterminer le temps de retournement du bus RS-422/485. Pour obtenir des performances optimales, il est important que la vitesse et le format des données soient conformes à ceux utilisés par le protocole de communications.

Les interrupteurs DIP vitesse de transmission configure le débit des données globalement pour les lignes A et B. Il est à noter que le RD-48 est un équipement transparent et le débit des données doit être identique sur les deux lignes de transmission.

Les interrupteurs DIP configurant le format des données en 9,10 et 11 bits globalement pour les lignes A et B est utilisé pour la gestion de protocoles asynchrones. Le mode synchrone configure l'émetteur en 11 bits dès détection du front montant des données. Ce mode est utilisé pour des protocoles synchrones.

7.3 Configuration de la Re-synchronisation

La re-synchronisation est possible pour des débits de données élevés (187,5 Kbit/s et plus). On va recréer ainsi les bits de données à la longueur exacte telle que défini par la vitesse configurée. La re-synchronisation permet de connecter un nombre accru de RD-48 sur une même ligne.

7.4 Configuration de l'antiblocage

L'antiblocage permet de sécuriser les transmissions de chaque côté du répéteur RD-48. Si la ligne de transmission est active en permanence (Bloquée) pendant plus de 50 ms la fonction antiblocage va déconnecter la ligne correspondante du répéteur.

On permet ainsi la poursuite de la communication sur l'autre ligne du répéteur.

Lorsque la ligne en défaut est réinitialisée, le répéteur reconnecte automatiquement la ligne correspondante.

7.5 Configuration de l'interface RS-422/485

Lorsque l'on utilise une interface RS-422/485 celle ci doit toujours être définie sous la forme d'une structure bus.

L'utilisation du RD-48 permet de construire un réseau en forme d'étoile permettant la connexion de structures bus multiples.

Un réseau RS-422/485 doit toujours être équipé de terminaisons correctement installées.

La terminaison procure une fonction niveau de sécurité pour travailler correctement avec tous les convertisseurs Westermo.

La fonction niveau de sécurité permet, dans le cas où l'état de la ligne RS-422/485 devient inconnu, de forcer le niveau de l'équipement à un état défini.

Le fonctionnement du RD-48 est basé sur ce concept.

Nous recommandons donc de terminer le récepteur comme indiqué dans l'exemple d'application ci-dessous.

8. Diagramme Simplifié

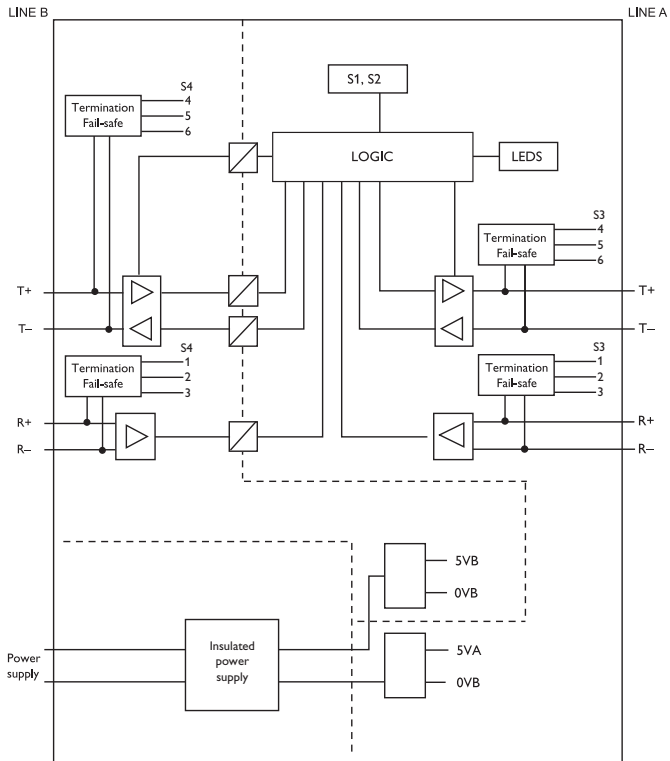

9. Exemple d'application

Dans les applications RS-422/485 les réseaux en étoile ne sont pas autorisés. L'utilisation du RD-48 permet de construire ce type de réseau en créant des branches de 1200 m. Il est à remarquer que le RD-48 doit être connecté à une distance de 30 cm maximum du bus.

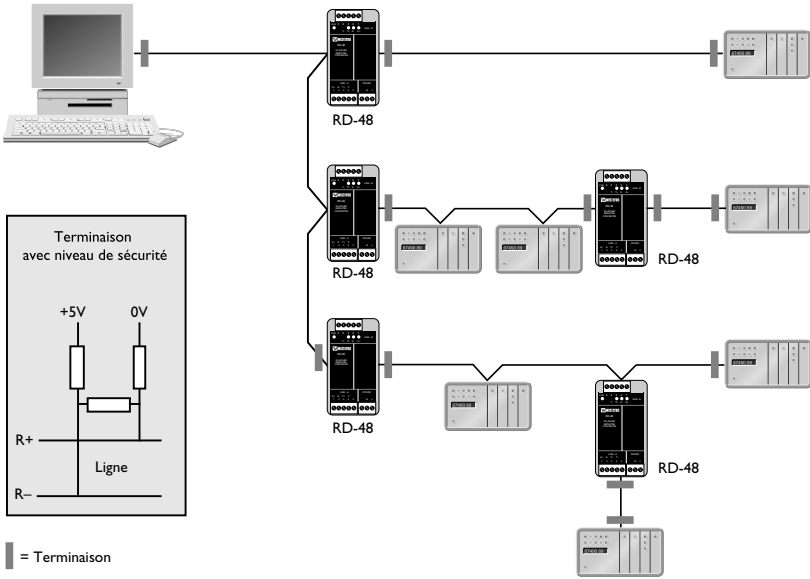

Remarque : Il n'est pas possible de connecter plus de 8 répéteurs sur une connexion série.

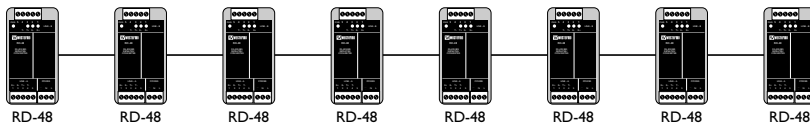

3.1 Simplified EU declaration of conformity

Förenklad EU-försäkran om överensstämmelse

Härmed försäkrar Westermo att utrustningen överensstämmer med gällande EU-direktiv. Den fullständiga EU-försäkran om överensstämmelse och annan detaljerad information finns på respektive produktsida på www.westermo.com.

Simplified EU declaration of conformity

Hereby, Westermo declares that the equipment is in compliance with applicable EU directives. The full EU declaration of conformity and other detailed information is found at the respective product page at www.westermo.com.

Vereinfachte EU Konformitätserklärung

Hiermit erklärt Westermo, dass das Gerät den EU-Richtlinien entspricht. Die vollständige EU-Konformitätserklärung und weitere detaillierte Informationen finden Sie auf der jeweiligen Produktseite unter www.westermo.de.

Déclaration de conformité UE simplifiée

Par la présente, Westermo déclare que l'équipement est conforme aux directives de l'UE. La déclaration de conformité UE complète et d'autres informations détaillées sont disponibles sur la page produit respective à l'adresse www.westermo.fr



Westermo • SE-635 35 Stora Sundby, Sweden

Tel +46 16 42 80 00 Fax +46 16 42 80 01

E-mail: info@westermo.com

www.westermo.com