



# RedFox Industrial Rack Series

Industrial Routing Switch





## General information

### Legal information

The contents of this document are provided “as is”. Except as required by applicable law, no warranties of any kind are made in relation to the accuracy and reliability or contents of this document, either expressed or implied, including but not limited to the implied warranties of merchantability and fitness for a particular purpose. Westermo reserves the right to revise this document or withdraw it at any time without prior notice.

Under no circumstances shall Westermo be responsible for any loss of data or income or any special, incidental, and consequential or indirect damages howsoever caused.

More information about Westermo can be found at [www.westermo.com](http://www.westermo.com)

### Software tools

Related software tools are available at [www.westermo.com/support/software-tools](http://www.westermo.com/support/software-tools).

### License and copyright for included Free/Libre Open Source Software

This product includes software developed by third parties, including Free/Libre Open Source Software (FLOSS). The specific license terms and copyright associated with the software are included in each software package respectively. Please visit the product web page for more information.

Upon request, the applicable source code will be provided. A nominal fee may be charged to cover shipping and media. Please direct any source code request to your normal sales or support channel.





### WeOS Management Guide

This product runs WeOS4 (Westermo Operation System). Instructions for quick start, configuration, factory reset and use of USB port are found in the WeOS user documentation at [www.westermo.com](http://www.westermo.com).

# Safety and Regulations

Warning signs are provided to prevent personal injuries and/or damages to the product.

The following levels are used:

Level of warning	Description	Consequence personal injury	Consequence material damage
 WARNING	Indicates a potentially hazardous situation	Possible death or major injury	Major damage to the product
 CAUTION	Indicates a potentially hazardous situation	Minor or moderate injury	Moderate damage to the product
 NOTICE	Provides information in order to avoid misuse of the product, confusion or misunderstanding	No personal injury	Minor damage to the product
 NOTE	Used for highlighting general, but important information	No personal injury	Minor damage to the product

## Before installation:

Read this manual completely and gather all information on the product. Make sure that you understand it fully. Check that your application does not exceed the safe operating specifications for this product.



### **WARNING - SAFETY DURING INSTALLATION**

The product must be installed by qualified service personnel and built in to an apparatus cabinet or similar, where access is restricted to service personnel only.

During installation, ensure a protective earthing conductor is first connected to the protective earthing terminal (only valid for metallic housings). Westermo recommends a cross-sectional area of at least 4 mm<sup>2</sup>.

Upon removal of the product, ensure that the protective earthing conductor is disconnected last.



### **WARNING - HAZARDOUS VOLTAGE**

Do not open an energized product. Hazardous voltage may occur when connected to a power supply.

For RedFox models with a rated voltage above 48 VDC or 30 VAC: Apply the protective cap (delivered with the product) on the power cable.



### **WARNING - PREVENT ACCESS TO HAZARDOUS VOLTAGE CABLE**

Apply the protective cap (delivered with the AC product) on the power cable, according to the illustrated steps below. To prevent accidentally pulling out wires, make sure the power cable and the wires are firmly attached to the protective cap.

For screw connectors, make sure the screws are properly tightened, as well as routing the wires separately from other wires.

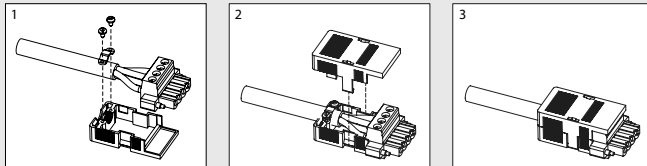

### **WARNING - PROTECTIVE FUSE**

It must be possible to disconnect manually from the power supply. Ensure compliance to national installation regulations. Replacing the internal fuse must only be performed by Westermo qualified personell.



### **WARNING - REDUCE THE RISK OF FIRE**

To reduce the risk of fire, use only telecommunication line cords with a cable diameter of AWG 26 or larger. Regarding power cable dimensions, see Interface Specifications.



### **CAUTION - CLASS 1 LASER PRODUCT**

Do not look directly into a fibre optical port or any connected fibre, although the product is designed to meet the Class 1 Laser regulations and complies with 21 CFR 1040.10 and 1040.11.



### **CAUTION - HANDLING OF SFP TRANSCEIVERS**

SFP transceivers are supplied with plugs to avoid contamination inside the optical port. They are very sensitive to dust and dirt. If the fibre is disconnected from the product, the protective plugs on the transmitter/receiver must be connected. The protective plugs must be kept on during transportation. The fibre optics cables must be handled the same way.



### **CAUTION - ELECTROSTATIC DISCHARGE (ESD)**

Prevent electrostatic discharge damages to internal electronic parts by discharging your body to a grounding point (e.g. use a wrist strap).

## Care recommendations

Follow the care recommendations below to maintain full operation of product and to fulfill the warranty obligations:

- Do not drop, knock or shake the product. Rough handling above the specification may cause damage to internal circuit boards.
- Use a dry or slightly water-damp cloth to clean the product. Do not use harsh chemicals, cleaning solvents or strong detergents.
- Do not paint the product. Paint can clog the product and prevent proper operation.

If the product is used in a manner not according to specification, the protection provided by the equipment may be impaired.

If the product is not working properly, contact the place of purchase, nearest Westermo distributor office or Westermo technical support.

## Cleaning of the optical connectors

In the event of contamination, the optical connectors should only be cleaned by the use of recommended cleaning fluids and correct cleaning equipment.

Recommended cleaning fluids:

- Methyl-, ethyl-, isopropyl- or isobutyl-alcohol
- Hexane
- Naphtha

## Product disposal



This symbol means that the product shall not be treated as unsorted municipal waste when disposing of it. It needs to be handed over to an applicable collection point for recycling electrical and electronic equipment.

By ensuring this product is disposed of correctly, you will help to reduce hazardous substances and prevent potential negative consequences to both environment and human health, which could be caused by inappropriate disposal.

## Declaration of Conformity

Hereby, Westermo declares that this product is in compliance with applicable EU directives and UK legislations. The full declaration of conformity and other detailed information is available at [www.westermo.com/support/product-support](http://www.westermo.com/support/product-support).





## Agency approvals and standards compliance

Art.no	Model	Type	Approval/compliance
3641-4020	RFIR-127-F4G-T7G-DC	EMC	EN 50121-4, Railway applications – Electromagnetic compatibility – Emission and immunity of the signalling and telecommunications apparatus
3641-4030	RFIR-127-F4G-T7G-AC		
3641-4005	RFIR-219-F4G-T7G-DC		
3641-4015	RFIR-219-F4G-T7G-AC		
3641-4025	RFIR-227-F4G-T7G-DC		
3641-4035	RFIR-227-F4G-T7G-AC	Safety	EN 61000-6-1, Electromagnetic compatibility – Immunity for residential environments EN 61000-6-2, Electromagnetic compatibility – Immunity for industrial environments EN 61000-6-4, Electromagnetic compatibility – Emission for industrial environments

### FCC Part 15.105

#### Notice:

This equipment has been tested and found to comply with the limits for a Class A digital device, pursuant to Part 15 of the FCC Rules. These limits are designed to provide reasonable protection against harmful interference when the equipment is operated in a commercial environment. This equipment generates, uses, and can radiate radio frequency energy and, if not installed and used in accordance with the instruction manual, may cause harmful interference to radio communications. Operation of this equipment in a residential area is likely to cause harmful interference in which case the user will be required to correct the interference at his own expense.

### EN/IEC 62368-1

#### Notice:

This product has been tested and found compliant to EN/IEC 62368-1, Safety for Communication Technology. In accordance with the definitions of the standard, this product shall be handled by skilled personell. Energy source classifications are according to following:

Electrical energy source	Power port	ES1 (DC model) ES3 (AC model)
	Ethernet port	ES1, TNV-1
	I/O port	ES1
Power source	Power port	PS3
Thermal energy source	Enclosure	TS1
Mechanical energy source	Enclosure	MS1
Radiation energy source	SFP	RS1

# Safety control drawing

Position	Direction/description	Input/output values
1	In/out / BI_DA+	Per port: $U = \pm 1\text{ V}$ (4V/us) $I = \pm 20\text{ mA}$ Data rate: 10/100/1000 Mbit/s
2	In/out / BI_DA-	
3	In/out / BI_DB+	
4	In/out / BI_DC+	
5	In/out / BI_DC-	
6	In/out / BI_DB-	
7	In/out / BI_DD+	
8	In/out / BI_DD-	
Shield	Functional earth	

Galvanically isolated via signal transformers and capacitively isolated to GND/Functional earth through a 2kV 1000pF capacitor.  
See user manual for proven transient protection.

Position	Direction/description	Output values
1	Out / VBUS	$U_{\text{out}} = 5\text{ VDC max}$ $I_{\text{out}} = 500\text{ mA max}$
2	In/out / D-	
3	In/out / D+	
4	GND	
Shield	Functional earth	

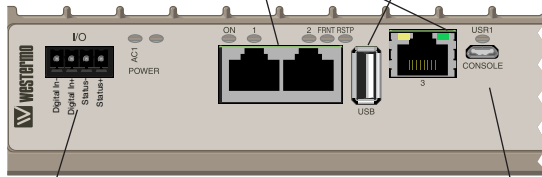

Position	Direction/description	Input/Output values
Status+	IO / Status +	$U_{\text{in}} = 60\text{ VDC max}$
Status--	IO / Status -	$I_{\text{in}} = 80\text{ mA max}$
Digital In+	IO / Digital in +	$U_{\text{in}} = 60\text{ VDC max}$
Digital In-	IO / Digital in -	$I_{\text{in}} = 2.9\text{ mA max}$

Position	Direction/description	Output values
1	In / VBUS	$U = 5\text{ VDC max}$ $I = 100\text{ mA max}$
2	In/out / D-	
3	In/out / D+	
4	Not connected	
5	Functional earth	

## DC Power supply

Direction/description	Input values
In / +DC1	$U_{\text{in}} = (16 - 60)\text{ VDC}$ $I_{\text{in}} = 2.0\text{ A}@16\text{ VDC}^*$ $P_{\text{in}} = 32\text{ W}@16\text{ VDC}^*$
In / +DC2	
In / COM	
In / COM	

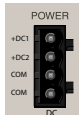

\* RFR-227-T7G-F4G-DC  
 \*\* RFR-227-T7G-F4G-AC

## AC Power supply

Direction/description	Input values
In / P	$U_{\text{in}} = (100-240)\text{ VAC},$ 50-60 Hz $I_{\text{in}} = 360\text{ mA}@100\text{ VAC}^{**}$
In / N	
In / NC	
In / $\text{th}$	

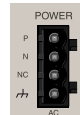

Degree of protection:	IP40
Ambient temperature:	-40 °C to +70 °C (DC), -40 °C to +55 °C (AC)

## Safety control drawing

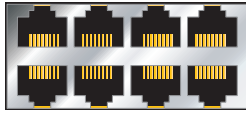

Position	Direction* / description	Input/output values
1	In/out / TD+	Per port: $U = \pm 1 \text{ V}$ (4V/us) $I = \pm 20 \text{ mA}$ Data rate: 10/100 Mbit/s
2	In/out / TD-	
3	In/out / RD+	
4	Not connected	
5	Not connected	
6	In/out / RD-	
7	Not connected	
8	Not connected	
Shield	Functional earth	

Galvanically isolated via signal transformers and capacitively isolated to functional earth through a 2kV 1000pF capacitor. See user manual for proven transient protection.



Position	Direction* / description	Input/output values
Rx	In / Receive port	Max 5 dBm
Tx	Out / Transmit port	

Position	Direction* / description	Input/output values
1	In/out / BI_DA+	Per port: $U = \pm 1 \text{ V}$ (4V/us) $I = \pm 20 \text{ mA}$ Data rate: 100/1000 Mbit/s
2	In/out / BI_DA-	
3	In/out / BI_DB+	
4	In/out / BI_DC+	
5	In/out / BI_DC-	
6	In/out / BI_DB-	
7	In/out / BI_DD+	
8	In/out / BI_DD-	
Shield	Functional earth	

Galvanically isolated via signal transformers and capacitively isolated to functional earth through a 2kV 1000pF capacitor. See user manual for proven transient protection.

\* Direction relative this unit!

## Type tests and environmental conditions

Phenomena	Test	Description	Test levels
ESD	EN 61000-4-2	Enclosure contact	± 6 kV
		Enclosure air	± 8 kV
RF field AM modulated	IEC 61000-4-3	Enclosure	20 V/m 80% AM (1 kHz), 80 – 2700 MHz 10 V/m 80% AM, 1kHz sine, 2700 – 6000 MHz
Fast transient	EN 61000-4-4	Signal ports	± 2 kV
		Power ports	± 2 kV
Surge	EN 61000-4-5	Signal ports	± 2 kV line to earth, ± 1 kV line to line
		Power ports	± 2 kV line to earth, ± 2 kV line to line (AC models) ± 2 kV line to earth, ± 1 kV line to line (DC models)
RF conducted	EN 61000-4-6	Signal ports	10 V 80% AM (1 kHz), 0.15 – 80 MHz
		Power ports	10 V 80% AM (1 kHz), 0.15 – 80 MHz
Power frequency magnetic field	EN 61000-4-8	Enclosure	300 A/m 0, 16.7, 50, 60 Hz
Pulse magnetic field	EN 61000-4-9	Enclosure	300 A/m
Radiated emission	CISPR 16-2-3	Enclosure	Class A
	ANSI C63.4 (FCC part 15)	Enclosure	Class B, 30 – 6500 MHz
Conducted emission	CISPR 16-2-1	AC and DC power ports Telecommunication ports Class B	EN 61000-6-4
	FCC part 15	AC and DC power ports	Class B
Dielectric strength	UL 60950-1 EN/IEC 62368-1	Signal port to other isolated ports	1.5 kVrms 50 Hz 1 min
		Power port to other isolated ports	1.5 kVrms 50 Hz 1 min
Temperature	EN 60068-2-1 EN 60068-2-2	Operating	-40 to +70°C (DC models) -40 to +55°C (AC models)
		Storage & Transport	-40 to +85°C (all models)
Humidity	EN 60068-2-30	Operating	5 to 95% relative humidity
		Storage & Transport	5 to 95% relative humidity
Altitude		Operating	2 000 m / 70 kPa
Service life		Operating	10 years
Vibration	IEC 60068-2-6	Operating	7.5 mm, 5 – 8 Hz 2 g, 8 – 500 Hz (19" rack mounting according to IEC 60297, DIN 41494)
Shock	IEC 60068-2-27	Operating	15 g, 11 ms (19" rack mounting according to IEC 60297, DIN 41494)
Enclosure	UL 94	Aluminium / Zink	Flammability class V-0 (all models)

## Description

The RFIR (RedFox Industrial Rack) is a high performance industrial Ethernet switch designed for high network traffic applications. Various port configurations are available that can be further customized with SFP transceivers. RFIR is powered by the Westermo WeOS network operating system.

RFIR is designed for 19" cabinet according to ETSI standard making it suitable for use in control room networks as well as for cabinets installed along railway trackside or maritime installations. RFIR is designed to run efficiently from an AC or DC power supply, the unit is also equipped with configurable I/O fault contact that make it ideal for easy installation and monitoring in industrial applications.

## RedFox Industrial Rack models

Westermo article number	Denomination	Description
3641-4020	RFIR-127-F4G-T7G-DC	16 x 10/100 Mbit/s, Ethernet TX, RJ-45 7 x 10/100/1000 Mbit/s, Ethernet TX, RJ-45 4 x 100/1000 Mbit/s, pluggable connections transceivers supported, Ethernet FX or TX SFP DC power supply
3641-4030	RFIR-127-F4G-T7G-AC	16 x 10/100 Mbit/s, Ethernet TX, RJ-45 7 x 10/100/1000 Mbit/s, Ethernet TX, RJ-45 4 x 100/1000 Mbit/s, pluggable connections transceivers supported, Ethernet FX or TX SFP AC power supply
3641-4005	RFIR-219-F4G-T7G-DC	8 x 10/100 Mbit/s, Ethernet TX, RJ-45 7 x 10/100/1000 Mbit/s, Gigabit Ethernet TX, RJ-45 4 x 100/1000 Mbit/s, pluggable connections transceivers supported, Ethernet FX or TX SFP DC power supply
3641-4015	RFIR-219-F4G-T7G-AC	8 x 10/100 Mbit/s, Ethernet TX, RJ-45 7 x 10/100/1000 Mbit/s, Gigabit Ethernet TX, RJ-45 4 x 100/1000 Mbit/s, pluggable connections transceivers supported, Ethernet FX or TX SFP AC power supply
3641-4025	RFIR-227-F4G-T7G-DC	16 x 10/100 Mbit/s, Ethernet TX, RJ-45 7 x 10/100/1000 Mbit/s, Gigabit Ethernet TX, RJ-45 4 x 100/1000 Mbit/s, pluggable connections transceivers supported, Ethernet FX or TX SFP DC power supply
3641-4035	RFIR-227-F4G-T7G-AC	16 x 10/100 Mbit/s, Ethernet TX, RJ-45 7 x 10/100/1000 Mbit/s, Gigabit Ethernet TX, RJ-45 4 x 100/1000 Mbit/s, pluggable connections transceivers supported, Ethernet FX or TX SFP AC power supply

# Housing

## Description

The RedFox Industrial Rack is designed for installation in 19" rack solutions according to ETSI standard with a shallow depth of 240 mm. RFIR can also be wall mounted as an installation option.

Port number RFIR-219-F4G-T7G DC or AC



Port number all other models

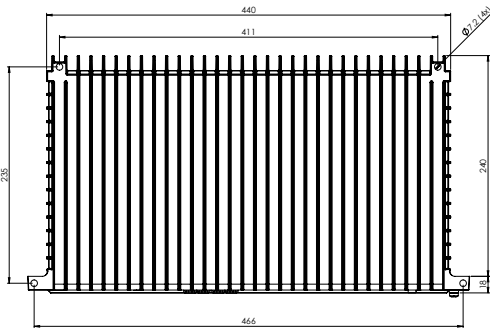
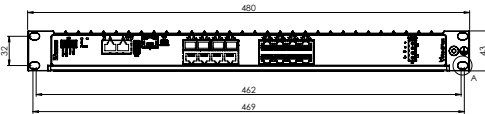

## Specification

Dimension W x H x D	480 x 43 x 258 mm 18.9 x 1.66 x 10.16"
Weight	3.8 kg
Degree of protection	IP40 according to EN 60529
Cooling	Convection
Mounting	19" rack or wall-mounted

## Interface specifications

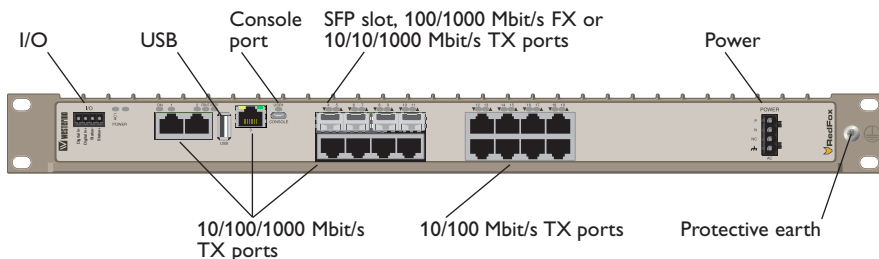

## Power interface specifications

DC power 	4-position	Product marking	Direction	Description
	No. 1	+DC1	Input	Supply voltage input DC1
	No. 2	+DC2	Input	Supply voltage input DC2
	No. 3	-COM	Input	Common
	No. 4	-COM	Input	Common

### AC power

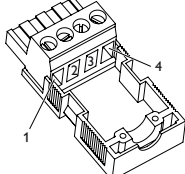
	4-position	Product marking	Direction	Description
	No. 1	P	Input	Power
	No. 2	N	Input	Neutral
	No. 3	NC	Input	No connection
	No. 4	$\perp$	Input	Functional earth



### WARNING - PREVENT ACCESS TO HAZARDOUS VOLTAGE CABLE

Apply the protective cap (delivered with the AC product) on the power cable, according to the illustrated steps below. To prevent accidentally pulling out wires, make sure the power cable and the wires are firmly attached to the protective cap.

For screw connectors, make sure the screws are properly tightened, as well as routing the wires separately from other wires.

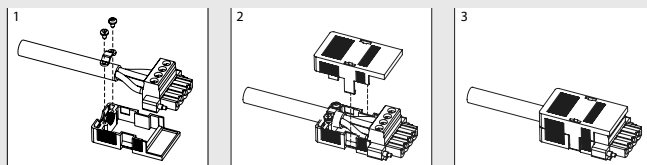

<b>Power</b>		
Rated voltage	AC models	100 to 240 VAC, 50-60 Hz
	DC models	20 to 48 VDC
Operating voltage	AC models	90 to 264 VAC, 47-63 Hz
	DC models	16 to 60 VDC
Maximum nominal current consumption	RFIR-127-F4G-T7G-DC	1.0 (1.2*) A @ 24 VDC 0.47 (0.54*) A @ 48 VDC
	RFIR-219-F4G-T7G-DC	0.93 (1.12*) A @ 20 VDC 0.38 (0.45*) A @ 48 VDC
	RFIR-227-F4G-T7G-DC	1.0 (1.2*) A @ 24 VDC 0.47 (0.54*) A @ 48 VDC
	RFIR-127-F4G-T7G-AC	380 mA @ 100 VAC 50 Hz 240 mA @ 240 VAC 60 Hz
	RFIR-219-F4G-T7G-AC	350 mA @ 100 VAC 50 Hz 210 mA @ 240 VAC 60 Hz
	RFIR-227-F4G-T7G-AC	380 mA @ 100 VAC 50 Hz 240 mA @ 240 VAC 60 Hz
Fuse rating <i>Component: U3, U18</i>	All models	4A(T)***
Inrush current	DC models	25 mA <sup>2</sup> @ 24 VDC 165 mA <sup>2</sup> @ 48 VDC
	AC models	75 mA <sup>2</sup> @ 110 VAC 340 mA <sup>2</sup> @ 230 VAC
Startup current**	All models	2x nominal current
Rated frequency	AC models	50/60 Hz
	DC models	DC
Polarity	AC models	Not applicable
	DC models	Reverse polarity protected
Redundant power input	AC models	No
	DC models	Yes
Isolation to		All other
Connection		Detachable screw terminal
Connector size	All models	0.2 – 2.5 mm <sup>2</sup> (AWG 24 – 12)
Shielded cable		Not required

\* With 500mA USB load

\*\* External supply current capability for proper start-up

\*\*\* Denote time-delay fuse



## Console



### Connection to console port

The console port can be used to connect to the CLI (Command Line Interface). The console connector is a micro USB cable that connects to a FTDI FT232R USB to serial converter internally. For drivers please see [www.ftdichip.com](http://www.ftdichip.com) and download the appropriate VCP driver.

Console	
Electrical specification	USB 2.0 device interface
Data rate	High speed 480mbit/s
Circuit type	SE LV
Maximum supply current	100 mA
Isolation to	All other except USB
Galvanic connection to	USB
Connection	USB Micro-B connector in device mode

## USB



USB	
Electrical specification	USB 2.0 host interface
Data rate	High speed 480mbit/s
Circuit type	SELV
Maximum supply current	500 mA
Isolation to	All other except Console
Connection	USB receptacle connector type A
Conductive housing	Yes

# Network ports

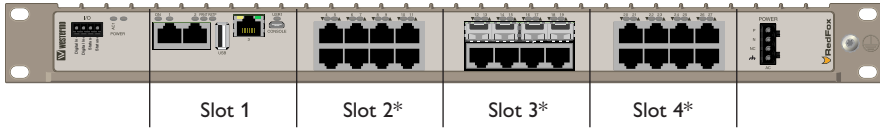

<b>RFIR-219-F4G-T7G DC and AC</b>	
<b>Slot 1</b>	
1	10/100/1000 Mbit/s, TX port
2	10/100/1000 Mbit/s, TX port
3	10/100/1000 Mbit/s, TX port
<b>Slot 2</b>	
4	10/100/1000 Mbit/s, TX port
5	SFP slot
6	10/100/1000 Mbit/s, TX port
7	SFP slot
8	10/100/1000 Mbit/s, TX port
9	SFP slot
10	10/100/1000 Mbit/s, TX port
11	SFP slot
<b>Slot 3</b>	
12	10/100 Mbit/s, TX port
13	10/100 Mbit/s, TX port
14	10/100 Mbit/s, TX port
15	10/100 Mbit/s, TX port
16	10/100 Mbit/s, TX port
17	10/100 Mbit/s, TX port
18	10/100 Mbit/s, TX port
19	10/100 Mbit/s, TX port

<b>RFIR-127-F4G-T7G DC and AC</b>	
<b>RFIR-227-F4G-T7G DC and AC</b>	
<b>Slot 1</b>	
1	10/100/1000 Mbit/s, TX port
2	10/100/1000 Mbit/s, TX port
3	10/100/1000 Mbit/s, TX port
<b>Slot 2</b>	
4	10/100 Mbit/s, TX port
5	10/100 Mbit/s, TX port
6	10/100 Mbit/s, TX port
7	10/100 Mbit/s, TX port
8	10/100 Mbit/s, TX port
9	10/100 Mbit/s, TX port
10	10/100 Mbit/s, TX port
11	10/100 Mbit/s, TX port
<b>Slot 3</b>	
12	10/100/1000 Mbit/s, TX port
13	SFP slot
14	10/100/1000 Mbit/s, TX port
15	SFP slot
16	10/100/1000 Mbit/s, TX port
17	SFP slot
18	10/100/1000 Mbit/s, TX port
19	SFP slot
<b>Slot 4</b>	
20	10/100 Mbit/s, TX port
21	10/100 Mbit/s, TX port
22	10/100 Mbit/s, TX port
23	10/100 Mbit/s, TX port
24	10/100 Mbit/s, TX port
25	10/100 Mbit/s, TX port
26	10/100 Mbit/s, TX port
27	10/100 Mbit/s, TX port

\* Network ports at slot 2 and slot 3 differ between the different RFIR models. Slot 4 is only available in model RFIR-227-F4G-T7G DC and AC.

## 10/100(/1000) Mbit/s, TX ports



Ethernet TX	
Electrical specification	IEEE std 802.3. 2005 Edition
Data rate	10 Mbit/s, 100 Mbit/s, (1000 Mbit/s), manual or auto
Duplex	Full or half, manual or auto
Circuit type	TNV-1
Transmission range	Up to 150 m with CAT5e cable or better
Isolation to	All other
Connection	RJ-45 auto MDI/MDI-X
Shielded cable	Not required, except when installed in Railway applications as signalling and telecommunications apparatus and located close to rails*
Conductive housing	Yes

\* **NOTE!** Railway installation close to the rails.

To minimise the risk of interference, a shielded cable is recommended when the cable is located inside 3 m boundary to the rails and connected to this port.

The cable shield should be properly connected (360°) to an earthing point within 1 m from this port. This earthing point should have a low impedance connection to the conductive enclosure of the apparatus cabinet, or similar, where the unit is built-in. This conductive enclosure should be connected to the earthing system of an installation and may be directly connected to the functional earth. Refer also to "Safety" section.

10/100/1000 Mbit/s, TX		
Position	Direction*	Description
1	In/Out	BI_DA+
2	In/Out	BI_DA-
3	In/Out	BI_DB+
4	In/Out	BI_DC+
5	In/Out	BI_DC-
6	In/Out	BI_DB-
7	In/Out	BI_DD+
8	In/Out	BI_DD-
Shield	In/Out	Connected to Functional earth

\* Direction relative this unit.

10/100 Mbit/s, TX		
Position	Direction*	Description
1	In/Out	TD+
2	In/Out	TD-
3	In/Out	RD+
4	In/Out	Not connected
5	In/Out	Not connected
6	In/Out	RD-
7	In/Out	Not connected
8	In/Out	Not connected
Shield	In/Out	Connected to Functional earth

\* Direction relative this unit.

## SFP slot

Each SFP slot can hold one SFP transceiver for copper or fibre cable. Fibre transceivers distances range from 550 m (0.34 mi) to 120 km (74.6 mi). For supported transceivers, see SFP data sheet.



Position	Direction*	Description
Rx	In	Receive port
Tx	Out	Transmit port

\* Direction relative this unit.

SFP ports	
Optical/Electrical specification	IEEE std 802.3 2005 Edition
Data rate	10, 100 or 1000 Mbit/s*
Duplex	Full or half, manual or auto
Transmission range	Depending on transceiver
Connection	SFP slot holding fibre transceiver or copper transceiver

\* 100 Mbit/s or 1000 Mbit/s transceiver supported.

## I/O connection

	Product marking	Direction	Description
Digital In- —	Digital in -	Input	Digital in -
Digital In+ —	Digital in +	Input	Digital in +
Status- —	Status -	Output	Alarm relay (status) contact
Status+ —	Status +	Output	Alarm relay (status) contact

The Status output is a potential free, opto-isolated normally closed solid-state relay. This can be configured to monitor various alarm events within the RFIR unit, see WeOS Management Guide. An external load in series is required for current ratings, see Interface specification section.

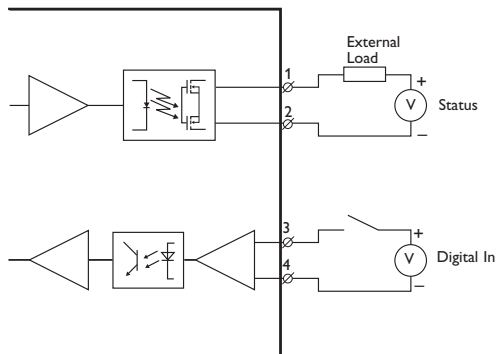

The Digital in is an opto-isolated digital input which can be used to monitor external events. For voltage/current ratings, see Interface Specification section:

<b>IO / Relay output</b>	
Connect resistance	30 Ω
Isolation to	All other
Connection	Detachable screw terminal
Connector size	0.2 – 2.5 mm <sup>2</sup> (AWG 24 – 12)
Maximum voltage/current	60 VDC / 80 mA
<b>IO / Digital input</b>	
Voltage levels	$V_{ih} > 8V$ $V_{il} < 5V$ , $I_{in} = 2.9mA$ @60V
Isolation to	All other
Connection	Detachable screw terminal
Connector size	0.2 – 2.5 mm <sup>2</sup> (AWG 24 – 12)
Maximum voltage	60 VDC

## LED indicators Power/CPU

LED	Status	Description
ON	OFF	Unit has no power.
	GREEN	All OK, no alarm condition.
	RED	Alarm condition, or until unit has started up. (Alarm conditions are configurable, see "WeOS Management Guide").
	BLINK	Location indicator ("Here I am!"). Activated when connected to IPConfig Tool, or upon request from Web or CLI.
DC1	OFF	Unit has no power.
	GREEN	Power OK on DC1.
	RED	+DC1 input voltage is below operating voltage limit
DC2	OFF	Unit has no power.
	GREEN	Power OK on DC2.
	RED	+DC2 input voltage is below operating voltage limit
AC1	OFF	Unit has no power
	GREEN	Power OK on AC1
FRNT	OFF	FRNT disabled.
	GREEN	FRNT OK.
	RED	FRNT Error.
	BLINK	Unit configured as FRNT Focal Point.
RSTP	OFF	RSTP disabled.
	GREEN	RSTP enabled.
	BLINK	Unit elected as RSTP/STP root switch.
USR1	<i>Configurable, see WeOS Management Guide</i>	
TX/FX ports	OFF	No link.
	GREEN	Link established.
	GREEN FLASH	Data traffic indication.
	YELLOW	Port alarm and no link. Or if FRNT or RSTP mode, port is blocked.

## SFP Transceivers

The unit supports Westermo labelled transceivers only. See Westermo's modular transceivers datasheets 100 Mbit and 1 Gbit for supported SFP transceivers for the RedFox series. See Transceiver User Guide "6100-0000" for transceiver handling instructions.

## Mounting

This unit can either be rackmounted or wallmounted, see figures below.

### Rackmounting

The unit can be mounted in all directions inside a 19" apparatus cabinet. Use M6x25 or 1/4"x1" screws.

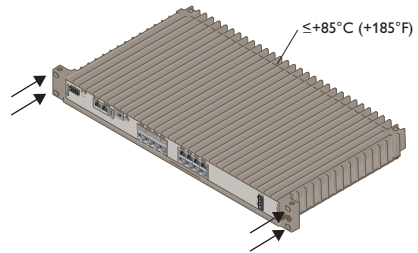

### Wallmounting

The unit can also be wallmounted in all directions. Use maximum  $\text{Ø}6,4$  mm or 1/4" screws.

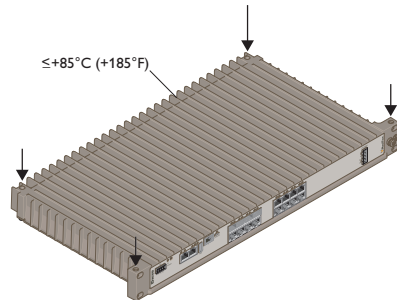

## Cooling

This unit uses convection cooling. To avoid obstructing the airflow around the unit, follow the spacing recommendations (see Cooling section). For mounting in 19" apparatus cabinet without forced ventilation, a minimal spacing of 1U according to IEC 60297 or 45 mm (1.75") above/below is recommended. With forced ventilation, no minimal spacing is required as long as the temperature of the rear cooling plates does not exceed +85°C (+185°F).

For wallmounting in an area without forced ventilation, a minimum spacing of 45 mm (1.75") above/below and 10 mm (0.4") left/right is recommended. For areas with forced ventilation, no minimal spacing is required as long as the temperature of the rear cooling plates does not exceed +85°C (+185°F).

## Earth connection

For correct function, the ground connection on the unit needs to be properly connected to a solid ground. See the figure below.

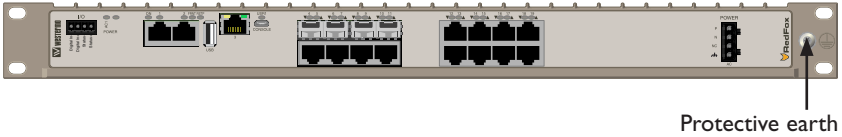

# WESTERMO

Westermo • Metallverksgatan 6, SE-721 30 Västerås, Sweden

Tel +46 16 42 80 00 Fax +46 16 42 80 01

E-mail: [info@westermo.com](mailto:info@westermo.com)

[www.westermo.com](http://www.westermo.com)