

CyBox RT 2-A

AUTOMOTIVE WIRELESS ROUTER WITH LTE CAT-6 AND WI-FI



INSTALLATION MANUAL

Revision: **2.0** | Date: **16.04.2024**

DISCLAIMER

Copyright

© 2024 Westermo Eltec GmbH. The information, data, and figures in this document including respective references have been verified and found to be legitimate. In particular in the event of error they may, therefore, be changed at any time without prior notice. The complete risk inherent in the utilization of this document or in the results of its utilization shall be with the user; to this end, Westermo Eltec GmbH shall not accept any liability. Regardless of the applicability of respective copyrights, no portion of this document shall be copied, forwarded or stored in a data reception system or entered into such systems without the express prior written consent of Westermo Eltec GmbH, regardless of how such acts are performed and what system is used (electronic, mechanic, photocopying, recording, etc.). All product and company names are registered trademarks of the respective companies.

Our General Business, Delivery, Offer, and Payment Terms and Conditions shall otherwise apply.

SAFETY INFORMATION

Electrical safety

	<p>WARNING</p> <p>The device can be operated with voltages up to 32 V DC. Incorrect handling risks causing a fatal electrical shock.</p> <p>Before connecting the power supply, connect the device to protective earth.</p>
---	--

General advice

- Only qualified personnel is allowed to install, operate and maintain the devices.
- Please take safety precautions against electrostatic discharge (ESD).
- Access to the devices may only be granted to qualified personnel.
- To prevent the risk of electric shock, turn off the external power supply and remove the power supply cable from the electrical outlet before handling or disassembling the system.
- When adding or removing devices to or from the system, ensure that the power cables for the devices are unplugged before the signal cables are connected.
- Make sure that your power supply is set to the correct voltage in your area. If you are not sure about the voltage of the electrical outlet you are using, contact your local power company.
- If the power supply is broken, do not try to fix it by yourself. Contact a qualified service technician or your retailer.

Operation safety

	<p>WARNING</p> <p>The device can become very hot during operation (> 80 ° C). Make sure it is protected from accidental contact. The device must be installed so that it is not accessible to children.</p> <p>To prevent burns, switch off the device and allow to cool down for half an hour before disassembling or working on it.</p>
---	---

- Before installing the device and connecting cables to it, carefully read the related manuals.
- Before using the device, make sure all cables are correctly connected and the power cables are not damaged. If you detect any damage, contact your dealer immediately.
- Avoid dust, humidity, and temperature extremes. Do not place the product in any area where it may become wet.
- Place the product on a stable surface.
- If you encounter technical problems with the product, contact a qualified service technician or your retailer.

Radio Frequency Exposure Statement

At least 20 cm separation distance between the antenna and the user's body must be maintained at all times.

RECYCLING

Please recycle packaging environmentally friendly:



Packaging materials are recyclable. Please do not dispose packaging into domestic waste but recycle it.

Please recycle old or redundant devices environmentally friendly:



Old devices contain valuable recyclable materials that should be reutilized. Therefore please dispose old devices at collection points which are suitable.

EU DECLARATION OF CONFORMITY



Westermo Eltec GmbH herewith declares that the device is compliant to the basic requirements of the directive 2014/53/EU. The full text of the EU declaration of conformity is available in the Download Center at www.eltec.com.

CONTACT

Westermo Eltec GmbH
Galileo-Galilei-Straße 11
55129 Mainz
Germany

Fon +49 6131 918 100

Email info.eltec@westermo.com

www www.eltec.com | www.westermo.com

CONTENTS

1	ABOUT THIS DOCUMENT	1
2	OVERVIEW	2
2.1	Product	2
3	HARDWARE	3
3.1	Device Connectors	3
3.1.1	Power Supply Connectors	3
3.1.2	Ethernet Interfaces	3
3.1.3	CAN Interfaces	4
3.1.4	QLS Antenna Connectors	5
3.1.5	FAKRA Antenna Connectors	6
3.1.6	SMA / RP-SMA Antenna Connectors	6
3.2	Power Supply	7
3.2.1	Power Input	7
3.3	Front and Back Panel Distribution	8
3.3.1	Front Panel Service Cover	8
3.3.2	Back Panel Distribution	9
3.3.3	Assignment Front Panel Labelling - Software	9
3.4	LED Indicators	10
3.4.1	Power LED Status	10
3.4.2	Status LED	10
3.4.3	Module LEDs	10
3.4.4	LAN LEDs (100 M 1000 M) Status	10
3.5	Reset Switch	11
3.6	SIM Cards	11
4	MOUNTING	12
4.1	Connecting an Earthing Cable	13
4.2	Electrical Connection	13

LIST OF TABLES

Table 1	Pin Assignment of Power Supply Connector (PWR)	3
Table 2	Pin Assignment of RJ45 Ethernet Connectors (LAN 1..5)	3
Table 3	Pin Assignment of CAN Connectors	4
Table 4	Remove QLS / QMA Jack	5
Table 5	FAKRA Mating Connectors	6
Table 6	SMA / RP-SMA Mating Connectors	6
Table 7	SMA / RP-SMA Connectors	7
Table 8	Front Panel Service Cover	8
Table 9	Back Panel Description	9
Table 10	Power LED Status	10
Table 11	Status LED	10
Table 12	Module LEDs	10
Table 13	LAN LEDs Status	10
Table 14	Reset Switch Behavior	11

LIST OF FIGURES

Figure 1	Picture of CyBox RT 2-A - Front	2
Figure 2	Picture of CyBox RT 2-A - Back	2
Figure 3	Front Panel Overview	8
Figure 4	Back Panel Overview	9
Figure 5	SIM Slot Assignment per Modem	11
Figure 6	Dimensions of the Housing	12
Figure 7	Earth Cable Mounting on Earth Stud	13

1 ABOUT THIS DOCUMENT

This installation manual is intended only for system developers and integrators; it is not intended for end users.

It describes the hardware functions of the product, connection of peripheral devices and integration into a system. Additional information on special applications and the configuration of the product is available in a separate configuration manual which can be downloaded from the Download Center at www.eltec.com.

2 OVERVIEW

2.1 PRODUCT

This installation manual comprises all information to set-up the following product.



Figure 1 **Picture of CyBox RT 2-A - Front**



Figure 2 **Picture of CyBox RT 2-A - Back**

3 HARDWARE

3.1 DEVICE CONNECTORS

3.1.1 POWER SUPPLY CONNECTORS

The electrical power can be supplied to the device using the MSTB 2.5/ 3 GF pcb header, labeled PWR.

The mating connector from Phoenix Contact is MSTB 2,5/ 3-STF with order number 1786844 or alternatively Phoenix Contact MSTB 2,5/ 3-STF-5,08 with order number 1777992.

Table 1 shows the pin assignment of the power supply connector.

	PIN	SIGNAL NAME	DESCRIPTION
	1	+VIN	Supply voltage, positive terminal
	2	-VIN	Supply voltage, negative terminal
	3	Ignition	Ignition (power on) signal

Table 1 **Pin Assignment of Power Supply Connector (PWR)**

3.1.2 ETHERNET INTERFACES

The LAN ports of the CyBox RT 2-A are utilizing RJ45 connectors with the pin assignment as shown in Table 2 below. Mating connectors are available from several manufacturers.

The mating connector is a standard RJ45 connector.

	PIN	SIGNAL NAME	DESCRIPTION
	1	D1+	First data line plus
	2	D1-	First data line minus
	3	D2+	Second data line plus
	4	D3+	Third data line plus
	5	D3-	Third data line minus
	6	D2-	Second data line minus
	7	D4+	Fourth data line plus
	8	D4-	Fourth data line minus

Table 2 **Pin Assignment of RJ45 Ethernet Connectors (LAN 1..5)**

3.1.3 CAN INTERFACES

The CAN interfaces of the CyBox RT 2-A are utilizing D-Sub 9 connectors. Two CAN connectors are available (in and out) to connect one CAN device only. Both CAN connectors provide the same CAN signals so that a CAN-typical bus topology connection can be realized.

The pin assignment is shown in Table 3 below. Mating connectors are available from several manufacturers.

The mating connector is a standard D-Sub 9 connector male and female.

	PIN	SIGNAL NAME	DESCRIPTION
	1	NC	Not connected
	2	CAN-	Data -
	3	GND	Signal ground
	4	NC	Not connected
	5	NC	Not connected
	6	NC	Not connected
	7	CAN+	Data +
	8	NC	Not connected
	9	NC	Not connected

Table 3 **Pin Assignment of CAN Connectors**

3.1.4 QLS ANTENNA CONNECTORS

The QLS antenna connectors are located at the the backside of the device. All connectors are labeled for each radio, modem and GNSS interface. Their functionalities depend on the CyBox model (see 3.3.3 Assignment Front Panel Labelling - Software).

The mating connector is a standard jack QLS or QMA connector.

When connecting an antenna to the QLS connector, make sure that you hear a 'click' sound confirming proper mounting.

To remove an antenna, it must be gently pulled from the basis of the connector with one hand, while the other hand is holding the antenna. Alternatively, a screwdriver can be used as a lever arm at the basis of the antenna to facilitate the removal, as illustrated below.



Table 4 **Remove QLS / QMA Jack**

3.1.5 FAKRA ANTENNA CONNECTORS

The FAKRA antenna connectors are located at the backside of the device. All connectors are labeled for each radio, modem and GNSS interface. Their functionalities depend on the CyBox model (see 3.3.3 Assignment Front Panel Labelling - Software).

When connecting an antenna to the FAKRA connector, make sure that you hear a 'click' sound confirming proper mounting. To remove an antenna, gently push down on the top center portion of the connector with a finger and pull it away from the panel.



FUNCTIONALITY	MATING CONNECTOR	PLUG LEFT / JACK RIGHT
LTE	FAKRA jack code D	
WLAN	FAKRA jack code I	
GNSS	FAKRA jack code C	

Table 5 **FAKRA Mating Connectors**

3.1.6 SMA / RP-SMA ANTENNA CONNECTORS

The SMA / RP-SMA antenna connectors are located at the backside of the device. All connectors are labeled for each radio, modem and GNSS interface. Their functionalities depend on the CyBox model (see 3.3.3 Assignment Front Panel Labelling - Software).

When connecting an antenna to the SMA or RP-SMA connector, make sure that the connectors are fixed with sufficient force. For example, you can use an SMA torque wrench with a preset of 0.9 Nm torque.



FUNCTIONALITY	MATING CONNECTOR	VISUALLY
LTE	SMA - male	
WLAN	RP-SMA - male	
GNSS	SMA - male	

Table 6 **SMA / RP-SMA Mating Connectors**

SMA connector variety:



Table 7 **SMA / RP-SMA Connectors**

3.2 POWER SUPPLY

3.2.1 POWER INPUT

The CyBox RT 2-A can be powered by a DC power source connected to the internal power supply and I/O connector, shown in Table 1 . The nominal input voltage can vary between 12 V and 24 VDC.

3.3 FRONT AND BACK PANEL DISTRIBUTION

3.3.1 FRONT PANEL SERVICE COVER

The CyBox RT 2-A is equipped with a USB 2.0 Type A service port and 4 SIM slots, which are located behind the service cover as shown in Figure 3 and described in Table 8. The USB port can be used to attach a memory device to update the firmware or to configure the device. The service cover is secured with 2 torx screws.

Note: The USB port is a dedicated maintenance port. It is not designed to be used while the device is in operation inside rolling stock equipment.

The figure below provides an overview of the front panel.

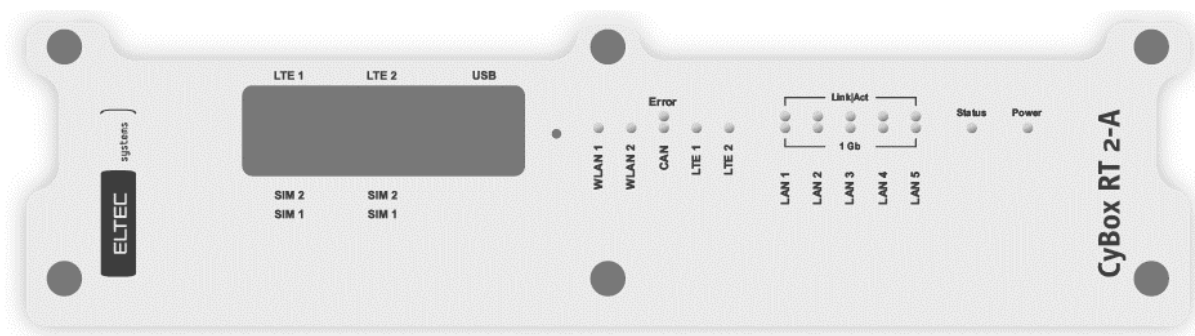

Figure 3 **Front Panel Overview**

LABEL	PORT	DESCRIPTION
LTE 1	SIM 1 / SIM 2	2 SIM slots for LTE module 1 are available. SIM slot 1 is the lower one, SIM slot 2 is the upper one as indicated on the front panel.
LTE 2	SIM 1 / SIM 2	2 SIM slots for LTE module 2 are available. SIM slot 1 is the lower one, SIM slot 2 is the upper one as indicated on the front panel.
USB	USB 2.0	Type A jack (female)

Table 8 **Front Panel Service Cover**

3.3.2 BACK PANEL DISTRIBUTION

The figure below provides an overview of the back panel.

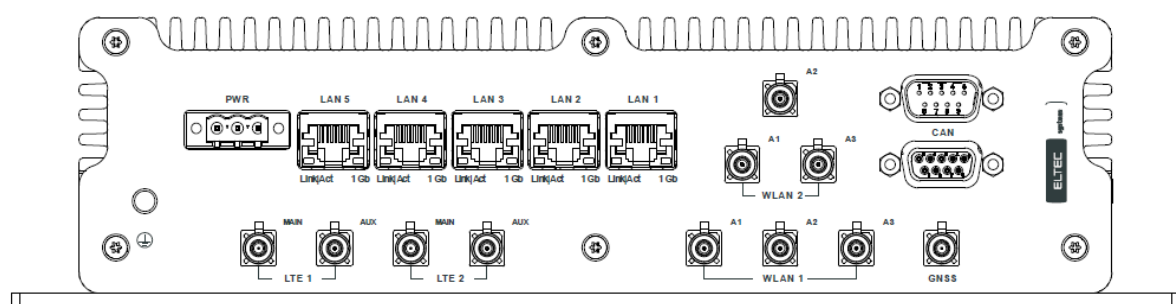

Figure 4 **Back Panel Overview**

CONNECTOR	FUNCTION	DESCRIPTION
Earthing Bolt	Shield	The earthing bolt can be found on the lower left side
PWR	System power	See Table 1 for pin assignment
LAN 1-5	1 Gb Ethernet	Triple speed Gigabit Ethernet ports
LTE 1-2	Antenna connectors	QLS / Fakra Code D / SMA antenna connectors
WLAN 1-2	Antenna connectors	QLS / Fakra Code I / RP-SMA antenna connectors
GNSS	Antenna connector	QLS / Fakra Code C / SMA antenna connector
CAN	CAN interface	1 x Min-D 9 pos. female, 1 x Min-D 9 pos. male

Table 9 **Back Panel Description**

3.3.3 ASSIGNMENT FRONT PANEL LABELLING - SOFTWARE

- The ports and LEDs "LAN 1" to "LAN 5" correspond respectively to the interfaces "eth0" to "eth4"
- The LEDs "WLAN 1" / "WLAN 2" and "LTE 1" / "LTE 2" refer to WLAN and LTE modules
- WLAN modules are called "radio" within the software
- LTE modules are called "modem" within the software
- The purpose of the antennas depends on the modules inserted in your CyBox model

3.4 LED INDICATORS

The LEDs on the front panel of CyBox RT 2-A provide quick indication of the device status.

3.4.1 POWER LED STATUS

LED COLOR	STATE	DESCRIPTION
Green	On	Device is receiving correct input power
Green	Off	Device is not powered

Table 10 **Power LED Status**

3.4.2 STATUS LED

LED COLOR	STATE	DESCRIPTION
Red	On	Error detected
Green	On	Normal operation
Green	Off	U-Boot and self testing executed
Green	Blinking	Resetting to factory settings
Red/Green	Blinking	Executing emergency system

Table 11 **Status LED**

3.4.3 MODULE LEDS

LABEL	LED COLOR	DESCRIPTION
WLAN 1	Green	On when WLAN module 1 is configured
WLAN 2	Green	On when WLAN module 2 is configured
CAN	Green	On when CAN is configured
Error	Red	On when CAN error occurred
LTE 1	Green	On when LTE module 1 is configured
LTE 2	Green	On when LTE module 2 is configured

Table 12 **Module LEDs**

3.4.4 LAN LEDS (100 M | 1000 M) STATUS

1 GBIT (GREEN)	LINK/ACT (YELLOW)	DESCRIPTION
On	On	1 Gbit link established
Off	Off	No link
On	Off	10/100 Mbit link established
Blink	Off	10/100 Mbit link established and active
Blink	On	1 Gbit link established and active

Table 13 **LAN LEDs Status**

3.5 RESET SWITCH

The CyBox RT 2-A is equipped with a hidden reset switch behind the front panel, which is located beside the service cover. The button is accessible with a straightened paper clip pushed through the little hole on the front panel. The effect of pressing the reset switch depends on the duration of its activation, as indicated in Table 14 below. The time response is valid only if the device has completely booted (after approx. 1 min). While the device is booting or executing U-Boot, pushing the button will always reset the device.

The following table describes the functions of the reset switch.

HOLD TIME	FAIL LED BEHAVIOR	ACTION
< 2 seconds	Off	Reset after release
2-5 seconds	Off	No action
> 5 seconds	Green blinking	Remove custom configuration then reset

Table 14 **Reset Switch Behavior**

3.6 SIM CARDS

The CyBox RT 2-A provides 2 SIM slots per LTE modem. Only one slot per modem can be active at any time. To install SIM cards the service cover has to be removed using a suitable torx 10 screwdriver. After installing the SIM cards the service cover must be closed and the screws tightened to a maximum torque of 0.55 Nm. The indexing of SIM slots is software dependent and can be selected via an SNMP command or using the web interface.

Note: Switching between SIM slots takes about 30 seconds, slot 1 being preselected at power up.
 If you plan to use only one SIM card for a given LTE modem it is advisable to use slot 1 to avoid slot switching delay during booting.

The drawing in Figure 5 shows the SIM slot assignment per modem.

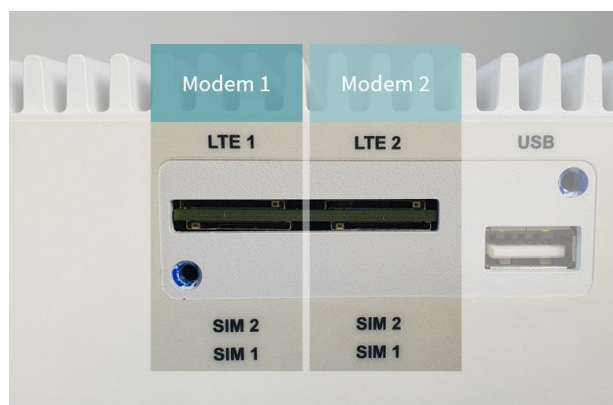

Figure 5 **SIM Slot Assignment per Modem**

Important: Do not change the SIM cards when the device is powered.

4 MOUNTING

When mounting the CyBox RT 2-A please take the following aspects into account.

- Do not install the device close to any sources of heat such as radiators or heat registers.
- Keep the device away from any liquids and avoid exposure to dripping or splashing. The protection class of the housing is IP40.
- Keep a free space of at least 150 mm around the housing to ensure adequate heat dissipation capabilities.
- For optimal heat dissipation the connectors should face down.
- The housing provides four mounting cutouts to install the device in horizontal or vertical orientation on a flat and stable surface.
- For fixation use M6 screws of sufficient length with additional M6 washers.

The drawing in Figure 6 shows the outer dimensions of the housing including the position of the mounting cutouts.

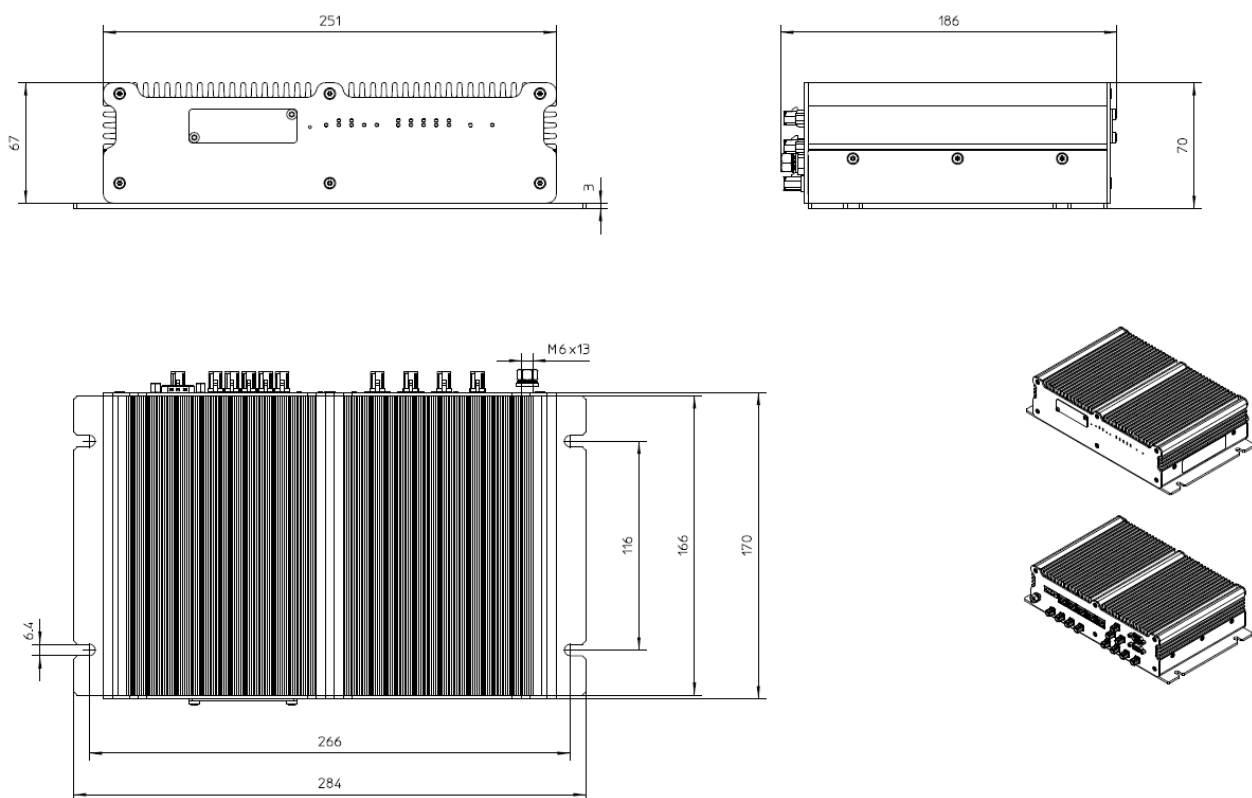

Figure 6 **Dimensions of the Housing**

4.1 CONNECTING AN EARTHING CABLE

A M6 earthing stud on the front panel of the device (also refer to Figure 3) for protective earth connection is essential for the device security. Carry out the following steps to connect an earthing cable.

- Use an earthing cable with a cross-section of at least 2.5 mm² and a wire end sleeve with eyelet suitable for a 6 mm threaded bolt.
- Mount the earth cable as shown in Figure 7.
- Fasten the cable by tightening the nut to the required torque (recommended according to EN60947-1 are 3 Nm).

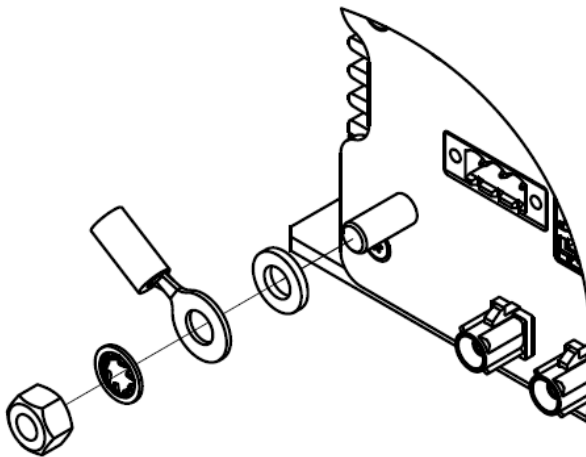

Figure 7 **Earth Cable Mounting on Earth Stud**

4.2 ELECTRICAL CONNECTION

1. Make sure the device is properly grounded.
2. Establish a connection to the network by plugging an RJ45 patch cable to one of the front panel RJ45 connectors.
3. Connect the desired number of antennas to the device. Each radio/modem can use up to three antennas for maximal performance. LTE modules are intended to be connected to two antennas and an additional GNSS antenna connector.
4. In case of using a local power supply the appropriate wiring (see Table 1) must be established to connect the power line to the device.
5. Make sure that the voltage of the power supply conforms to the voltage on the type plate.
6. Ensure that the power supply is grounded correctly and that the power cable is intact and undamaged. Do not switch on the system if there are damages on the power cable or plug.
7. Use power cables which are approved for the power supply in your country.
8. The device itself has no on/off switch, it starts as soon as it is supplied with power.