



MRD-315, MRD-415, MRD-355 & MRD-455

Industrial Cellular Router

General information

Legal information

The contents of this document are provided “as is”. Except as required by applicable law, no warranties of any kind, either express or implied, including, but not limited to, the implied warranties of merchantability and fitness for a particular purpose, are made in relation to the accuracy and reliability or contents of this document. Westermo reserves the right to revise this document or withdraw it at any time without prior notice.

Under no circumstances shall Westermo be responsible for any loss of data or income or any special, incidental, and consequential or indirect damages howsoever caused.

More information about Westermo can be found at the following Internet address:
www.westermo.com

Software tools

Related software tools are available in the folder software tools under technical support on the Westermo website.

License and copyright for included Free/Libre Open Source Software

This product includes software developed by third parties, including Free/Libre Open Source Software (FLOSS). The specific license terms and copyright associated with the software are included in each software package respectively. Please visit the product web page for more information.

Upon request, the applicable source code will be provided. A nominal fee may be charged to cover shipping and media. Please direct any source code request to your normal sales or support channel.

Management Guide

This product runs MRX Operation System. Instructions for quick start, Configuration and factory reset are found in the Management Guide at www.westermo.com.

Safety information

Before installation:

Read this manual completely and gather all information on the unit. Make sure that you understand it fully. Check that your application does not exceed the safe operating specifications for this unit.

This unit should only be installed by qualified personnel.

This unit should be built-in to an apparatus cabinet, or similar, where access is restricted to service personnel only. The power supply wiring must be sufficiently fused, and if necessary it must be possible to disconnect manually from all power supply. Ensure compliance to national installation regulations. This unit uses convection cooling. Make sure that the unit is installed such as its ambient temperature is within its specified maximum/minimum temperature.

Warning



Do not open connected unit. Hazardous voltage may occur within this unit when connected to power supply.

Prevent access to hazardous voltages by disconnecting the unit from its power supply.

Prevent damage to internal electronics from electrostatic discharges (ESD) by discharging your body to a grounding point (e.g. use of wrist strap).

Warning - Regarding radio units (RED directive)



Observe the usage limitations of radio units at filling stations, in chemical plants, in systems with explosives or potentially explosives locations.

The devices may not be used in airplanes.

Exercise particular caution near personal medical aids, such as pacemakers and hearing aids.

Never perform work on the antenna system during a thunderstorm.

The units are generally designed for normal indoor use. Do not expose them to extraordinary environmental conditions. Protect them against dust, aggressive chemical atmospheres and humidity or temperatures outside specifications.

Care recommendations

Follow the care recommendations below to maintain full operation of unit and to fulfill the warranty obligations.

- This unit must not be operating with removed covers or lids.
- Do not attempt to disassemble the unit. There are not any user serviceable parts inside.
- Do not drop, knock or shake the unit. Rough handling above the specification may cause damage to internal circuit boards.
- Do not use harsh chemicals, cleaning solvents or strong detergents to clean the unit.
- Do not expose the unit to any kind of liquids (rain, beverages, paint etc), The unit is not waterproof. Keep the unit within the specified humidity levels.
- Do not use or store the unit in dusty or dirty areas, connectors as well as other mechanical part may be damaged.

If the unit is not working properly, contact the place of purchase, nearest Westermo distributor office or Westermo Tech support.

Maintenance

No maintenance is required, as long as the unit is used as intended within the specified conditions.

Product disposal



This symbol means that the product shall not be treated as unsorted municipal waste when disposing of it. It needs to be handed over to an applicable collection point for recycling electrical and electronic equipment.

By ensuring this product is disposed of correctly, you will help to reduce hazardous substances and prevent potential negative consequences to both environment and human health, which could be caused by inappropriate disposal.

Simplified EU declaration of conformity

Hereby, Westermo declares that the equipment is in compliance with applicable EU directives. The full EU declaration of conformity and other detailed information are available at the respective product page at www.westermo.com.

Agency approvals and standards compliance

Type		Approval/Compliance	
RED	Article 3.1a	EN 60950-1	Safety
		EN 50385	EMF exposure
	Article 3.1b	EN 301 489-1	ERM/EMC
		EN 301 489-7	ERM/EMC GSM
		EN 301 489-24	ERM/EMC 3G
	Article 3.2	EN 301 908-1	ERM 3G
		EN 301 908-2	ERM 3G
		EN 301 511	GSM
Safety		IEC/EN 60950-1, IT equipment	

Type tests and environmental conditions

Phenomena	Test	Description	Test levels	
ESD	EN 61000-4-2	Enclosure, contact	± 6 kV	
		Enclosure, air	± 8 kV	
RF field AM modulated	IEC 61000-4-3	Enclosure	10 V/m (80 – 2700 MHz)	
Fast transient	EN 61000-4-4	Signal ports	MRD-315/415/355	± 1 kV
			MRD-455	± 2 kV
		Power ports		± 2 kV
Surge	EN 61000-4-5	Signal ports	MRD-315/415/355	± 1 kV (Crit. B)
			MRD-455	± 2 kV
		Power ports	MRD-315/415/355	± 0.5 kV (Crit. B)
			MRD-455	± 2 kV
RF conducted	EN 61000-4-6	All ports	10 V/m (0.15 – 80 MHz)	
Conducted magnetic Fields	EN 61000-4-8	Only MRD-455	10 A/m*	
DC Voltage DIPS	EN 61000-4-29		12VDC and 24VDC up to 300ms (A), 1s (B)*	
Radiated emission	CISPR 16-2-3 ANSI C63.4 (FCC part 15)	Enclosure	Class B	
Conducted emission	CISPR 16-2-1 ANSI C63.4 (FCC part 15 b)	Power port	Class B	
		Signal ports	Class B	
Environmental				
Temperature	EN 60068-2-1 EN 60068-2-2	Operating	-40 to +70°C	
		Storage & Transport	-40 to +85°C	
Humidity	EN 60068-2-30	Operating	0 to 95% relative humidity non condensing.	
		Storage & Transport	0 to 95% relative humidity non condensing.	
Altitude		Operating	2000 m/70 kPa	
Service life		Operating	10 year	
Reliability prediction (MTBF)	MIL-217-F	MRD-315	825 700 hours	
		MRD-415	1 367 200 hours	
		MRD-355	689 900 hours	
		MRD-455	911 600 hours	
Vibration	IEC 61373			
Packaging				
Enclosure			Aluminium	
Dimension W x H x D		MRD-315/415	103 x 32 x 156 mm	
		MRD-355/455	53 x 103 x 134 mm	
Weight		MRD-315/415	0.30 kg	
		MRD-355, MRD-455	0.40 kg	
Degree of protection	EN 60529	Enclosure	IP40	
Cooling			Convection	
Mounting			Horizontal on 35 mm DIN-rail	

Product description

The MRD-315/415 and MRD-355/455 Industrial Cellular Routers make full use of the 2G, 3G and 4G cellular networks to cost effectively inter-connect systems, sites and operators. Creating a solid foundation for smart automated systems, where machines can communicate with machines and service technicians can remotely monitor and maintain their valuable assets in any system.

Devices connected to the Internet require countermeasures towards cybersecurity threats.

The MRD-series offers protection of transmissions from malicious eavesdroppers via encrypted communication tunnels (VPN), and features a simple, yet powerful, packet inspection firewall.

Configuration of the device is done with a simple and intuitive Web-interface, management is also available with a basic CLI and SMS messages can be used for controlling the device and receiving status updates.

The products feature a built in 2-port ethernet switch for connecting to any Ethernet device. For legacy support there is also a built-in serial port that offers a simple modem replacement solution with the benefit of not having to reprogram or change any other component.

Features such as connection maintenance and network to network roaming ensures a very high availability and connection that is always available. Which is crucial in mission critical installations, where even the shortest downtime can prove very costly.

MRD-315 and MRD-415

The MRD-315 and MRD-415 comes in a very slim and robust casing which is ideal for wall mounting in small spaces, taking up very little space in a cabinet or similar. Connections come out on each end of the unit, with antenna connectors on one side and Ethernet and Serial interfaces on the other.

It features a very low power consumption, making it the ideal choice for battery or solar powered applications. Low power consumption combined with a clever power saving feature allow the unit to run for a long time without the battery.

MRD-355 and MRD-455

The MRD-355 and MRD-455 comes in a very compact and robust casing which is ideal for mounting on DIN-rails. All connections and LEDs are located on the front making it ideal for installation in industrial cabinets and applications.

To further strengthen the already high availability they feature dual-SIM card slots, allowing the user to remove carrier dependency and swapping operators automatically if the primary run into trouble. They also feature a galvanic isolation between all interfaces (power supply, ethernet, serial), to protect the unit against electrical surges and overvoltage which is common in many industrial applications.

Available Models

Art.no.	Description
3623-0050	MRD-315 Industrial 3G router
3623-0515	MRD-415, Industrial cellular router
3623-0250	MRD-355 Industrial Mobile Broadband Router (3G) with dual SIM support
3623-0401	MRD-455 Industrial Mobile Broadband Router (4G LTE) with dual SIM support

Interface specifications for all MRDs

Power	
Rated voltage	12 – 48 VDC
Operating voltage	10 – 60 VDC
Rated frequency	DC
Start-up current (max)	400 mA
Polarity	Reverse polarity protected
Isolation to	All other*
Connection	Detachable screw terminal
Shielded cable	Not required

Ethernet TX	
Electrical specification	IEEE std 802.3. 2005 Edition
Data rate	10 Mbit/s, 100 Mbit/s, auto
Duplex	Full or half, auto
Circuit type	SELV
Transmission range	100 m/328 ft
Isolation to	All other
Connection	RJ-45, auto MDI/MDIX
Shielded cable	Not required, except when installed in Railway applications as signalling and telecommunications apparatus and located close to rails.*
Conductive housing	Yes
Number of ports	2

*Only MRD-355/455

RS-232	
Electrical specification	EIA RS-232
Data rate	300 bit/s – 115.2 kbit/s
Data format	7 or 8 data bits, Odd, even or none parity, 1 or 2 stop bits
Protocol	Transparent, optimised by packing algorithm
Circuit type	SELV
Transmission range	15 m (49 ft)
Connection	9 pin D-sub female
Shielded cable	Not required
Conductive housing	Yes
Number of ports	1

Cellular interface			
Technology	MRD-315 & MRD-355	MRD-415	MRD-455
	Frequency band (MHz)	Frequency band (MHz)	Frequency band (MHz)
2G	GSM 850, GSM 900, DCS 1800, PCS 1900	GSM 900, DCS 1800	GSM 900, DCS 1800
3G	B1, B2, B4, B5, B8	B1, B3, B8	B1, B5, B8
4G	-	B2, B3, B7, B8, B20, B28A	B1, B3, B5, B7, B8, B20, B38, B40, B41
Category	HSPA Cat. 14/6	LTE Cat.1	LTE Cat.4

Protocols and Functionality

Ethernet Technologies	IEEE 802.3 for 10BaseT IEEE 802.3u for 100BaseTX
Serial Port Technologies	RS-232 Serial Over IP (Serial Extender and Virtual Serial Port) Router emulation AT command interpreter MODBUS DNP3
Layer-2 QoS	IEEE 802.1p Class of Service
IP Routing, Firewall, VPN and Cyber Security	Static IP routing Dynamic IP routing <ul style="list-style-type: none"> • RIPv1/v2 VRRP GRE Stateful inspection Firewall/ACL, NAT, Port Forwarding 25 x IPsec VPN, PSK & X.509* 1 x L2TP client 1 x PPTP client 1 x OpenVPN/SSL VPN client RADIUS PPP Dial in/Dial out
Manageability	Management tools <ul style="list-style-type: none"> • Web interface (HTTP and HTTPS) • Command Line Interface (CLI) via SSHv2 and TELNET • SNMPv1/v2c/v3 • SMS Control Flexible alarm/event handling system Syslog (log files and remote syslog server) SNTP (NTP client) DHCP client DHCP server DDNS (Dynamic DNS update client)

* 25 x Configurable IPsec VPNs, processing power in relation to traffic over VPN sets limitation on number of VPNs.

Hardware Overview

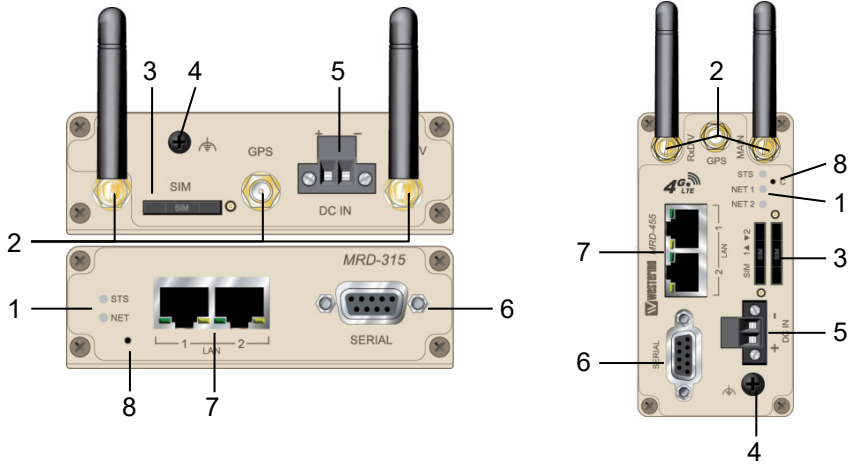

Position	Description	Position	Description
1	LED indicators	5	Power connector
2	Antenna Connectors	6	Serial Port
3	SIM-card drawer(s)	7	Ethernet TX ports
4	Protective Earth	8	Factory Reset Switch

Connector Pinout

Ethernet

The Ethernet ports are on the front of the unit and are marked LAN 1 and LAN 2, each port has a LED indicating the connection speed and a LED indicating activity as shown in figure below. Both ports are capable of auto-negotiation, meaning cross-over cables are not required. The Ethernet ports are switched, allowing more than one Ethernet device to be connected to the unit at one time

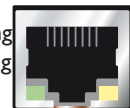

Ethernet TX Connections (RJ-45 connector) LAN1-2

Position	Direction	Description
1	In/Out	TD+
2	In/Out	TD-
3	In/Out	RD+
4	-	Not Connected
5	-	Not Connected
6	In/Out	RD-
7	-	Not Connected
8	-	Not Connected

DC connection

Position	Product marking	Direction	Description
1	-	Input	Common
2	+	Input	Supply voltage input DC

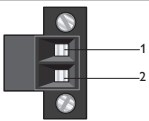

Serial Port (DCE Female)

Position	Name	Direction	Description
1	DCD	Out	Data Carrier Detect
2	RxD	Out	Receive Data
3	TxD	In	Transmit Data
4	DTR	In	Data Terminal Ready
5	SG	-	Signal Ground
6	DSR	Out	Data Set Ready
7	RTS	IN	Request to Send
8	CTS	Out	Clear to Send
9	RI	Out	Ring Indicator



LED Indicators

LED	Status	Description	
STS Status	RED	No wireless network has been detected	
	RED FLASH	A wireless network has been detected	
	GREEN	Power up self test OK/no issues	
NET NET 1 NET 2 Network indicator	OFF	Not ready	
	RED	RF circuitry initialising or network registration fault	
	GREEN/RED	Network connection fault	
	GREEN FLASH	Searching for network	
	GREEN	Locked to network	
	GREEN 1 BLINK	Signal strength indication	
	GREEN 2 BLINKS		
	GREEN 3 BLINKS		
	GREEN 4 BLINKS		1 Very poor
	GREEN 5 BLINKS		3 Normal
GREEN 6 BLINKS	6 Very good		



Mounting

The MRD-355 and MRD-455 should be mounted on 35 mm DIN-rail, which is horizontally mounted inside an apparatus cabinet or similar. Snap on mounting, see figure.

Mount the MRD-355 and MRD-455 with integrated DIN-clip:

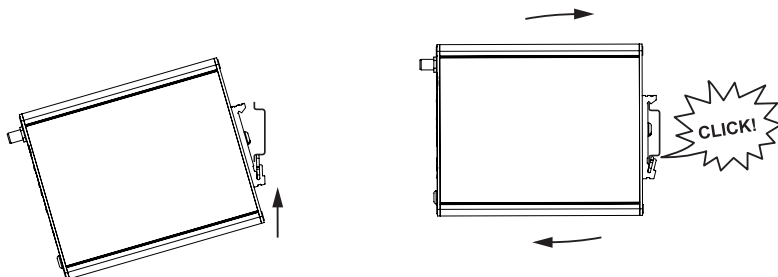

The MRD-315 and MRD-415 includes integrated mounting flanges and can be attached to a panel or tray by means of screws, using the slots provided. Alternatively the MRD-315 and MRD-415 can be DIN rail mounted, using the DIN rail mounting kit.

Earth connection

For correct function, the ground connection on the unit needs to be properly connected to a solid ground. See figure.

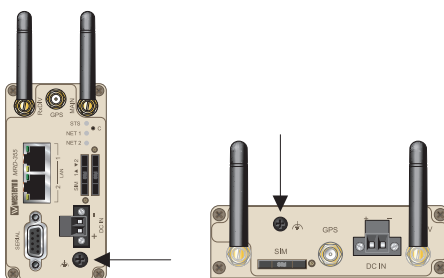

Cooling

The router should be mounted in a clean and dry location, protected from water, excessive dust, corrosive fumes, extremes of temperature and direct sunlight. Allow sufficient ventilation to ensure adequate cooling of the router.

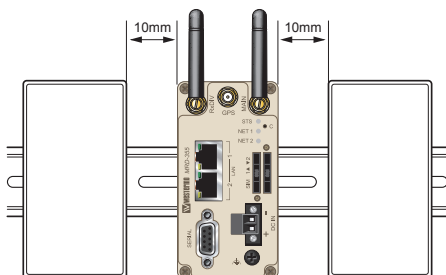

Getting started

All configuration of the MRD can be done via the web interface. In order to view the web pages a computer with a fixed IP address, on the same sub-net as the MRD, will need to be connected to one of the LAN ports.

The default IP settings of the MRD are:

IP Address: 192.168.2.200

Netmask: 255.255.255.0

Note: The DHCP server of the unit is by default disabled.

Accessing the MRD

- Open a web browser on the PC and browse to <http://192.168.2.200> (the default MRD, IP address) .
- A login box will popup. If the box fails to display, re-check the cable connections to the unit and the IP address settings of the PC.

Enter the following login details:

- User Name: admin
- Password: westermo
- The Status summary page will be displayed.

Installing the SIM Card

- ⌘ To eject the SIM card drawer, press the SIM card eject button using a suitable tool and remove the drawer, refer to figure for the location of the SIM card eject button.
- ⌘ Insert the SIM card into the SIM card drawer with the contacts facing up, let chamfered corners align.
- ⌘ Slide the drawer back into the unit ensuring that it locks into place.

Note: Before removing or inserting the SIM card, ensure that the power has been turned off and the power connector has been removed from the MRD.

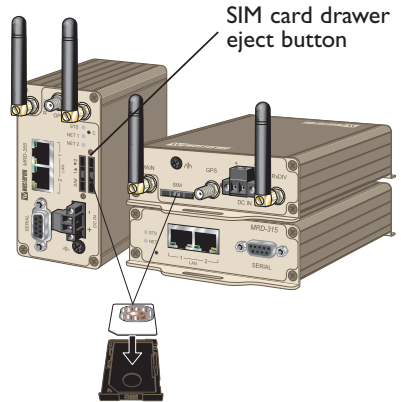

Antenna(s)

The units have three antenna connectors (SMA). Please ensure that the connecting nut is done up tightly in order to make a good connection.

Power Supply

The MRD requires a DC power source in the voltage range of 10 to 60 VDC. The unit is designed to self protect from permanent damage if the voltage exceeds 60 VDC or if reverse polarity is applied. The router may need to be returned for service if this occurs. The router can also be damaged if there is any potential difference between the chassis-ground, RS-232 signal ground, power (-) input, or antenna shield. Before connecting any wiring, ensure all components are earthed to a common ground point. An external isolator will be required if a positive earth power supply is used.

Factory Default Reset Switch

The reset switch is used to restore the configuration of the MRD to factory default settings. The switch is accessed through a small hole on the rear of the unit adjacent to the power connector.

To reset the configuration:

- Power down the unit.
- Use a suitable tool and depress the reset switch.
- Power up the unit ensuring the switch remains depressed for approximately 10 seconds after power is applied. The STS LED and NET LED will flash twice to indicate a reset.
- The router will now re-boot as normal with the factory default settings.

Note: Using the Factory Default Reset Switch will erase all existing configuration settings and restore the factory default settings. This includes the network connection profile settings APN, user name and password.

Dimensions MRD-315 and MRD-415

Measurements are stated in millimeters.

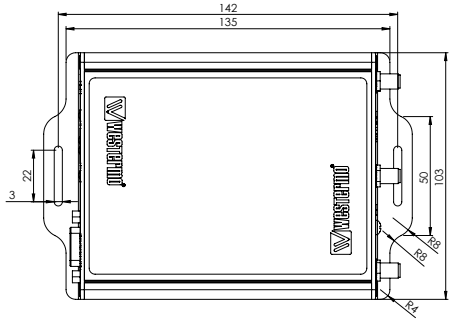
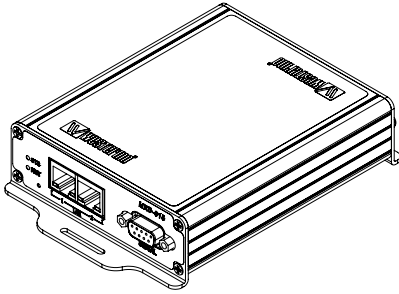
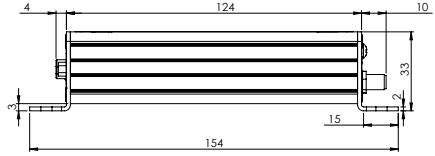
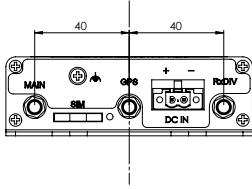

Dimensions MRD-355 and MRD-455

Measurements are stated in millimeters.

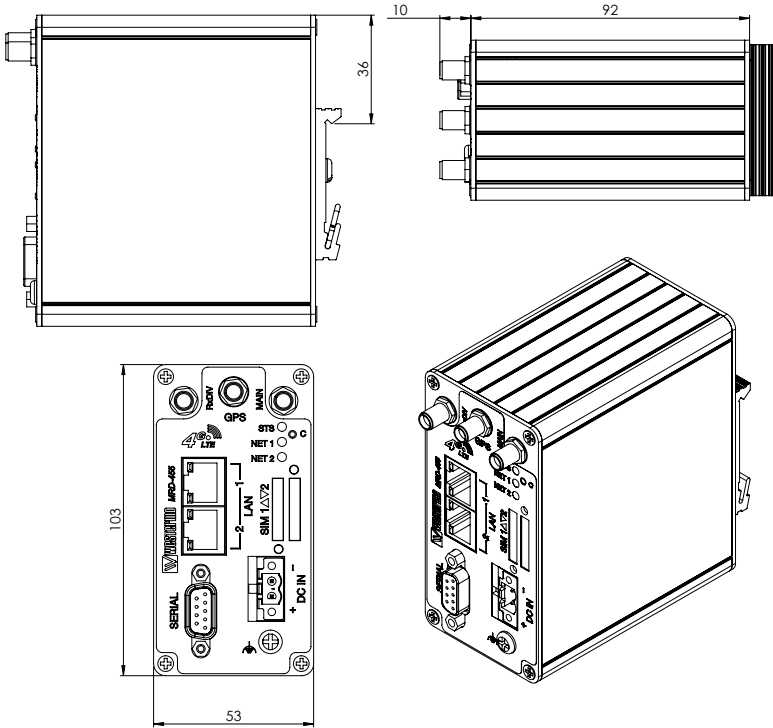



Westermo • SE-635 35 Stora Sundby, Sweden
Tel +46 16 42 80 00 Fax +46 16 42 80 01
E-mail: info@westermo.com
www.westermo.com